



Universidade de Évora - Escola de Ciências Sociais

Mestrado em Arqueologia e Ambiente

Área de especialização | Avaliação de Impacte Ambiental

Dissertação

Volume II

**Dinâmicas de enchimento do Fosso 3 do Complexo
Arqueológico dos Perdigões. Abordagem através da
componente cerâmica e lítica**

Inês Isabel Rosa Ribeiro

Orientador(es) | Leonor Rocha

António Carlos Neves de Valera

Évora 2023



Universidade de Évora - Escola de Ciências Sociais

Mestrado em Arqueologia e Ambiente

Área de especialização | Avaliação de Impacte Ambiental

Dissertação

Volume II

**Dinâmicas de enchimento do Fosso 3 do Complexo
Arqueológico dos Perdigões. Abordagem através da
componente cerâmica e lítica**

Inês Isabel Rosa Ribeiro

Orientador(es) | Leonor Rocha

António Carlos Neves de Valera

Évora 2023





A dissertação foi objeto de apreciação e discussão pública pelo seguinte júri nomeado pelo Diretor da Escola de Ciências Sociais:

Presidente | Jorge Manuel Oliveira (Universidade de Évora)

Vogais | Leonor Rocha (Universidade de Évora) (Orientador)
Mariana Diniz (Universidade de Lisboa - Faculdade de Letras) (Arguente)

Índice de Anexos

Anexo I Escavação	2
Anexo II Distribuição das tipologias cerâmicas e componentes de ter por Unidades Estratigráficas	6
Anexo III Distribuição dos Líticos por Unidade Estratigráfica	15
Anexo IV Cerâmicas- Tipologias	21
Anexo V Componentes de Tear	52
Anexo VI Líticos- Fotografias	54
Anexo VII Cerâmicas - Fotografias.....	64

Anexo I
Escavação



Figura 1: Divisão da área do Complexo Arqueológico dos Perdígões por Sectores de A a Z
Fonte: Valera, 2008



Figura 2: Planta Geral com implantação das estruturas negativas identificadas
Fonte: Valera, 2008

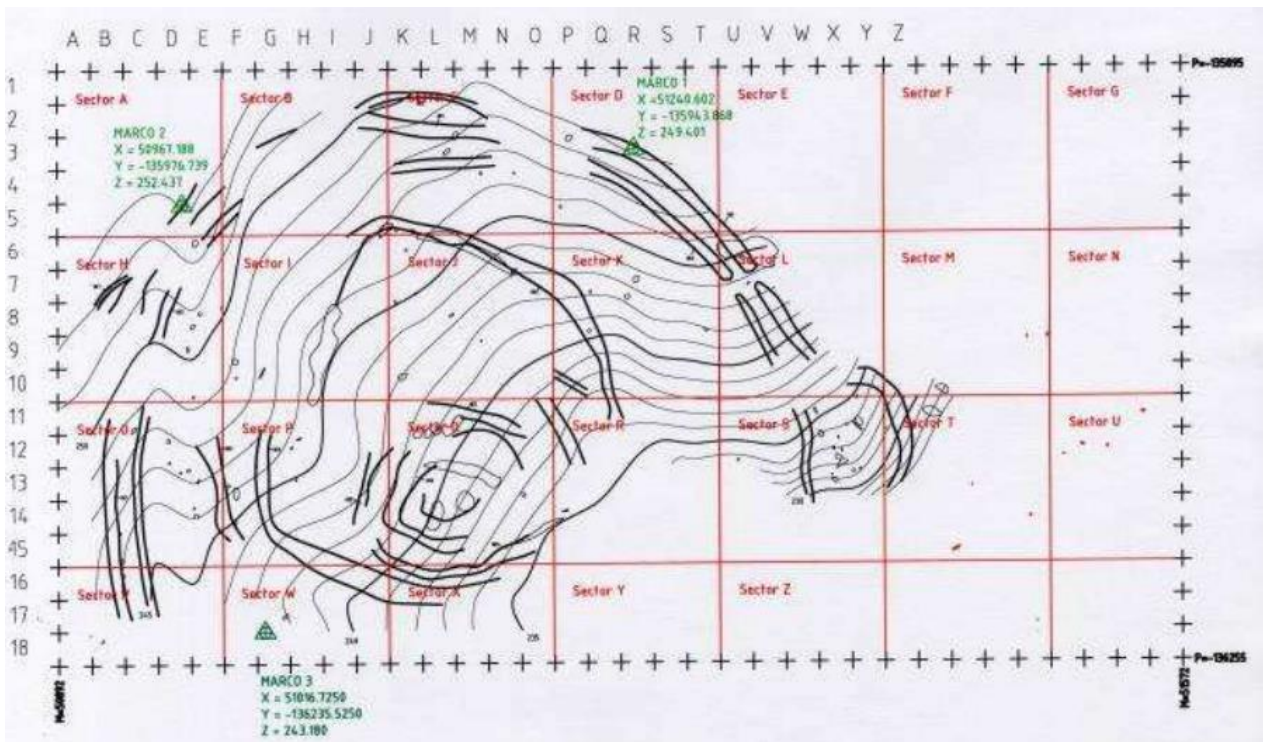

Figura 3: Aspecto do corte Norte (imagem da esquerda) e Corte Sul (imagem da direita) do Fosso 3
Fonte: Valera, 2008

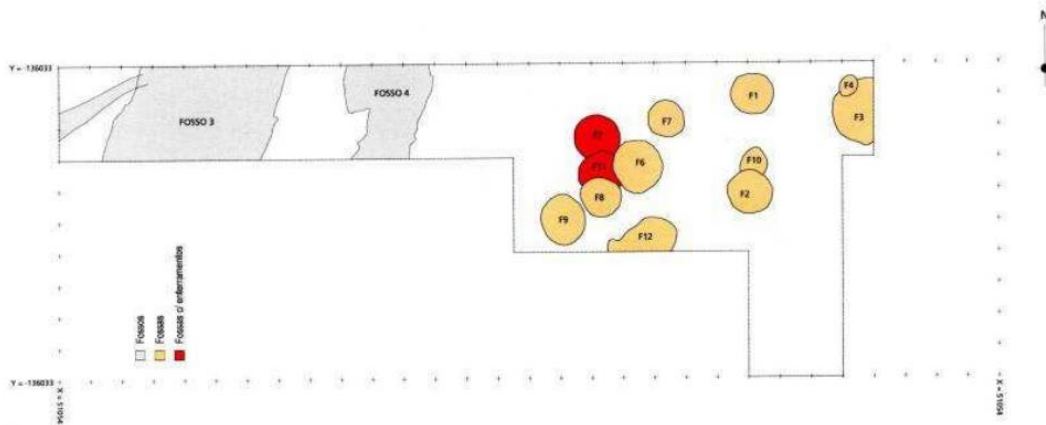

Figura 4: Dois momentos de deposição horizontal de líticos, fragmentos cerâmicos e fauna
Fonte: Valera, 2008



Figura 5: Deposição do Vaso de Suporte e seixos rolados na [UE58]
Fonte: Valera, 2008



Figura 6: Deposição de dois crânios de canídeos
Fonte: Valera, 2008



Figura 7: Depósitos finais de enchimento do Fosso 3 (imagem esquerda) e do canal de erosão (imagem direita)
Fonte: Valera, 2008

Anexo II

Distribuição das tipologias cerâmicas e componentes de tear por Unidades Estratigráficas



Gráfico 1: Tipologias presentes na Unidade Estratigráfica [UE16]



Gráfico 2: Tipologias presentes na Unidade Estratigráfica [UE20]

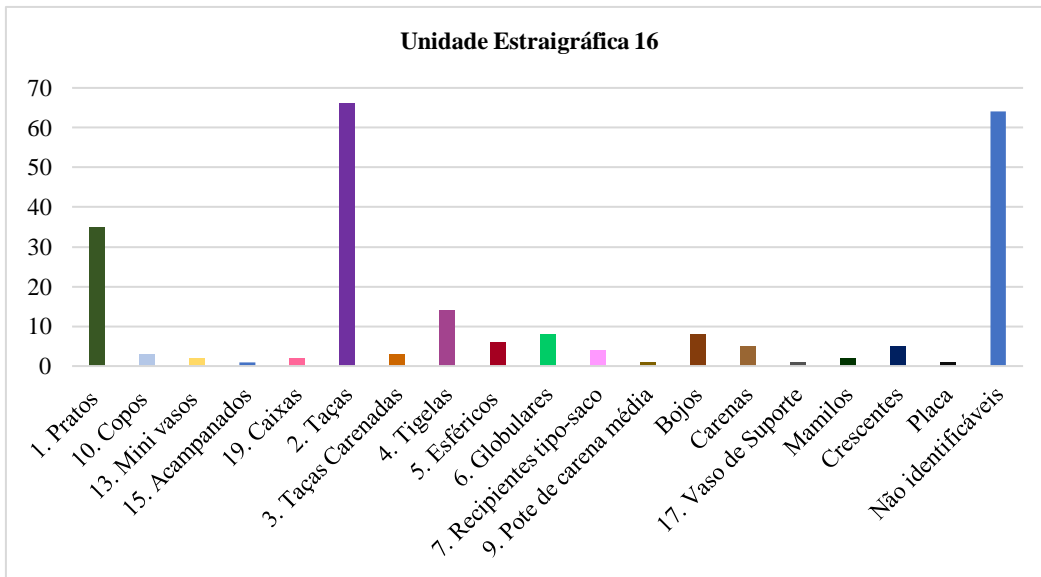

Gráfico 3: Tipologias presentes na Unidade Estratigráfica [UE28]

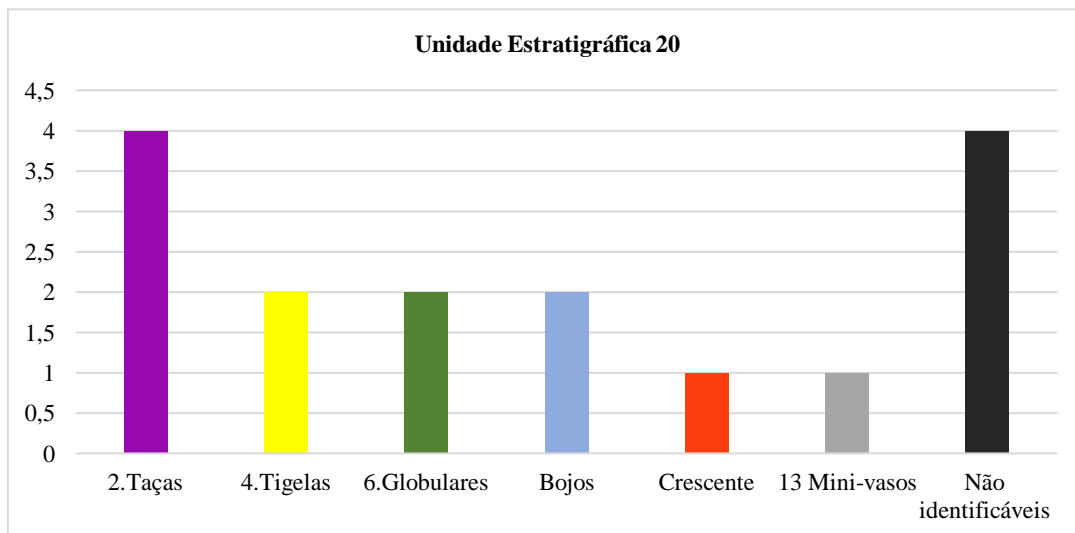

Gráfico 4: Tipologias presentes na Unidade Estratigráfica [UE30]

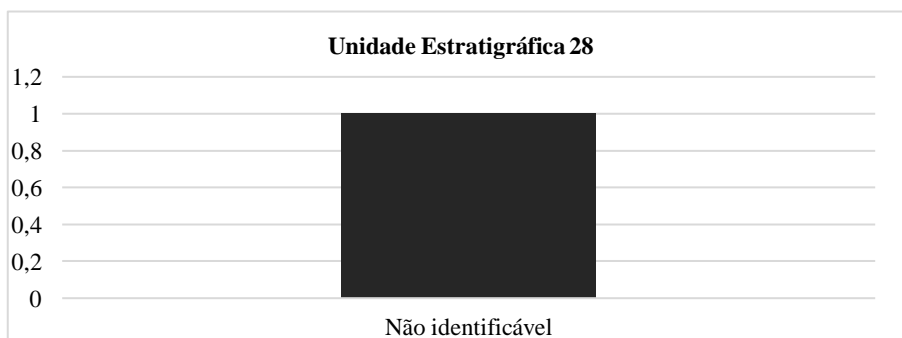

Gráfico 5: Tipologias presentes na Unidade Estratigráfica [UE32]

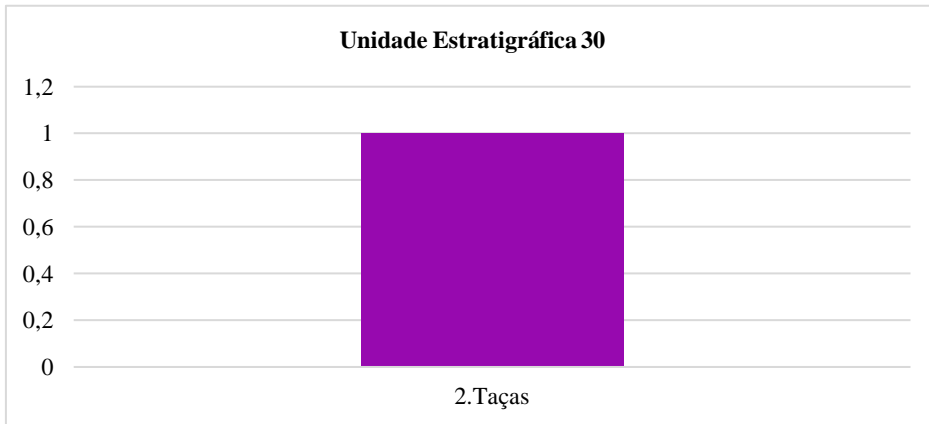

Gráfico 6: Tipologias presentes na Unidade Estratigráfica [UE37]

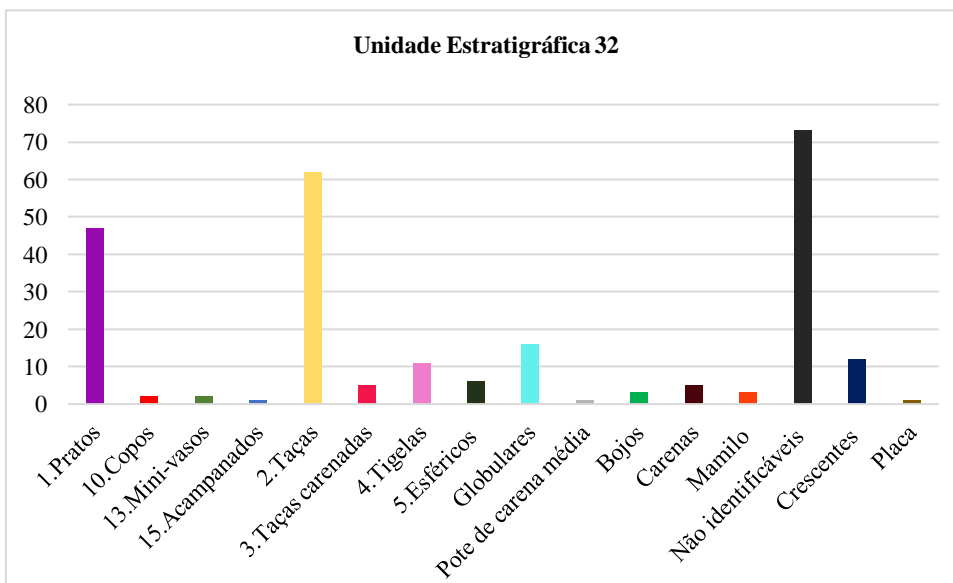

Gráfico 7: Tipologias presentes na Unidade Estratigráfica [UE 38]

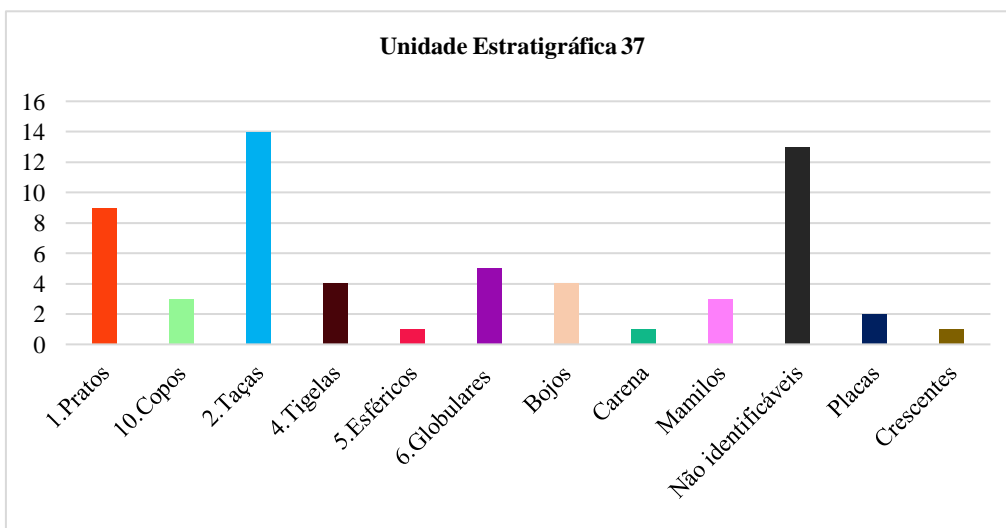

Gráfico 8: Tipologias presentes na Unidade Estratigráfica [UE58]

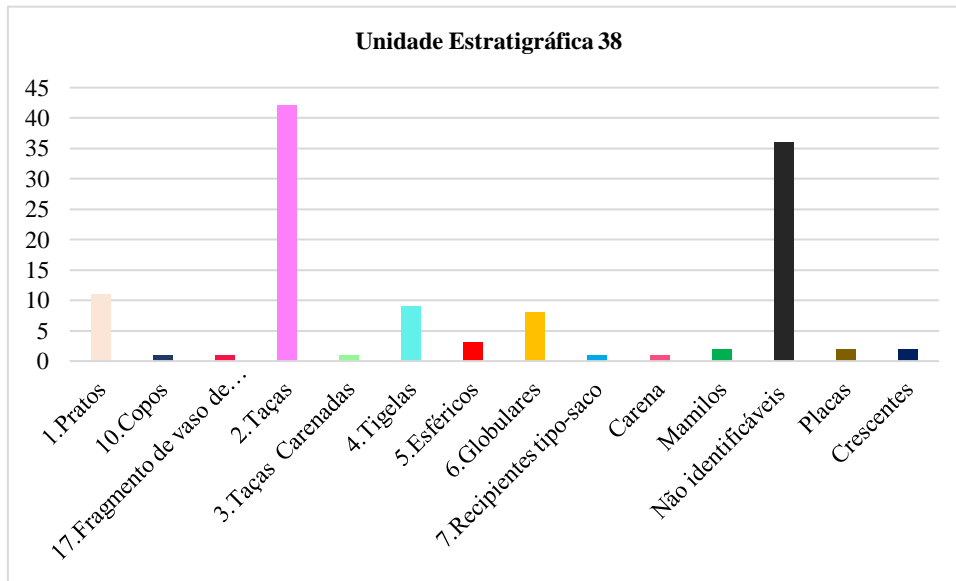

Gráfico 9: Tipologias presentes na Unidade Estratigráfica [UE60]

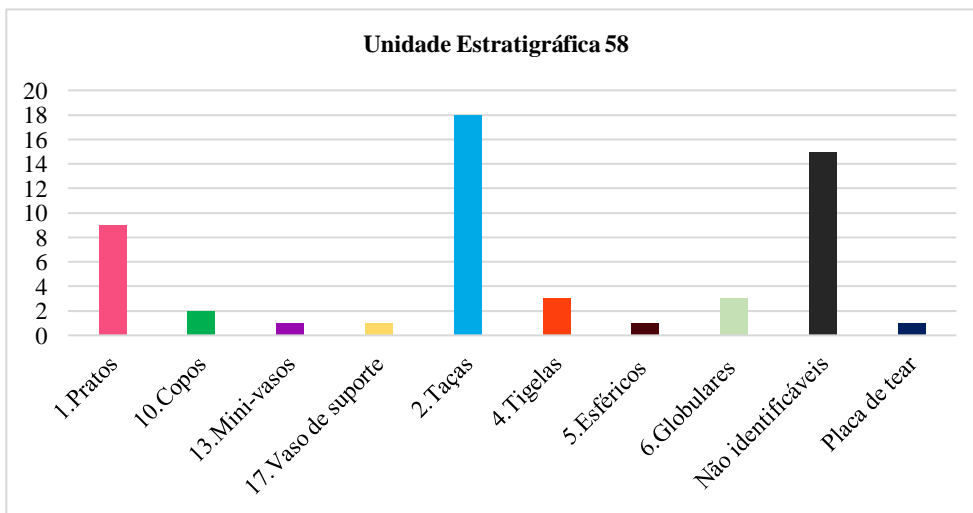

Gráfico 10: Tipologias presentes na Unidade Estratigráfica [UE 67]

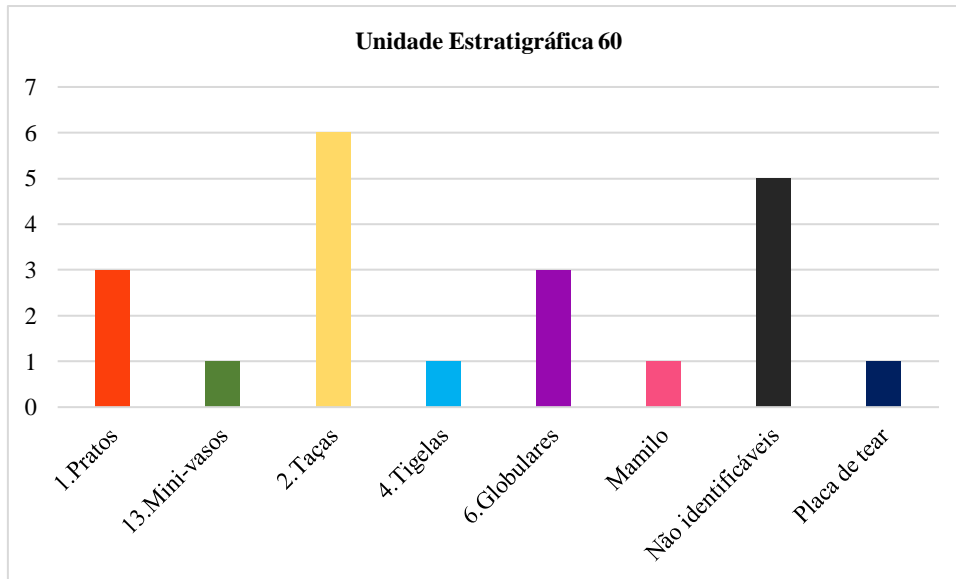

Gráfico 11: Tipologias presentes na Unidade Estratigráfica [UE 75]

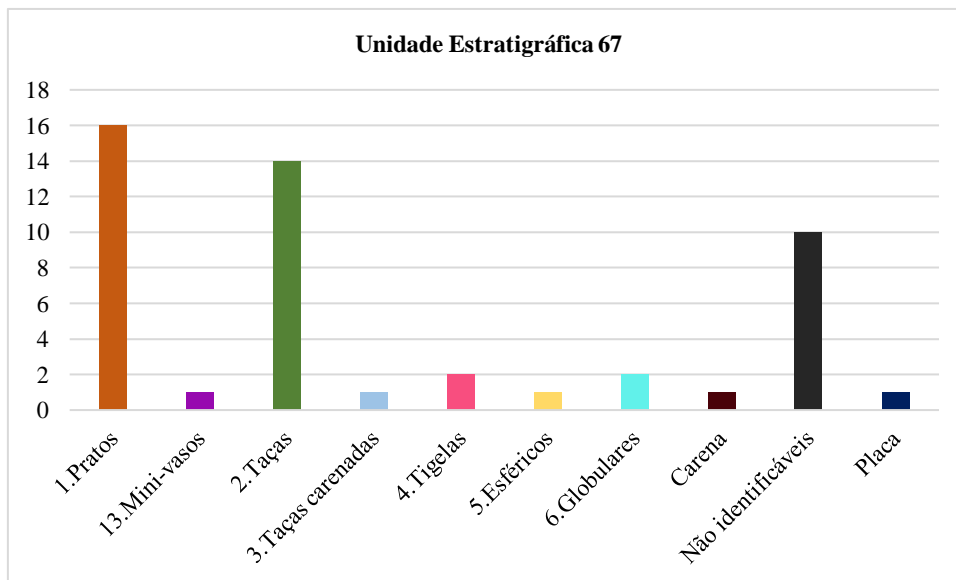

Gráfico 12: Tipologias presentes na Unidade Estratigráfica [UE82]

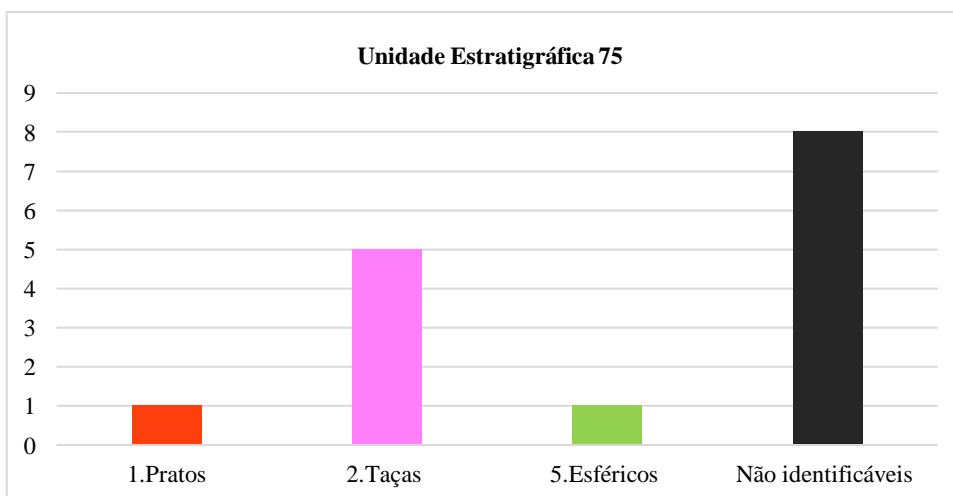

Gráfico 13: Tipologias presentes na Unidade Estratigráfica [UE83]

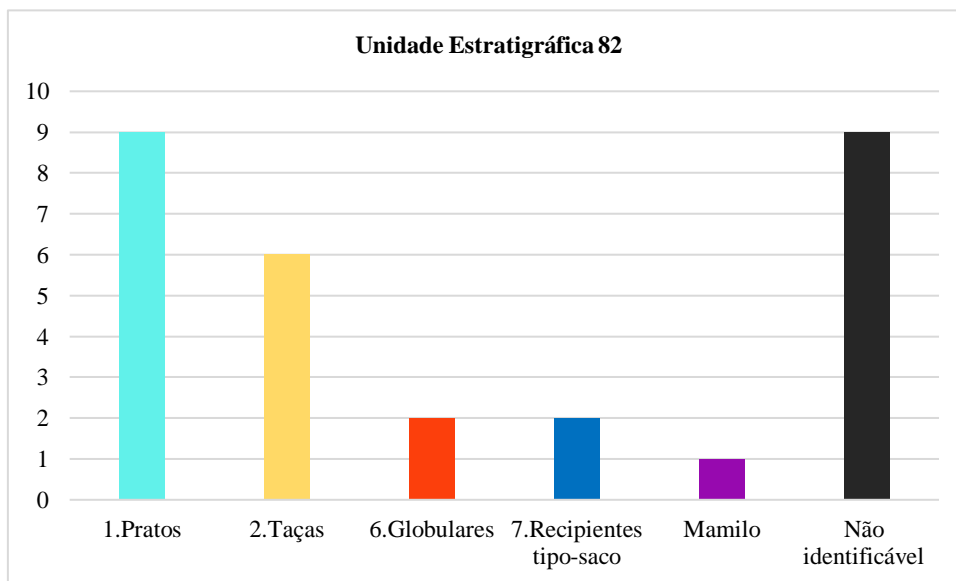

Gráfico 14: Tipologias presentes na Unidade Estratigráfica [UE84]

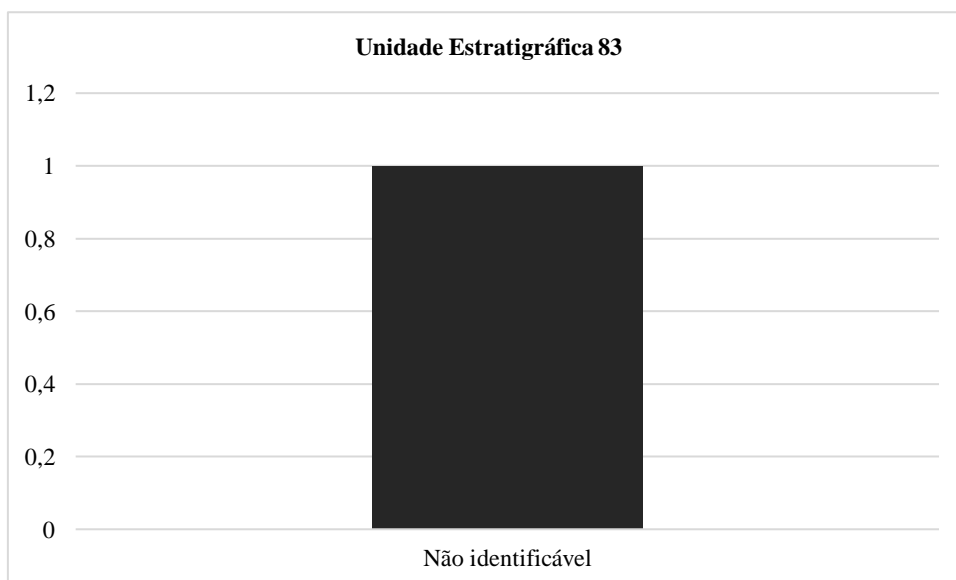

Gráfico 15: Tipologias presentes na Unidade Estratigráfica [UE87]

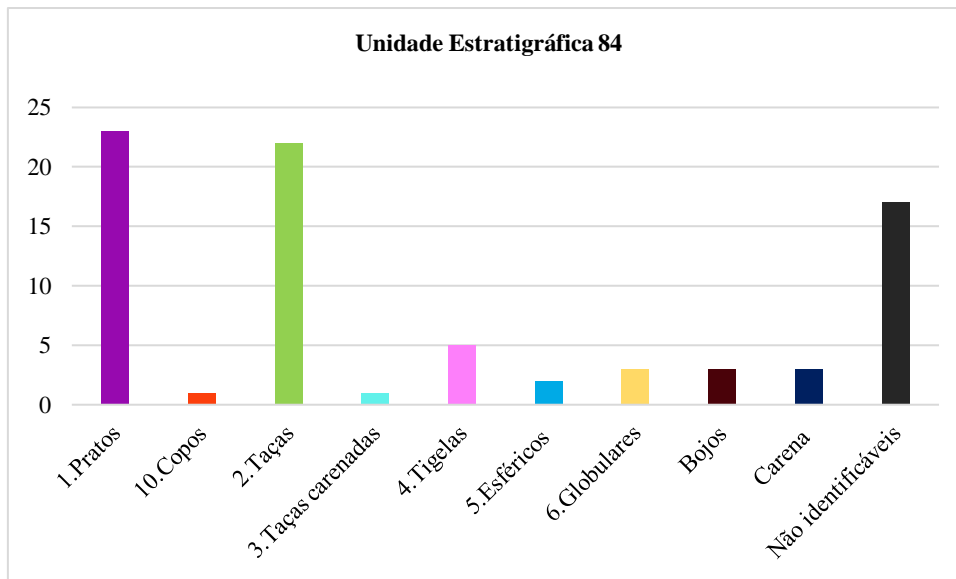

Gráfico 16: Tipologias presentes na Unidade Estratigráfica [UE92]

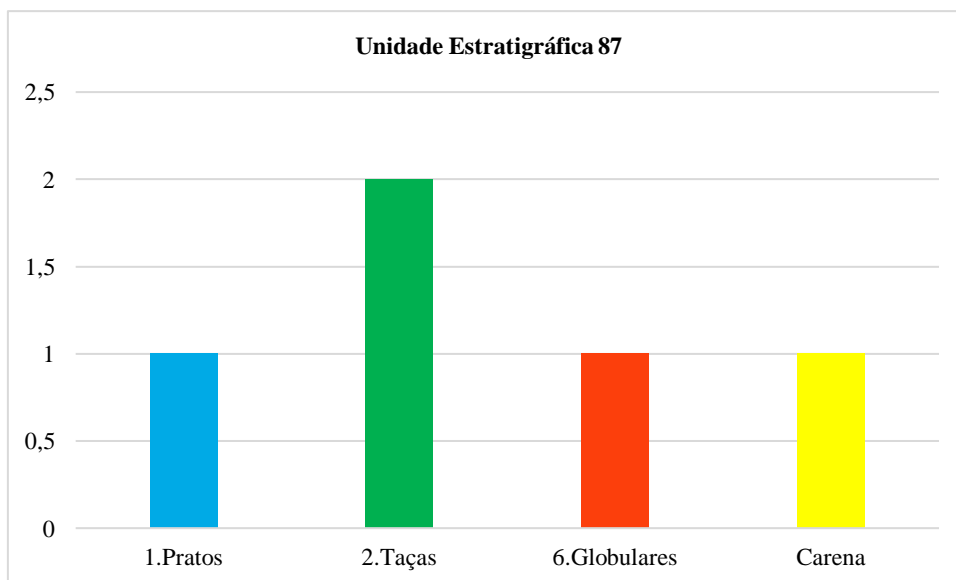

Gráfico 17: Tipologias presentes na Unidade Estratigráfica [UE93]

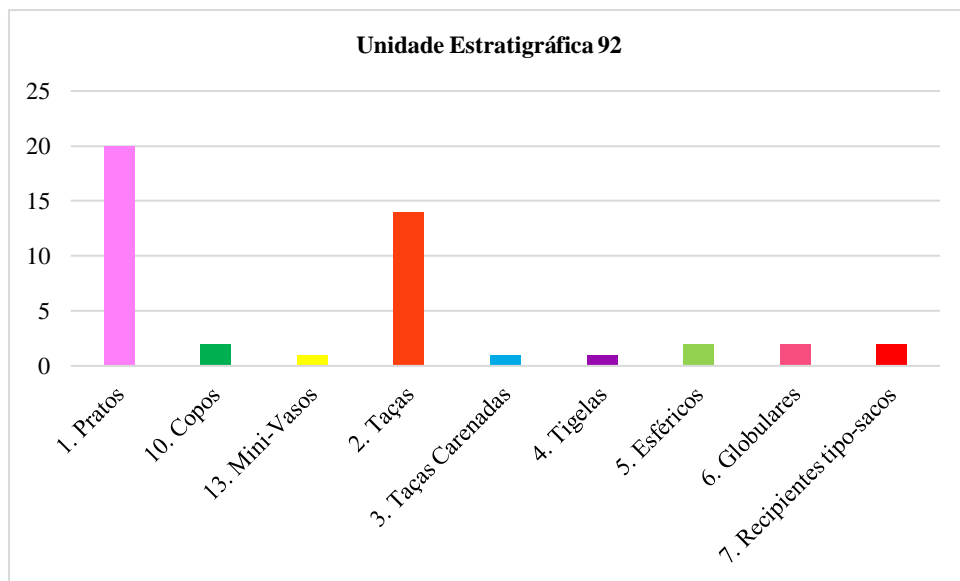

Gráfico 18: Tipologias presentes na Unidade Estratigráfica [UE94]

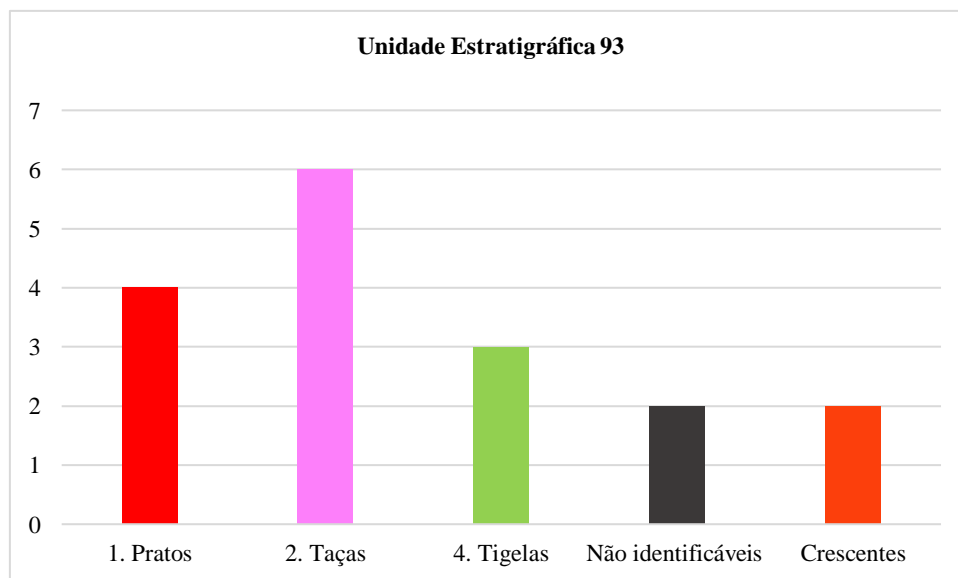

Gráfico 19: Tipologias presentes na Unidade Estratigráfica [UE99]

Anexo III

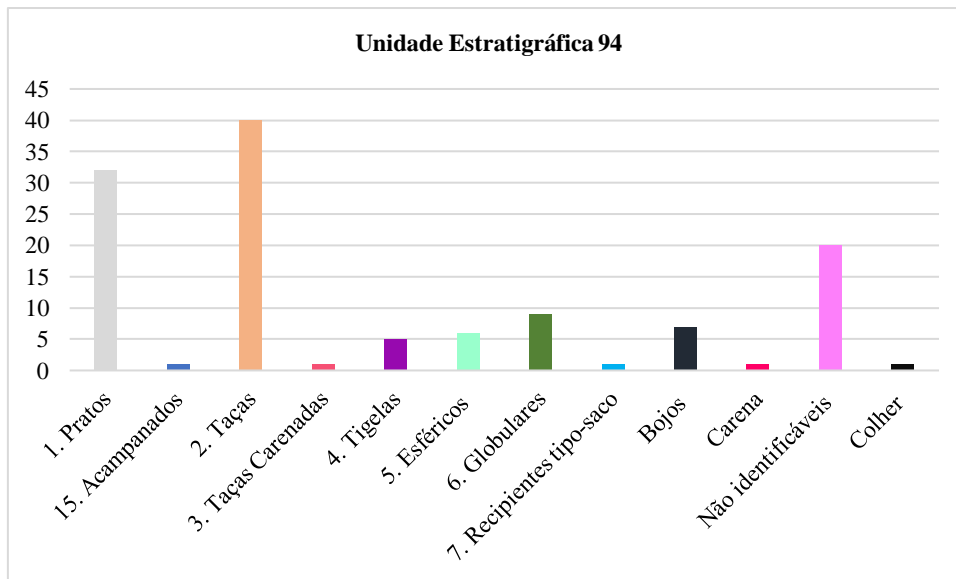
Distribuição dos Líticos por Unidade Estratigráfica

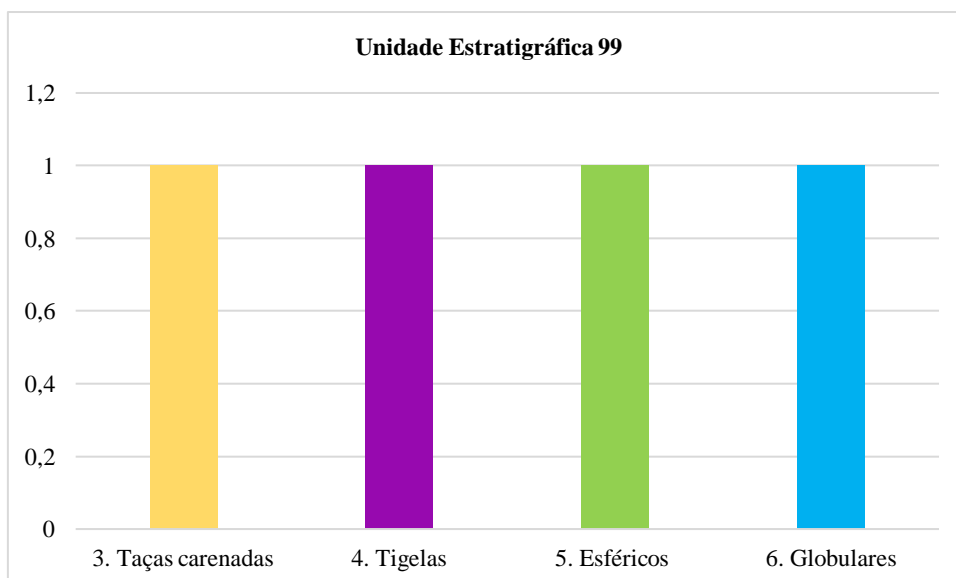

Gráfico 20: Líticos presentes na Unidade Estratigráfica [UE16]



Gráfico 21: Líticos presentes na Unidade Estratigráfica [UE20]

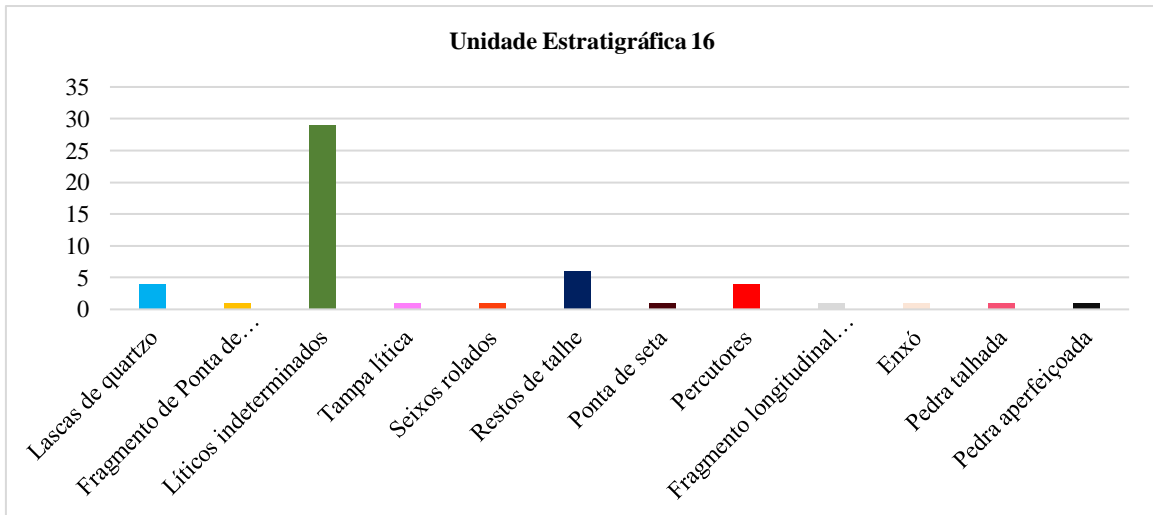

Gráfico 22: Líticos presentes na Unidade Estratigráfica [UE32]

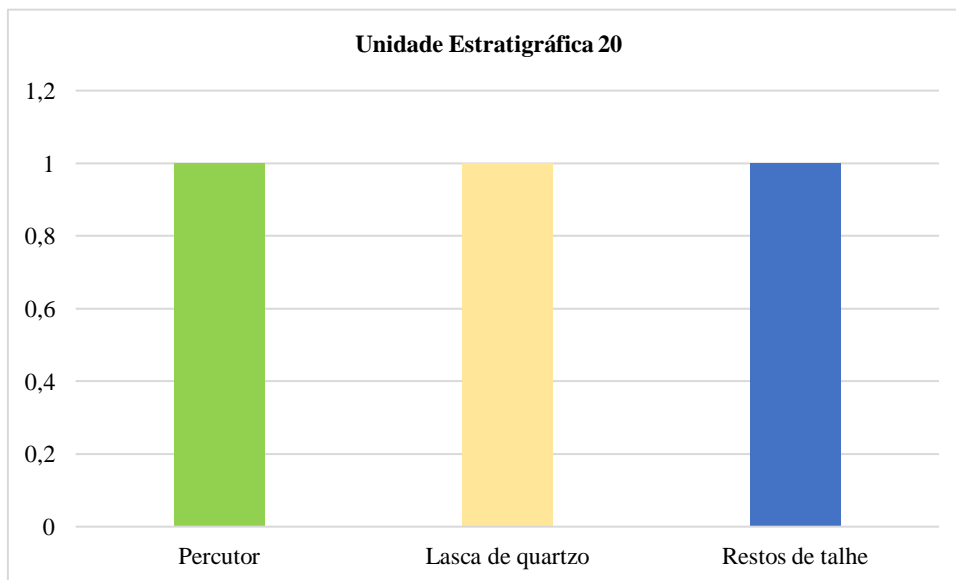

Gráfico 23: Líticos presentes na Unidade Estratigráfica na [UE37]

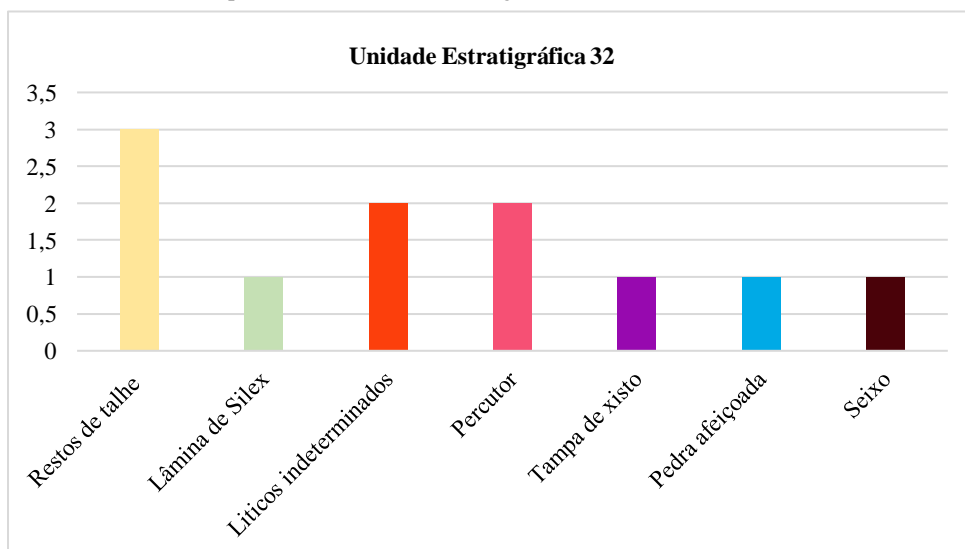

Gráfico 24: Líticos presentes na Unidade Estratigráfica na [UE58]

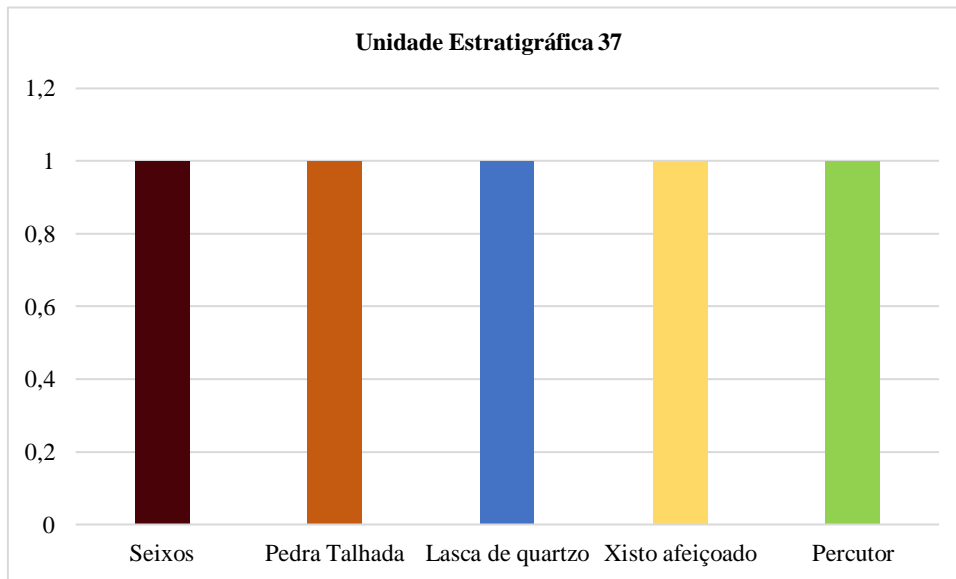

Gráfico 25: Líticos presentes na Unidade Estratigráfica na [UE82]

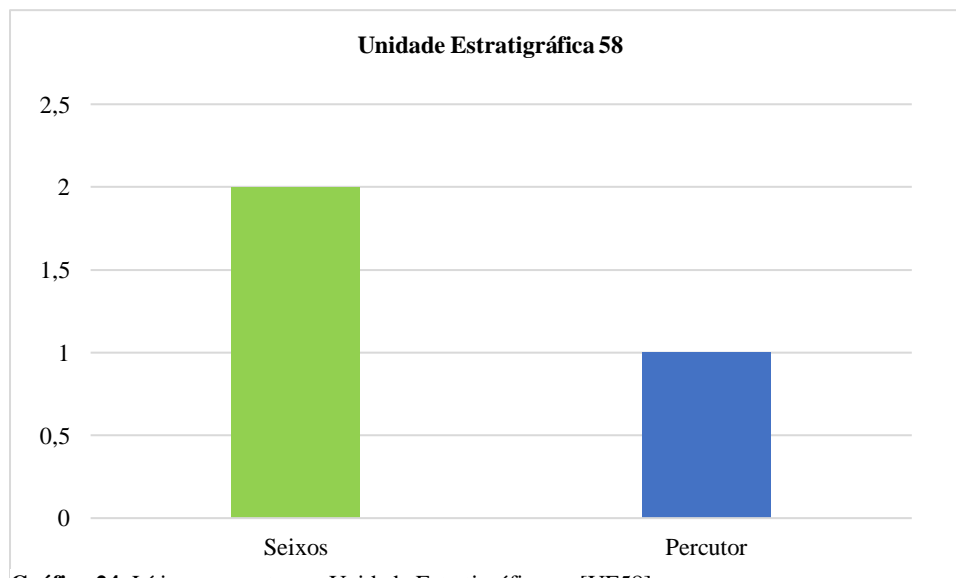

Gráfico 26: Líticos presentes na Unidade Estratigráfica [UE92]

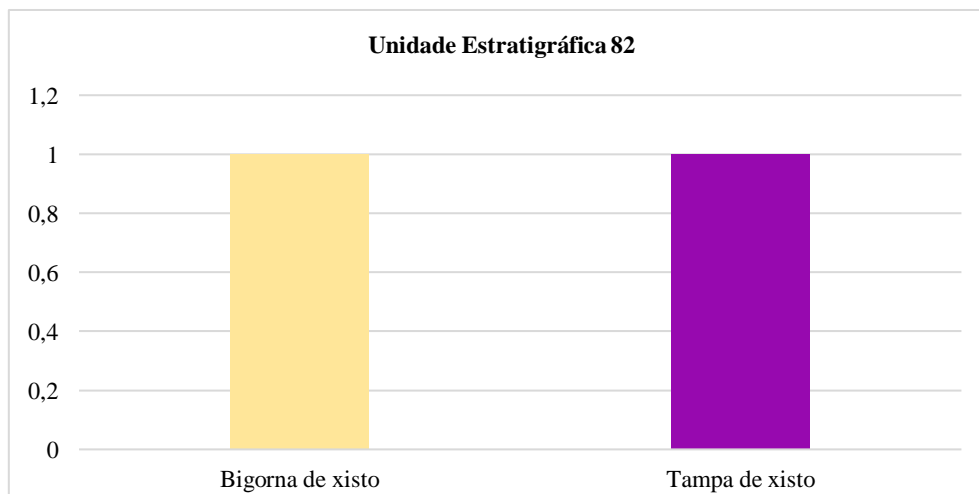

Gráfico 27: Líticos presentes na Unidade Estratigráfica [UE93]

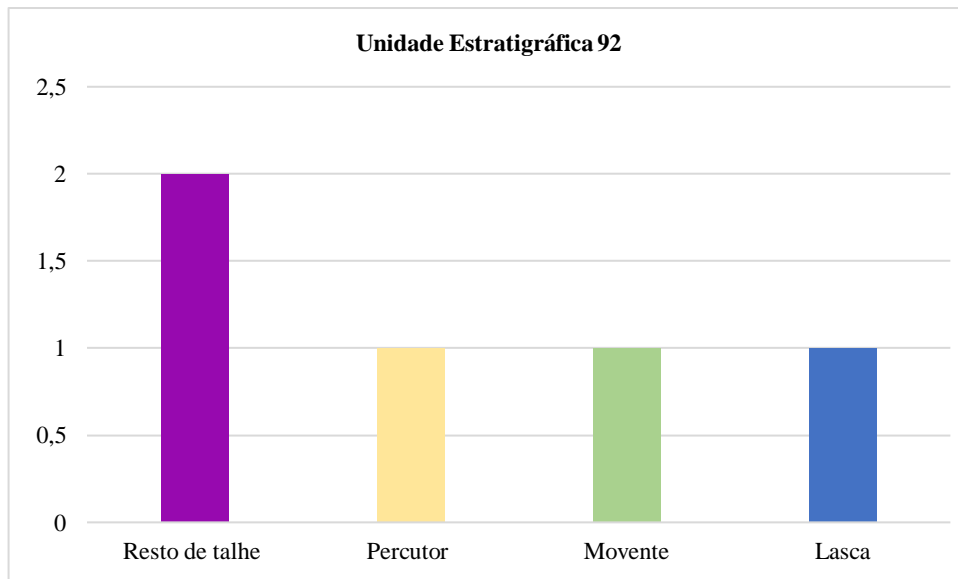

Gráfico 28: Líticos presentes na Unidade Estratigráfica [UE94]

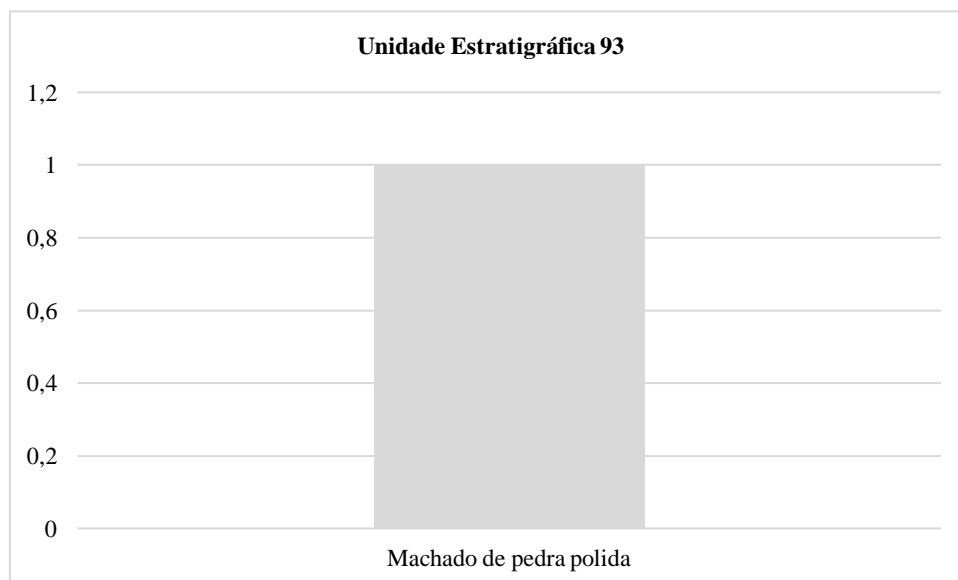

Gráfico 29: Líticos presentes na Unidade Estratigráfica [UE99]

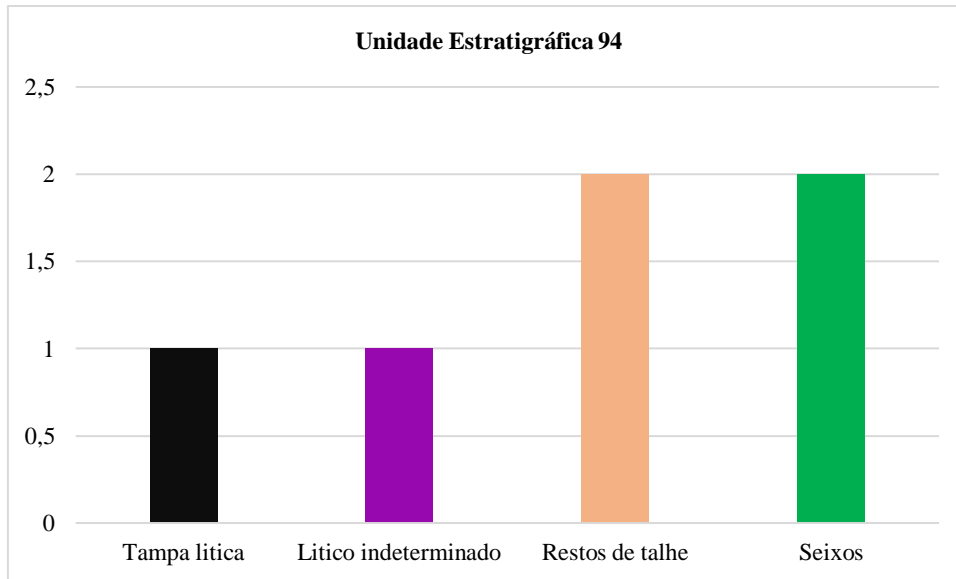

Gráfico 30: Líticos presentes na Unidade Estratigráfica [UE109]

Anexo IV
Cerâmicas – Tipologias

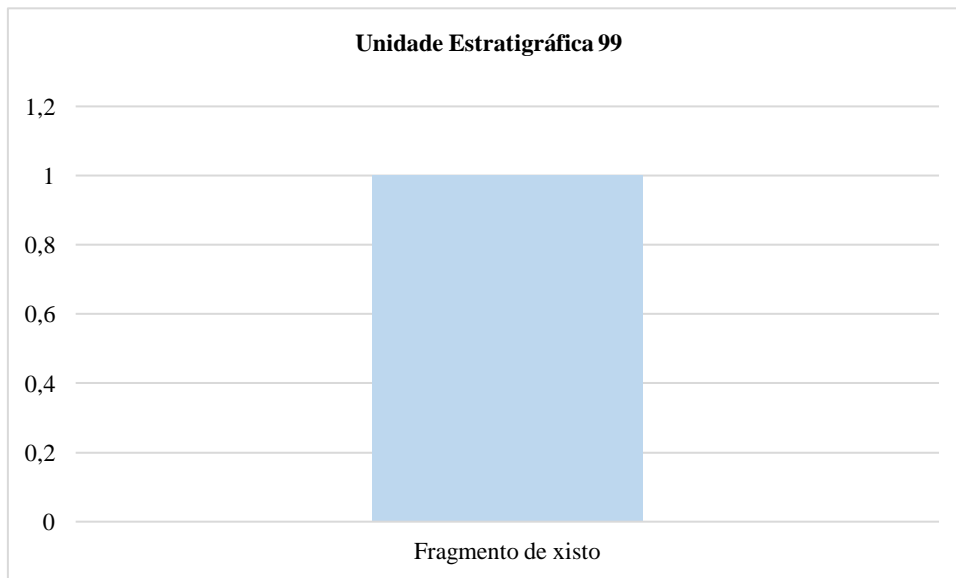

Figura 8: Pratos- **3082:** 1.6c; **1195:**1.1c; **3855:** 1.6d; **3559:** 1.4c; **3948:** 1.5f

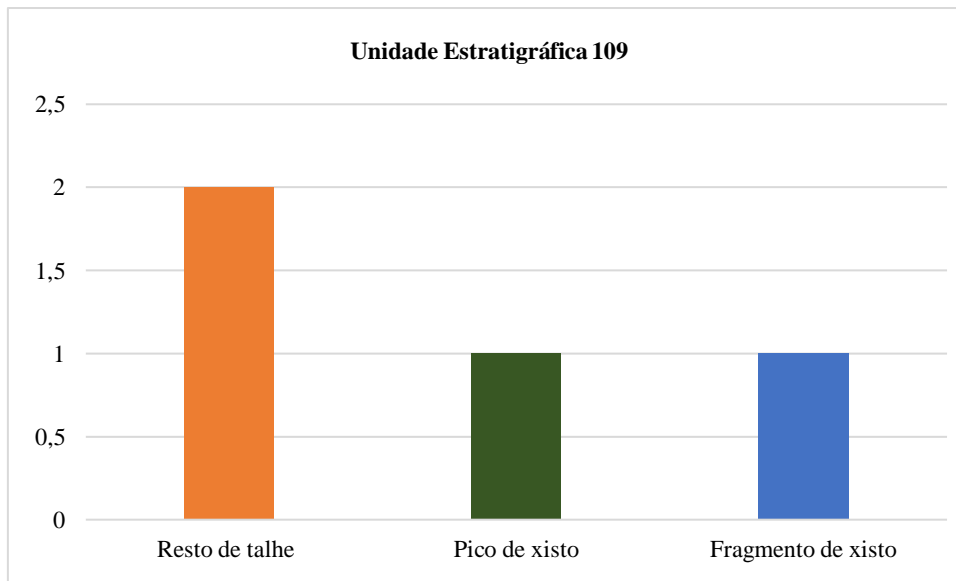

Figura 9: Pratos- **3876:** 1.9; **3921:** 1.1a; **3480:** 1.4a; **3924:** 1.6b

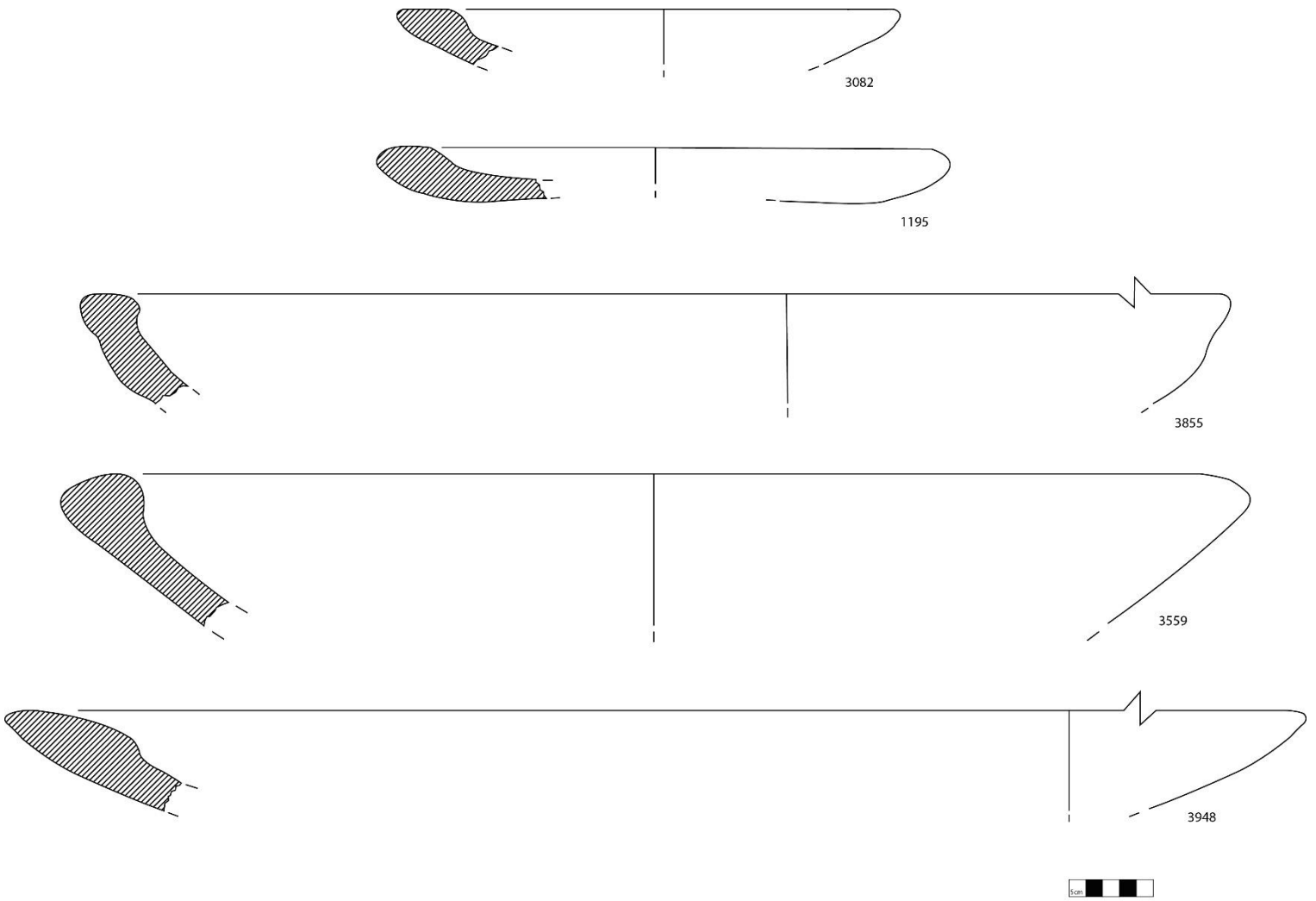

Figura 10: Pratos- 3116: 1.5j 1312: 1.5d; 4438: 1.6d

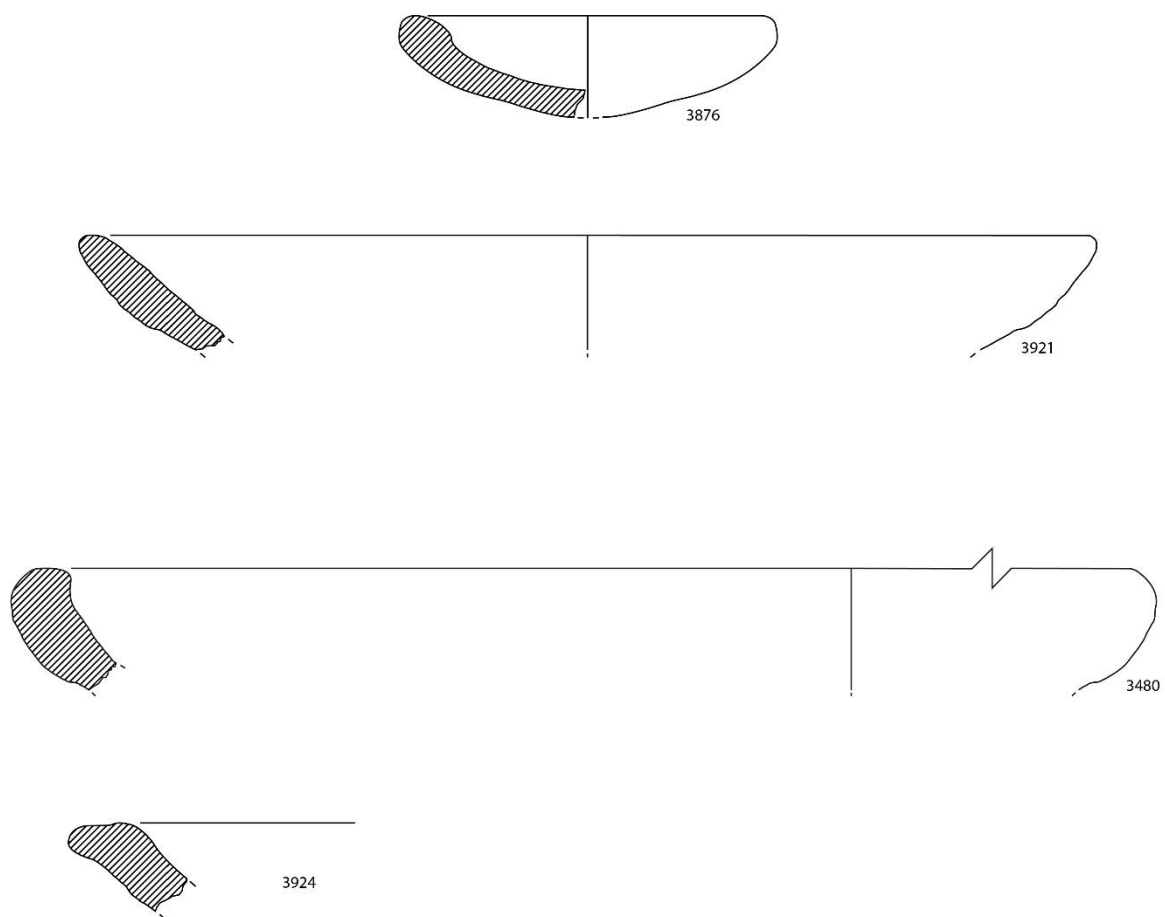

Figura 11: Pratos- **4284:** 1.5e; **4182:** 1.5f; **4427:** 1.7; **3512:** 1.5i; **3464:** 1.5g

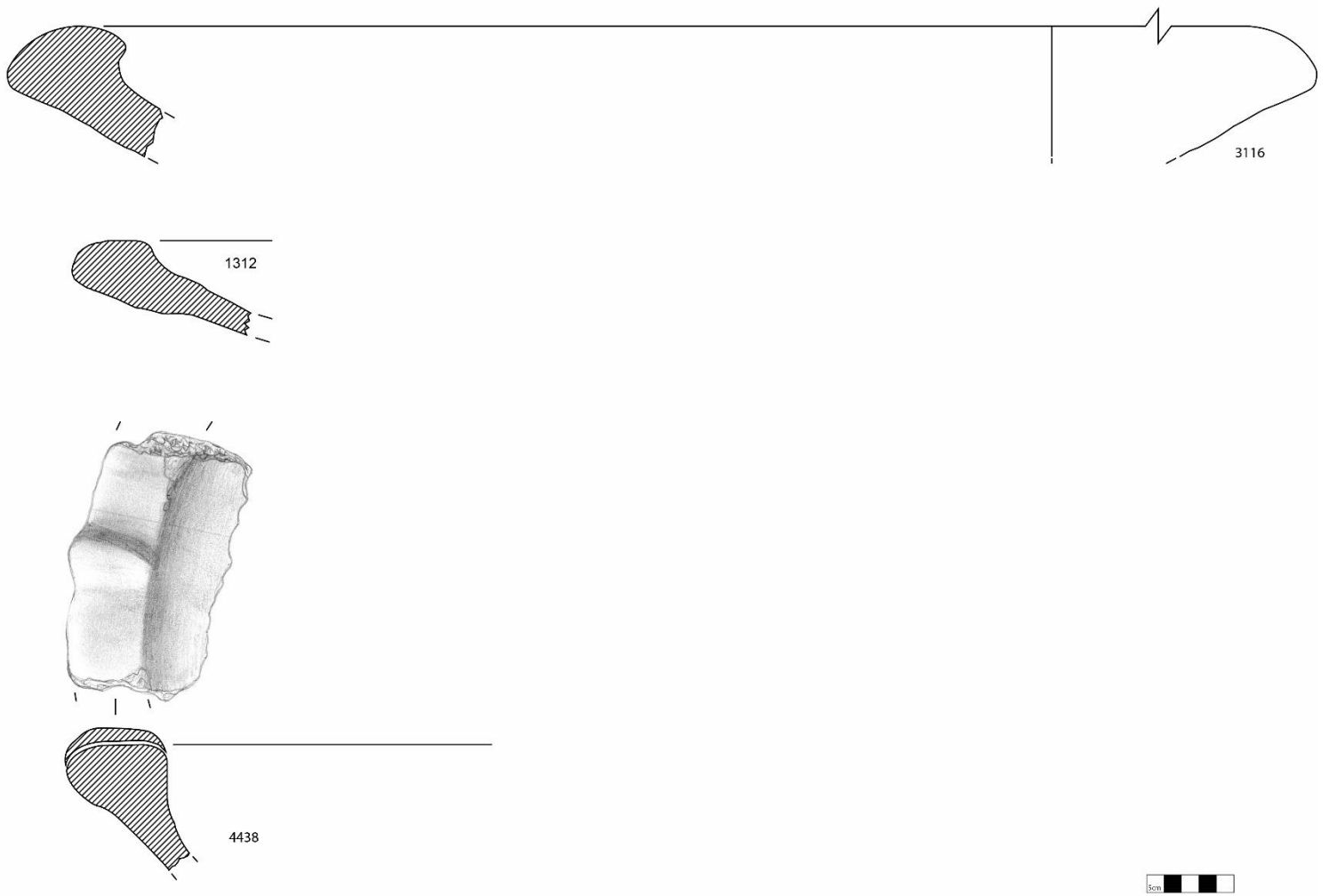

Figura 12: Pratos- **498:** 1.3c; **4418:** 1.5c; **1125:** 1.5b

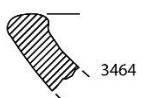
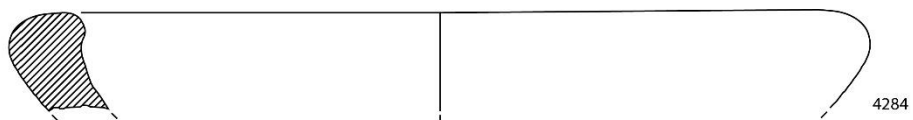

Figura 13: Pratos- 559:1.4b; 4348: 1.6e; 4260: 1.5h; 847: 1.4b

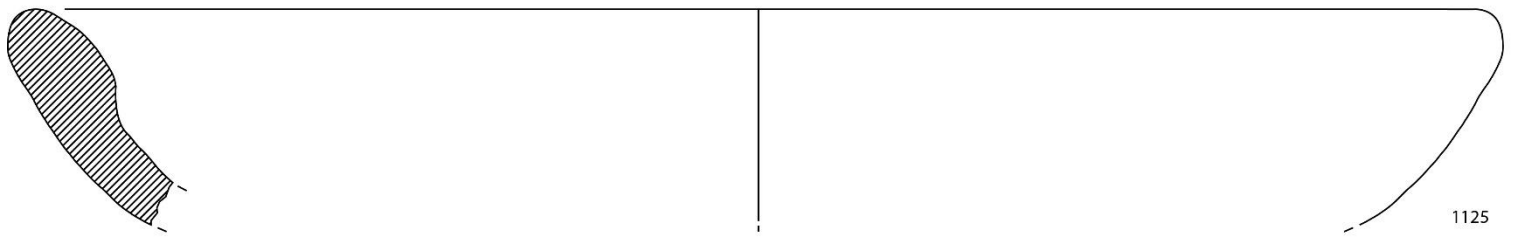
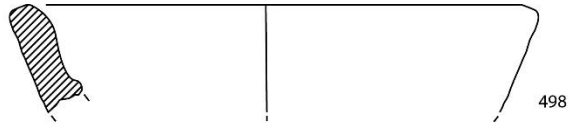

Figura 14: Taças- **416:** 2.7b; **862:** 2.4a; **87b:** 2.11

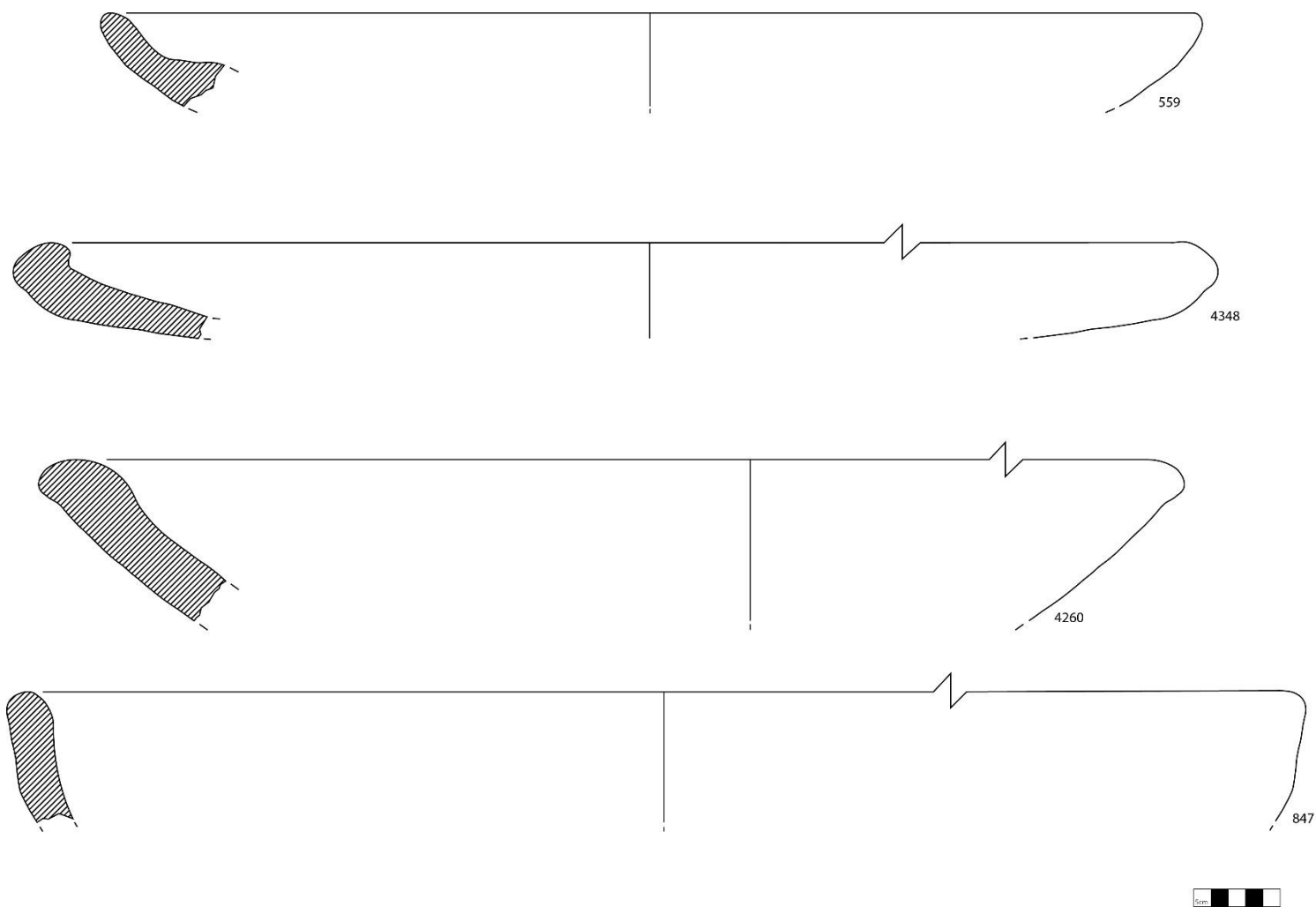

Figura 15: Taças- **3914:** 2.1a; **1186:** 2.4a; **3582:** 2.14; **3385:** 2.4c

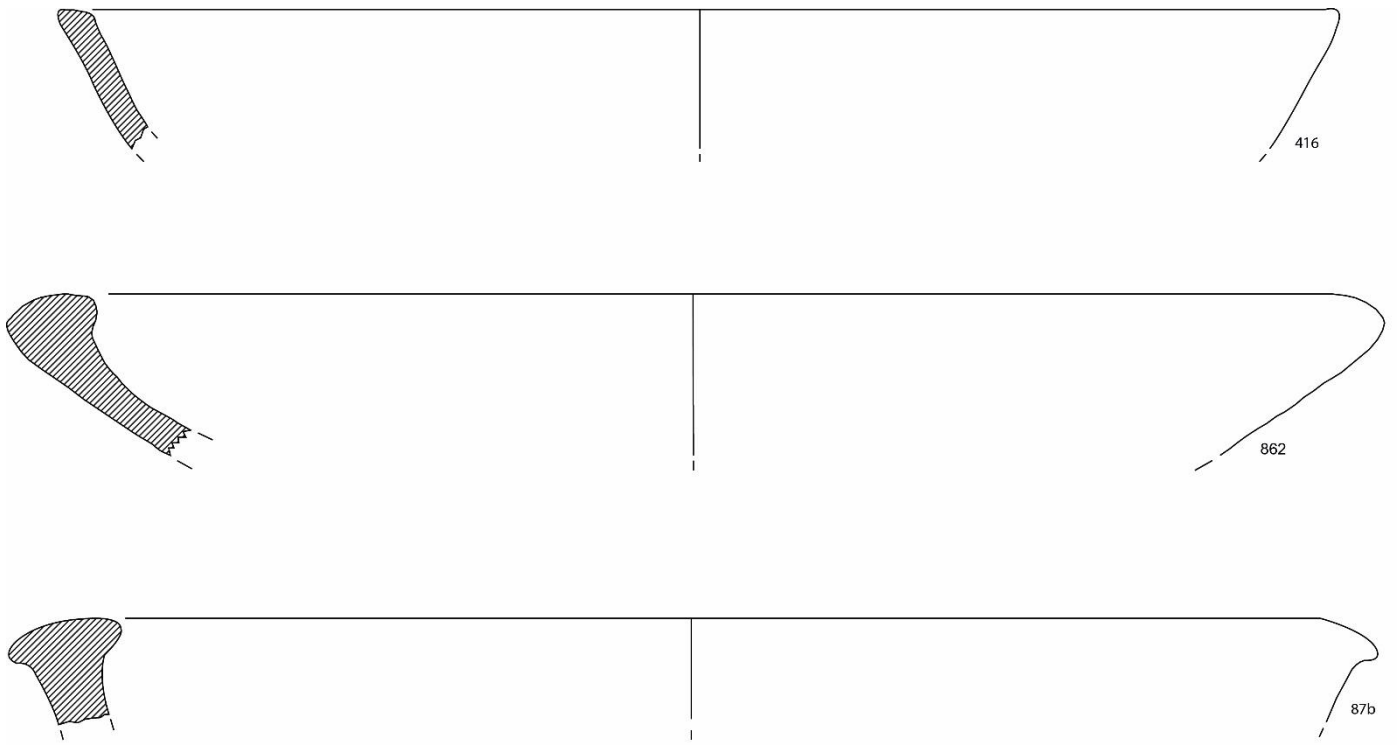

Figura 16: Taças- **2188:** 2.1a ; **2177:** 2.3b; **1127:** 2.4a;

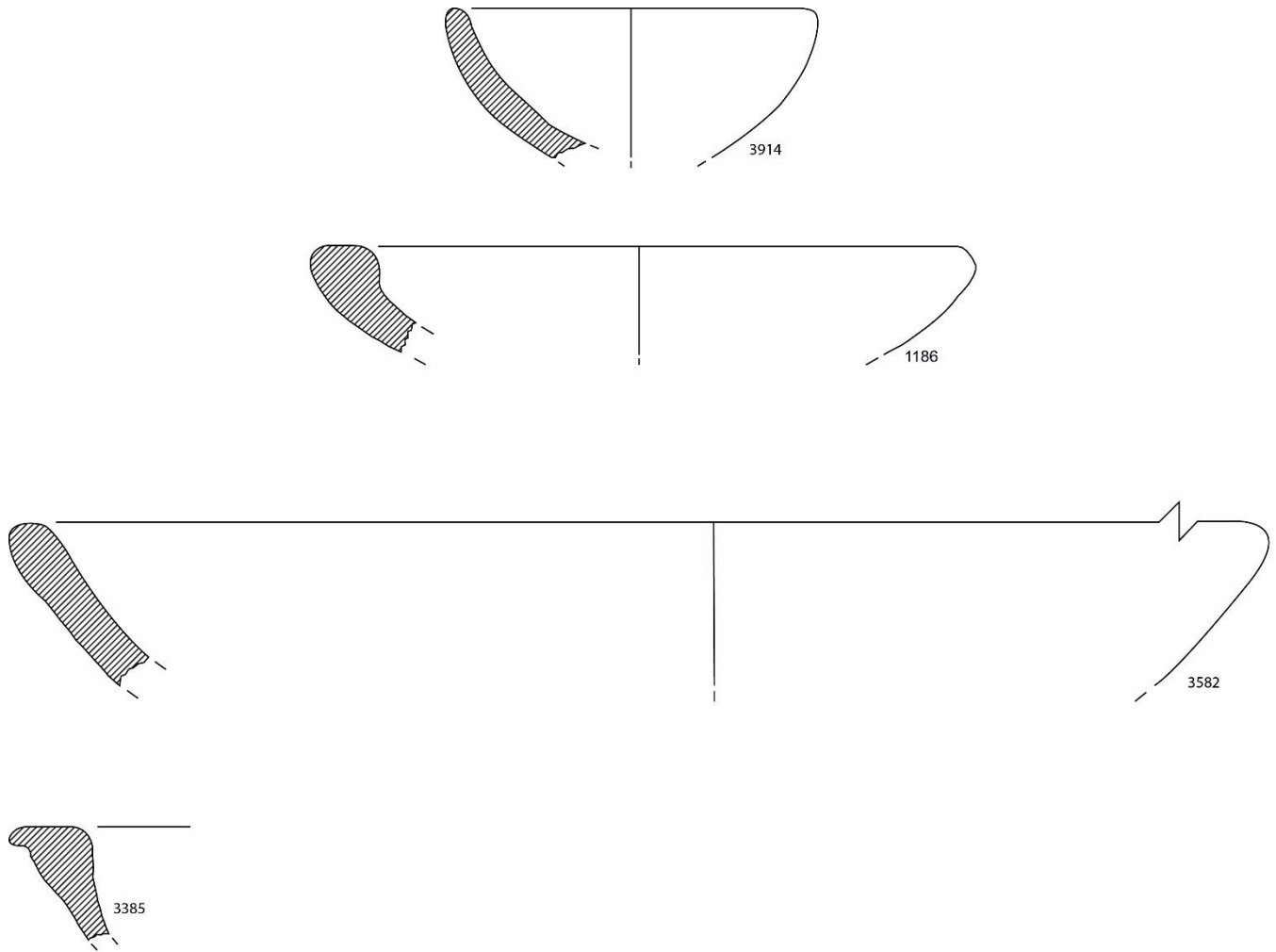

Figura 17: Taças-539: 2.3b; 3756: 2.12;86b:2.10

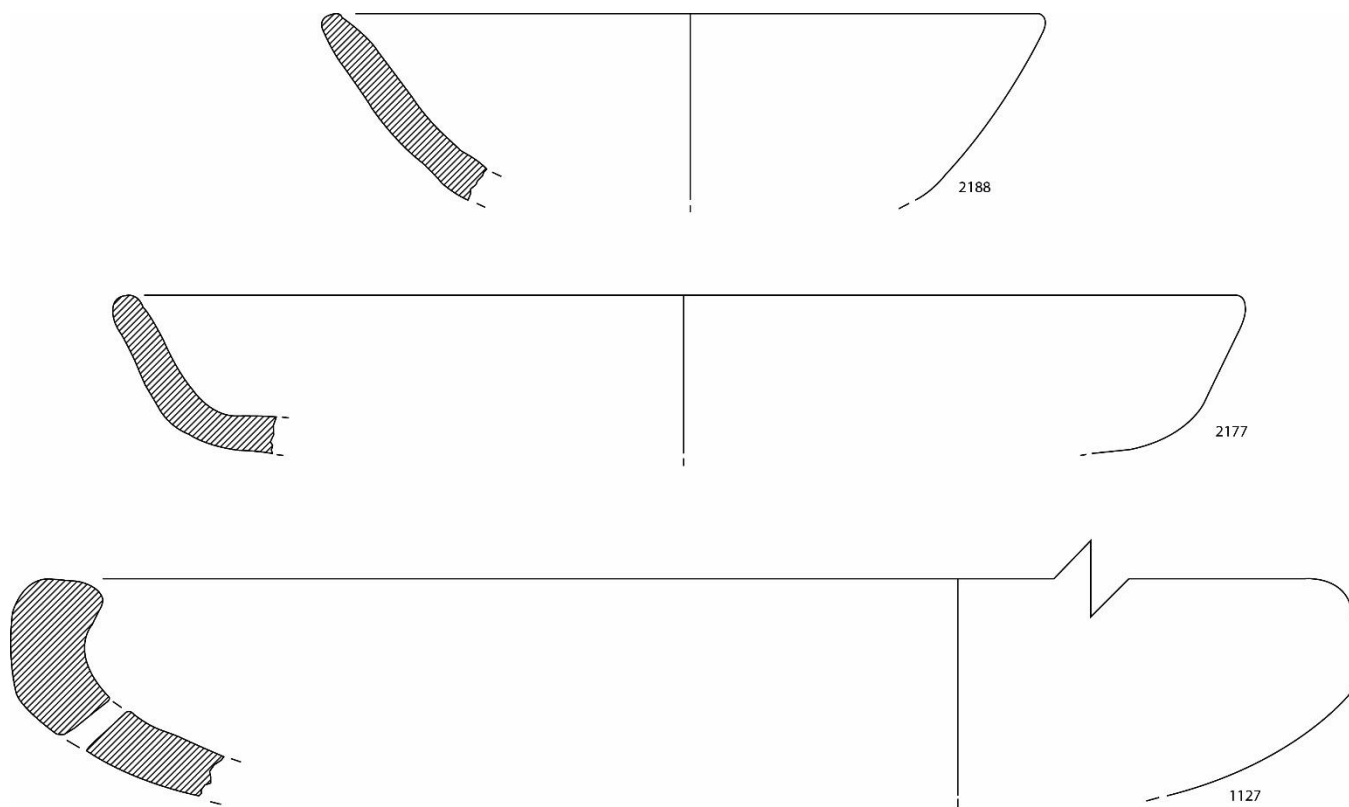

Figura 18: Taças- **1436:** 2.1a; **1303:** 2.2b; **1060:** 2.2a; **771:** 2.1b

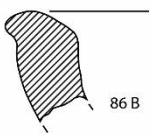
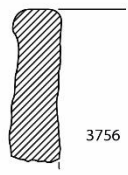

Figura 19: Taças- 4343:2.3a; 3289: 2.5b; 3241: 2.13

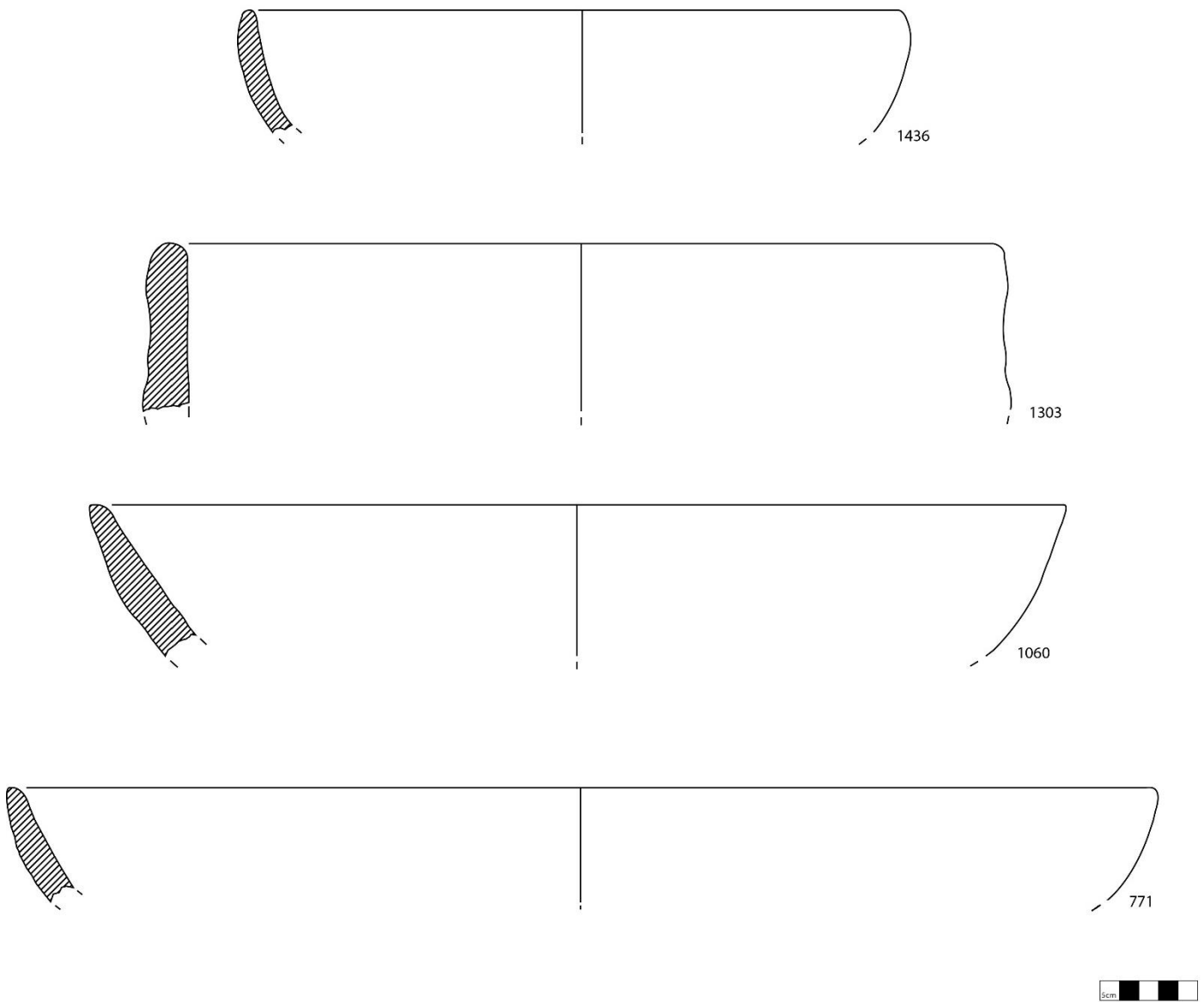

Figura 20: Taças- **251:** 2.5a com decoração; **3610:** 2.10; **905:** 2.6; **4264:** 2.15

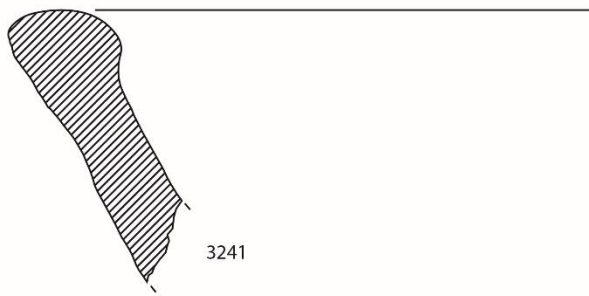
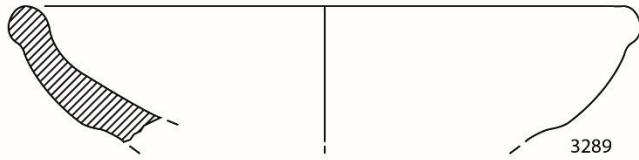
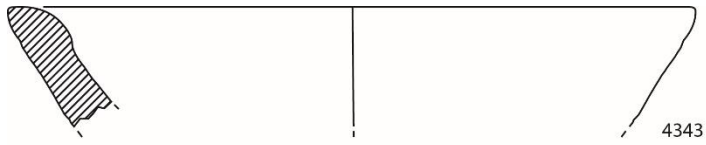

4772

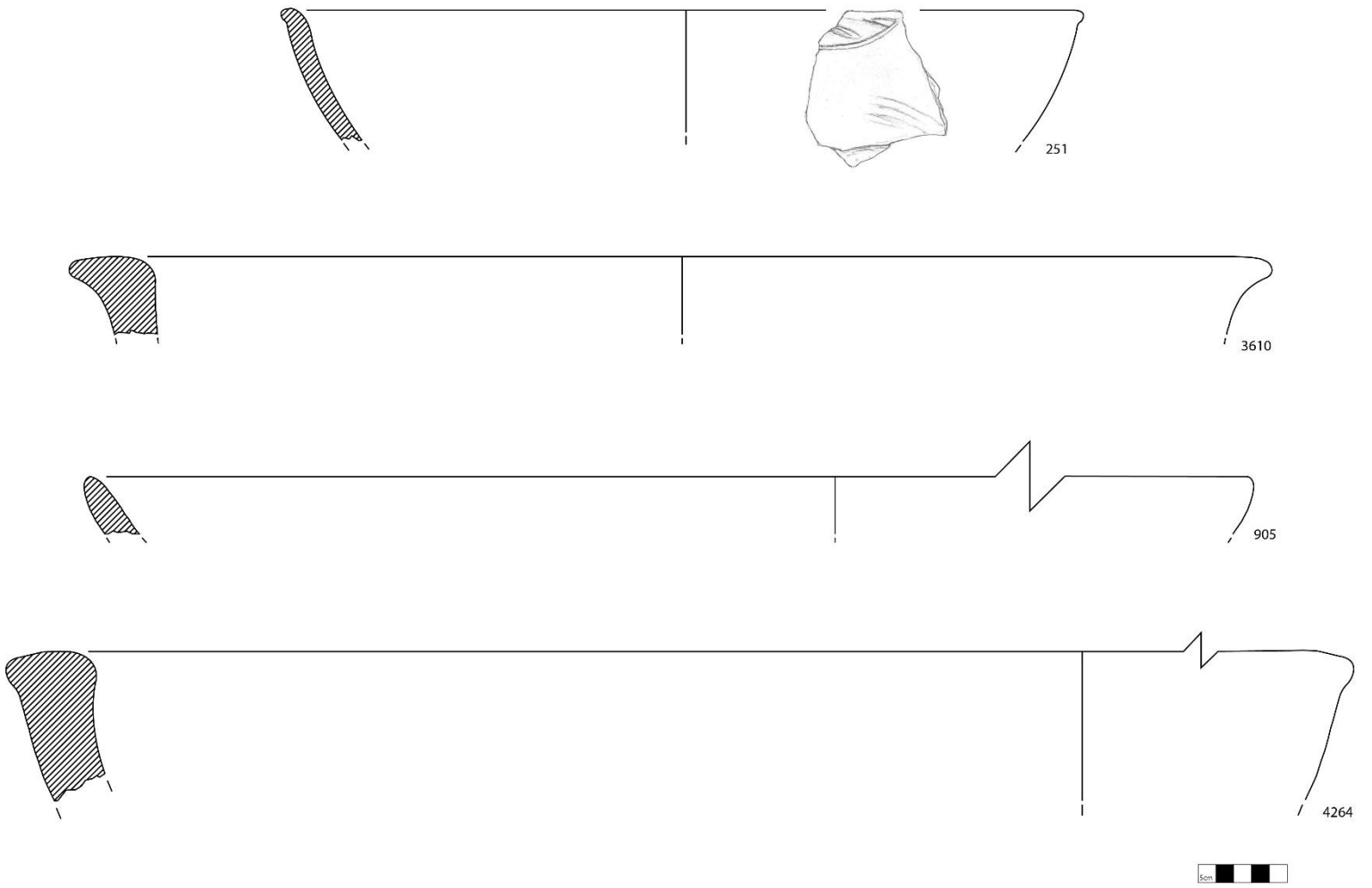
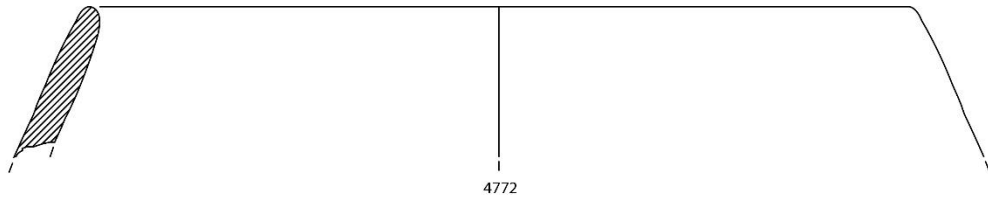
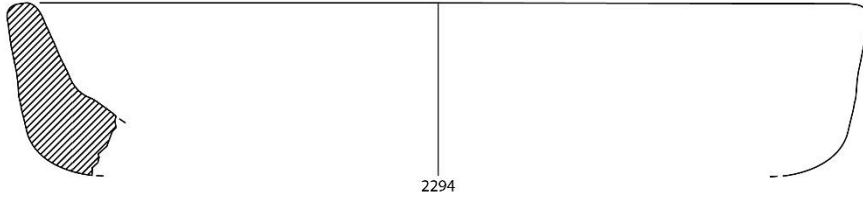

2294



4463

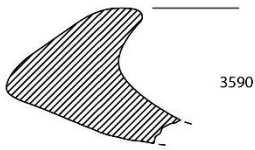

3590



Figura 21: Taças carenadas – 4772: 3.1a; 2294: 3.3c; 4463: 3.1a; 3590: 3.3a



Figura 22: Tigelas- 995: 4.2a; 249: 4.2f; 4472: 4.2h; 765: 4.2c; 2290: 4.2d



Figura 23: Tigelas- 132: 4.2d; 2002: 4.2f; 2173: 4.2c

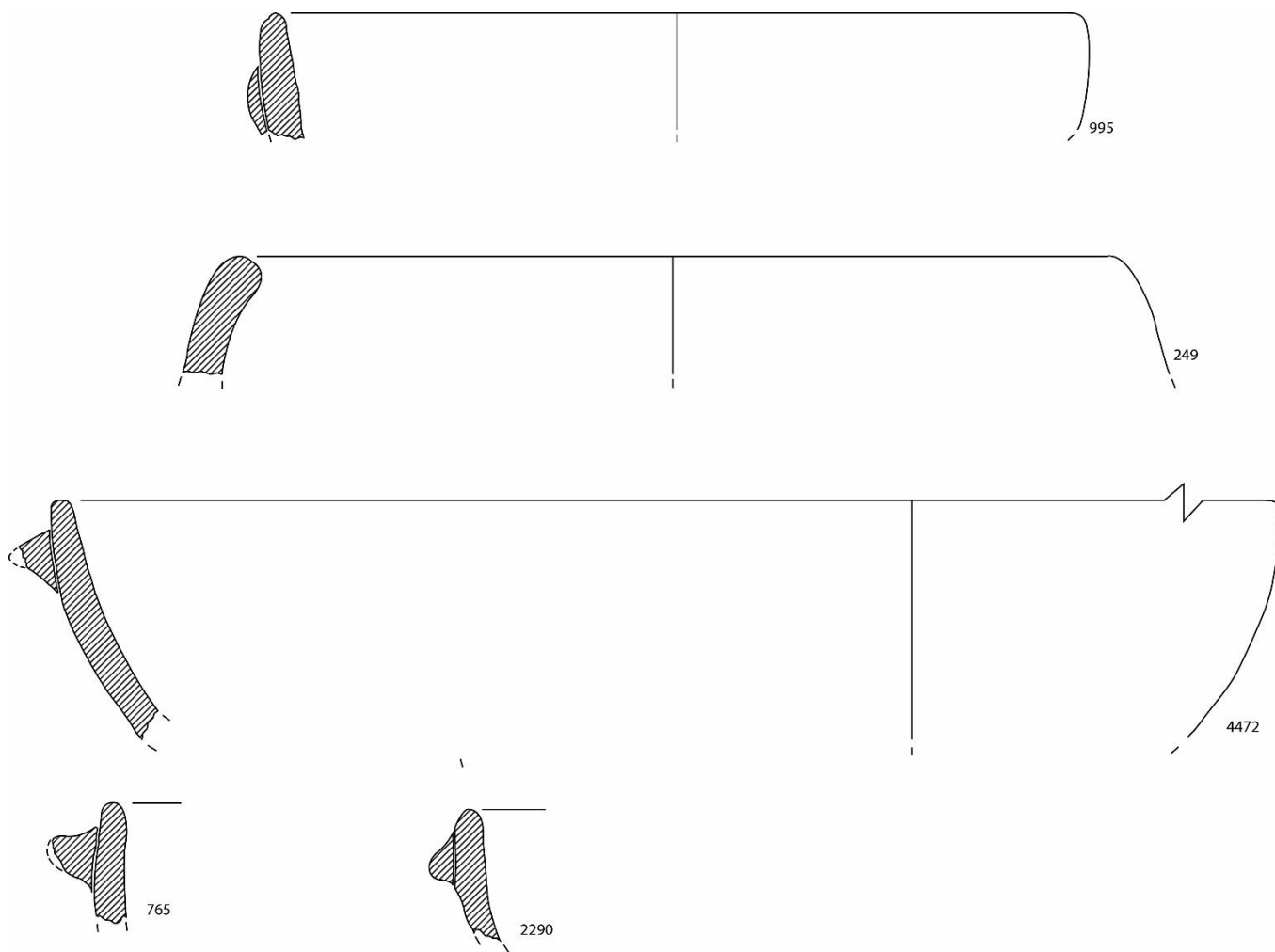

Figura 24: Tigelas- 1419:4.5; 3977: 4.2g; 4115: 4.3a



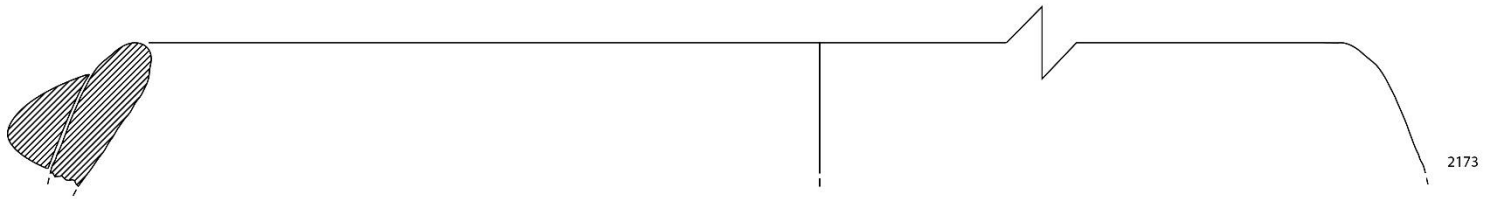
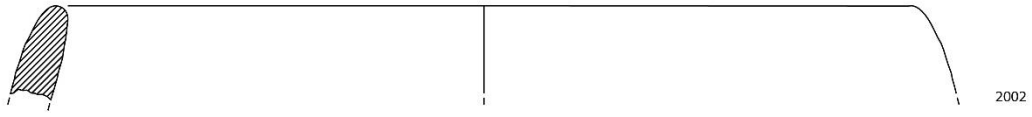

Figura 25: Esféricos- 4413: 5.3; 2140: 5.2; 4150: 5.1b com decoração simbólica ;3367: 5.1; 2327: 5.1b

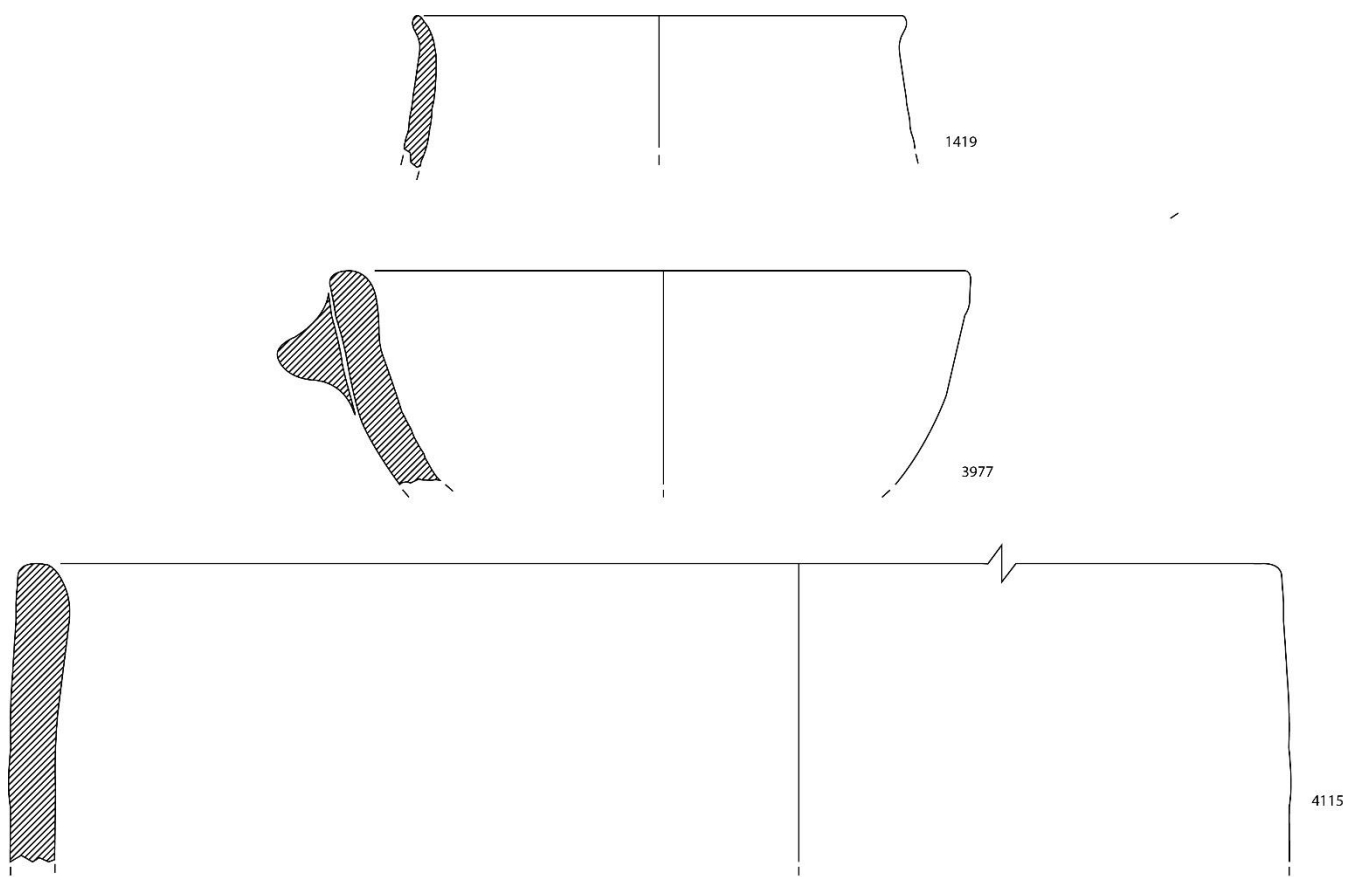

Figura 26: Globulares- **3902/3905:** 6.5 com decoração simbólica; **819:** 6.1b**4466:** 6.1b; **2344:** 6.1g

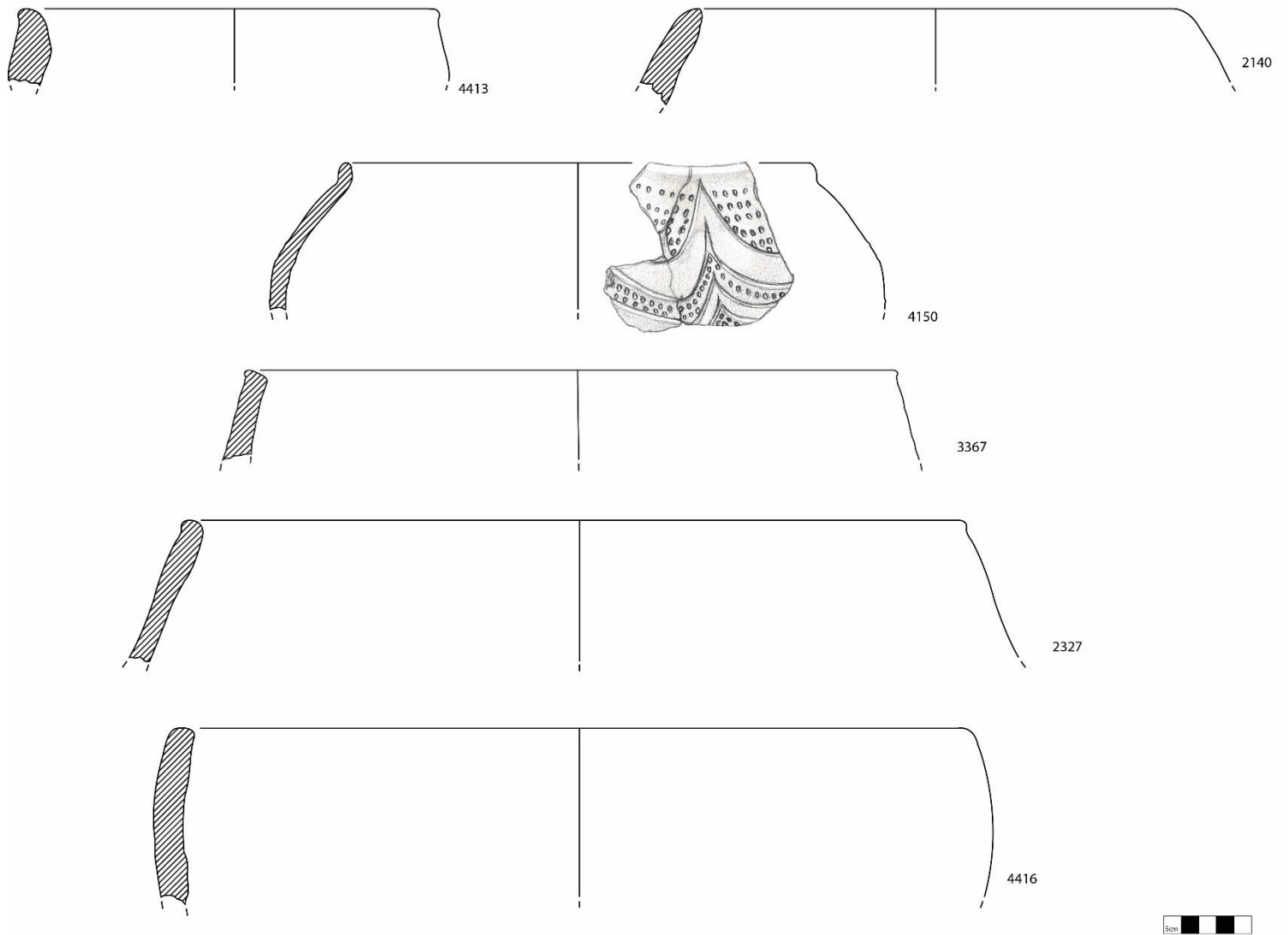

Figura 27: Globulares- 645: 6.1c; 951: 6.3a; 4845: 6.3c com decoração em caneluras

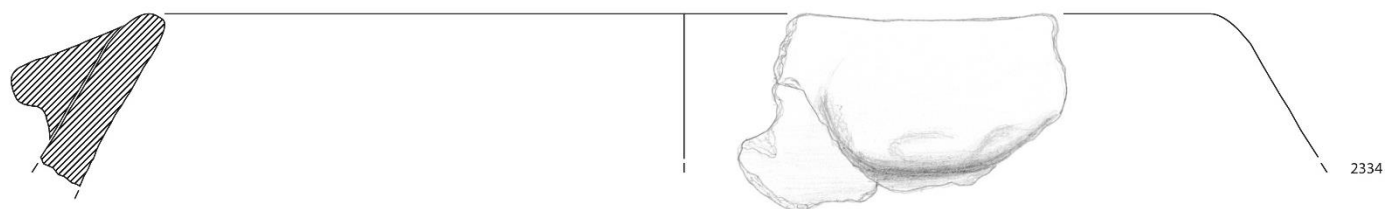
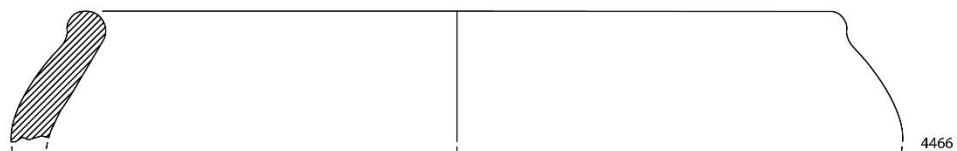
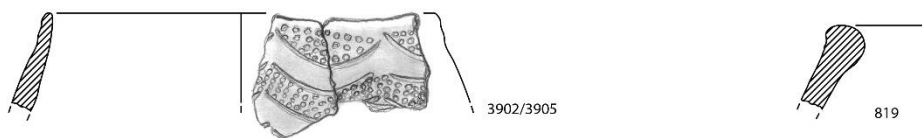

Figura 28: Globulares- **212:** 6.1b; **3494:** 6.1d; **3736:** 6.7; **2150:**6.1f

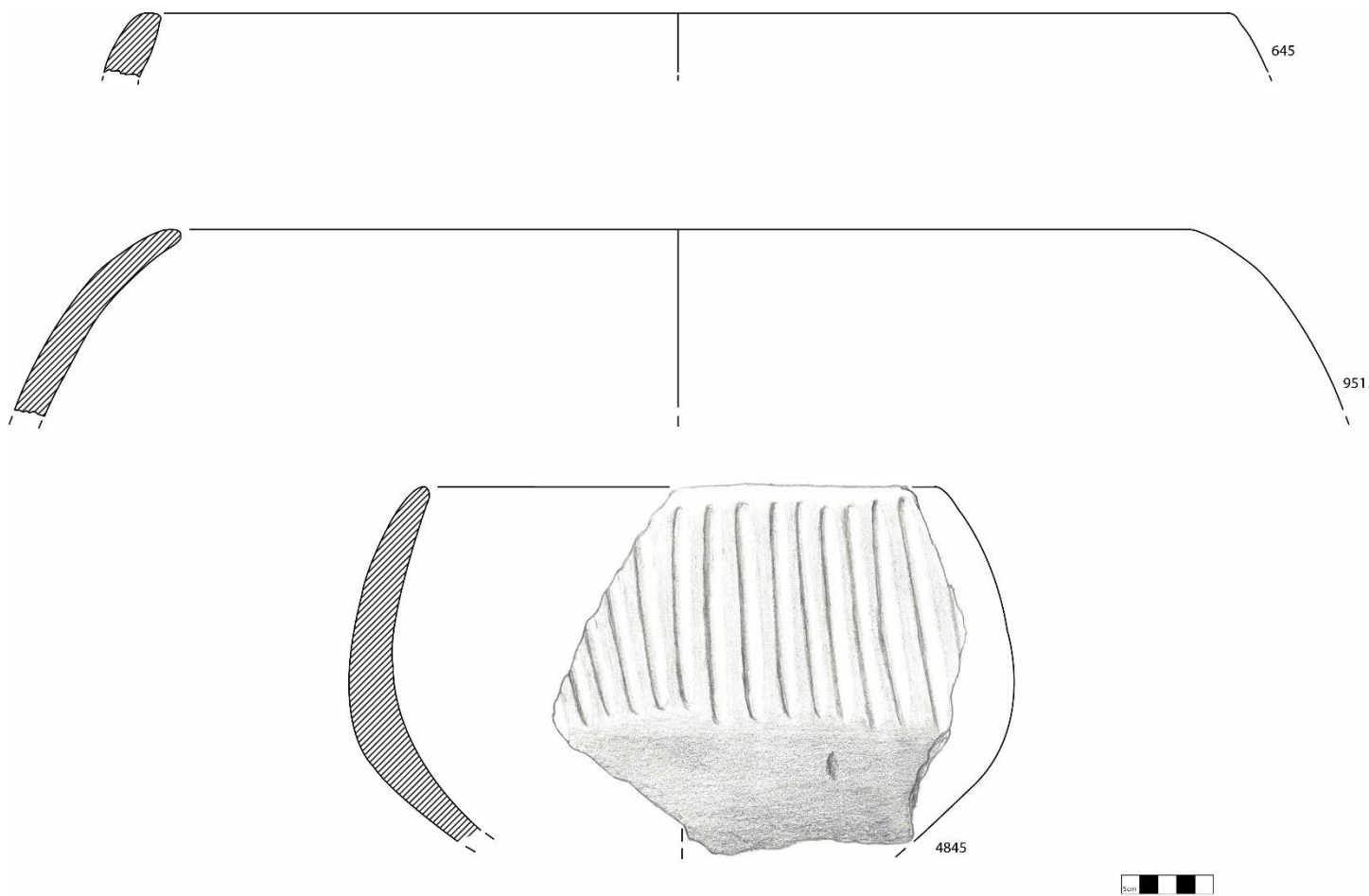

4449

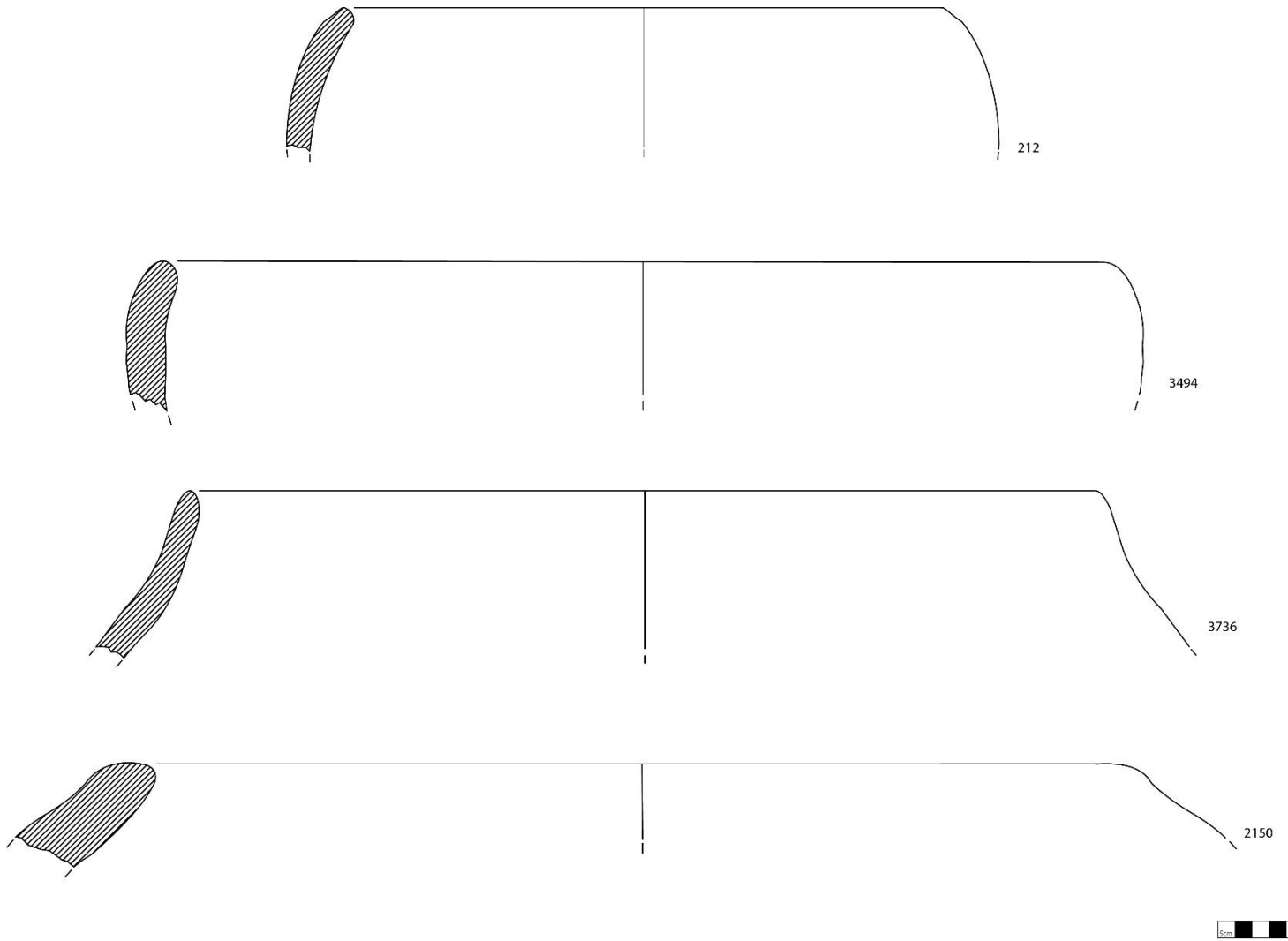
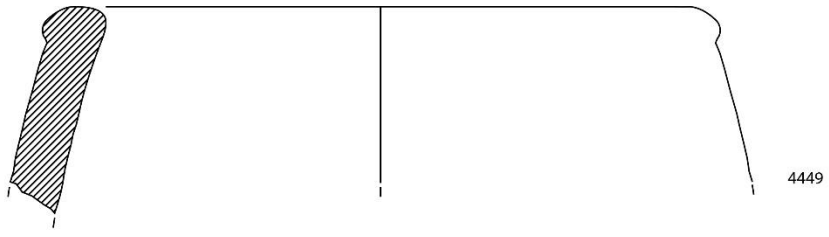
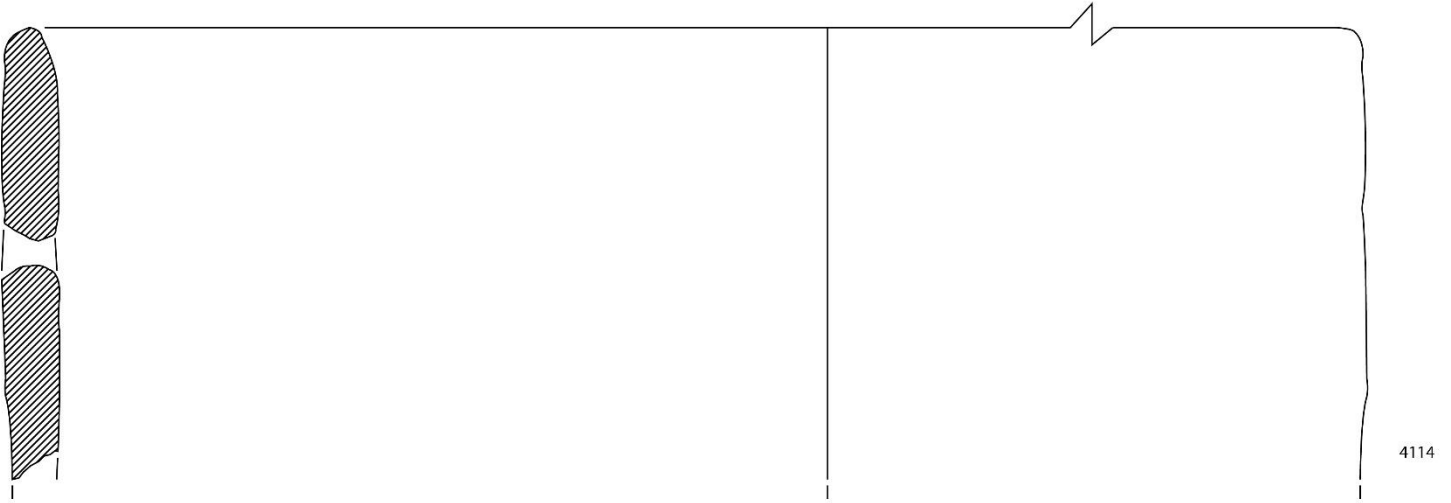

4114



Figura 29: Recipientes tipo saco: 4449: 7.4; 4114: 7.1a



Figura 30: Recipientes tipo saco: 345: 7.4



Figura 31: Taça de carena média: **147:** 9.a ; **2115:** 9.c

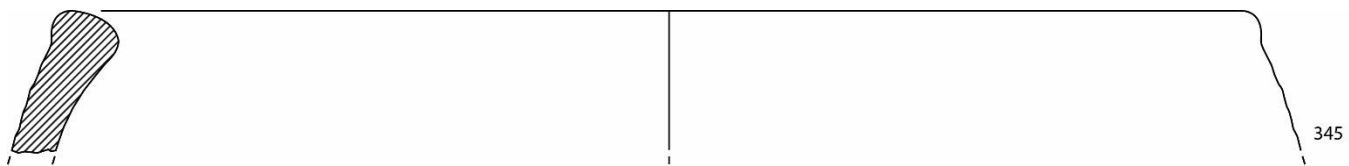

Figura 32: Copos- **1124:** 10.8; **4175:** 10.5; **3854:** 10.3; **3177:** 10.7; **4773:** 10.4; **2014:** 10.5

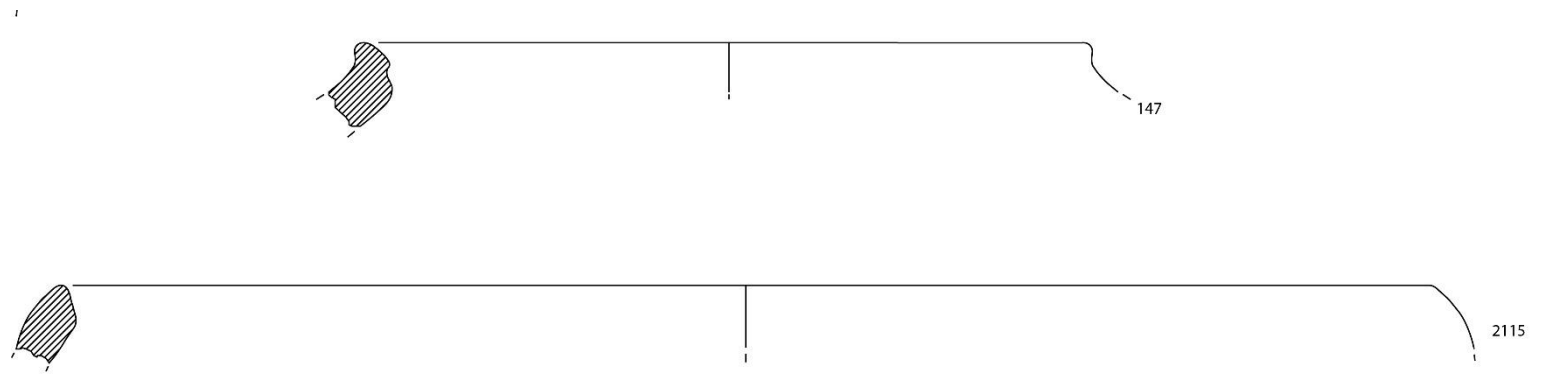

Figura 33: Mini vasos- **1200:** 13.13b; **263:** 13.13c; **4767:** 13.13i; **2010:** 13.13g; **3539:** 13.13f

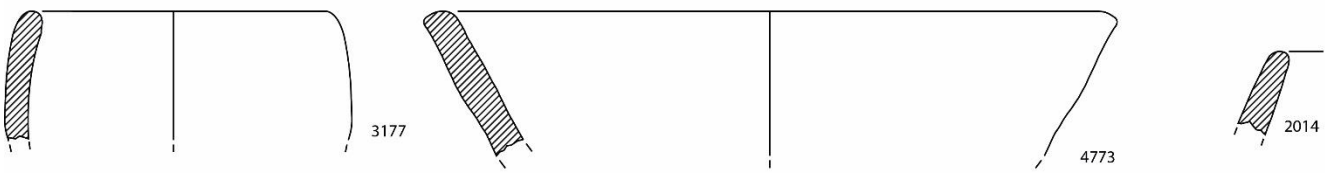
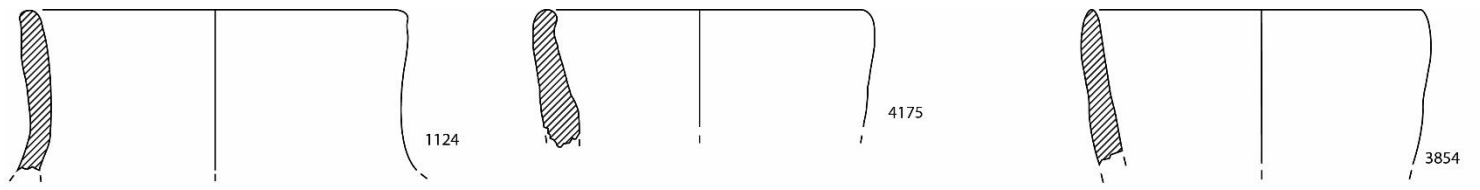

Figura 34: Acampanados- **918:** 15.1a

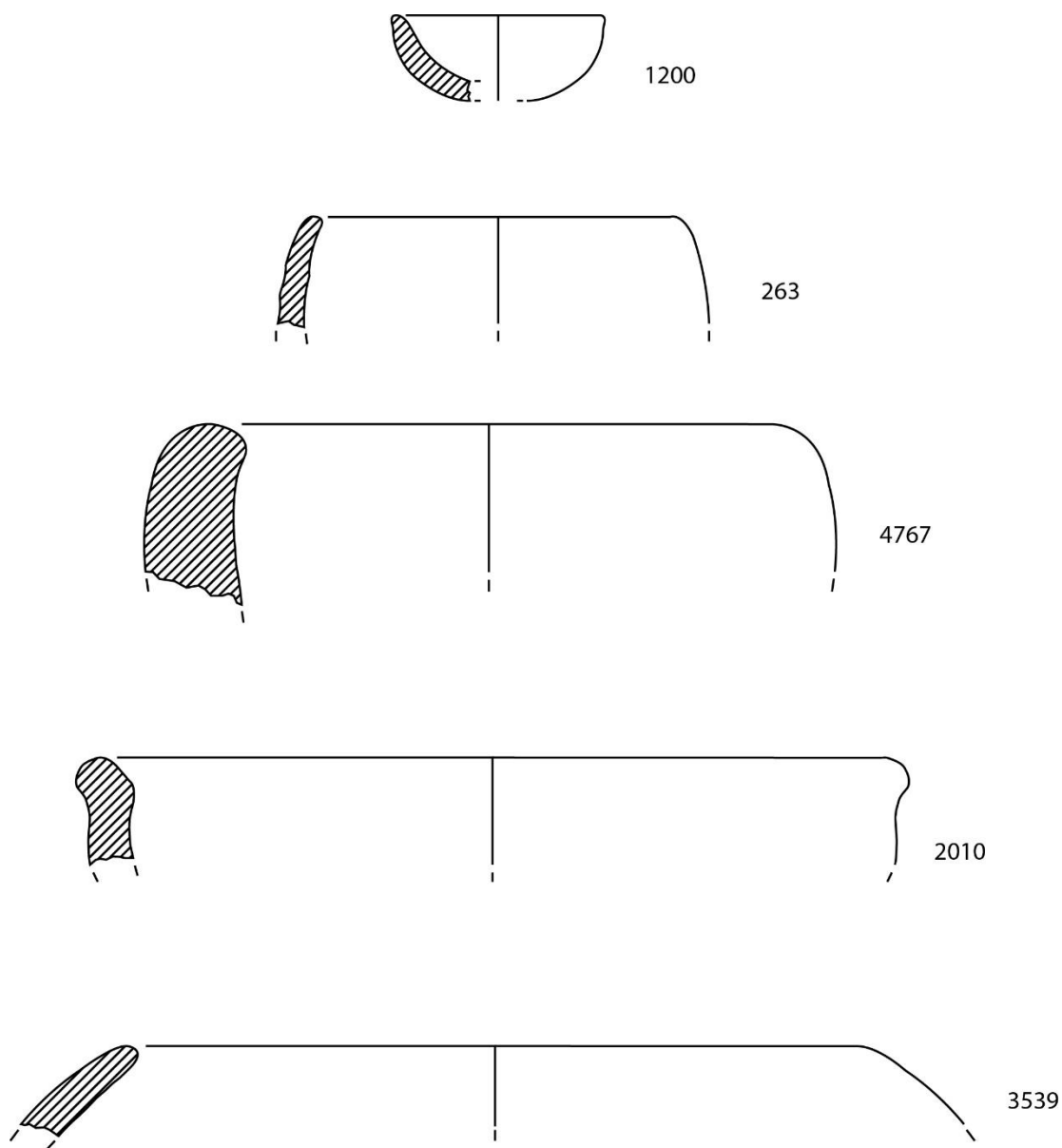

Figura 35: Caixa- 1263: 19

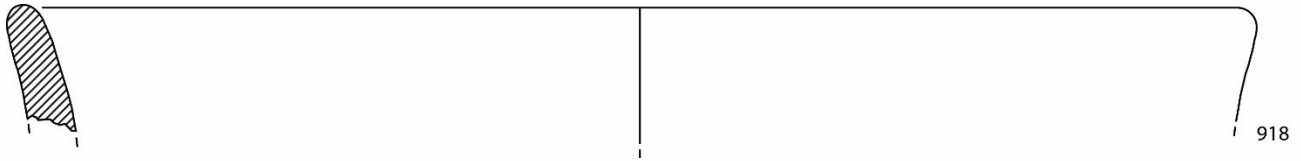

Figura 36: Vaso de soporte



Figura 37: Vários- 3146: Mamilo; 4341: Colher

Anexo V
Componentes de tear

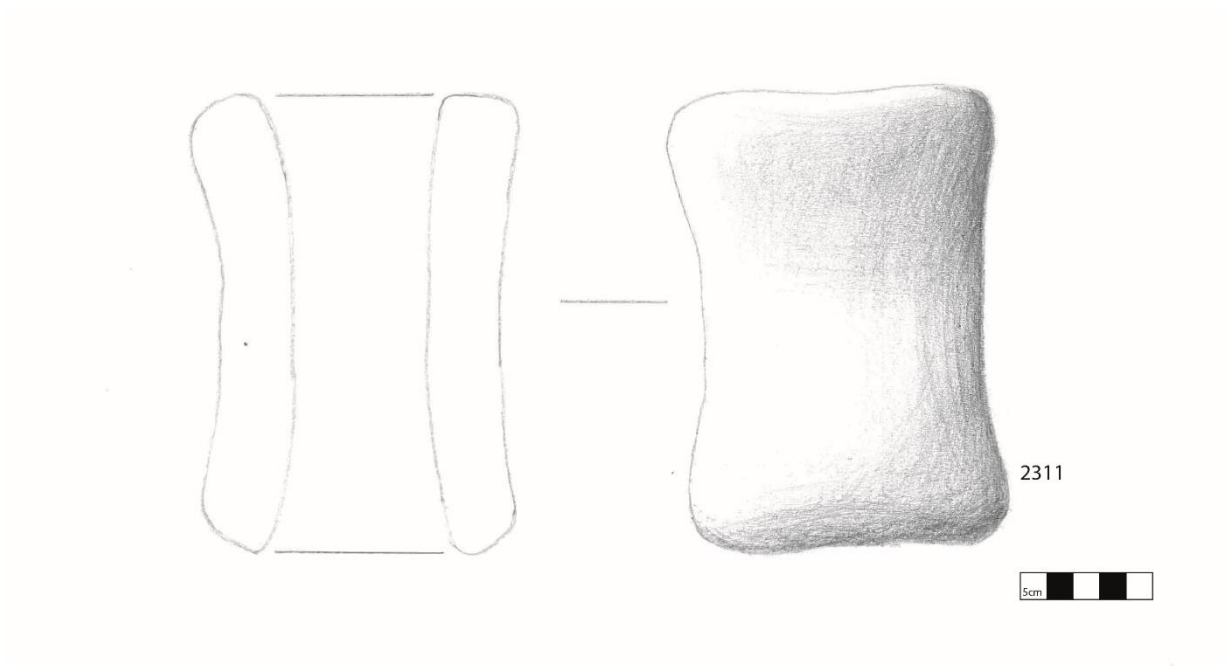

Figura 38: Componentes de tear- **1129:** Placa de tear; **3105:** Crescente; **2312:** Crescente

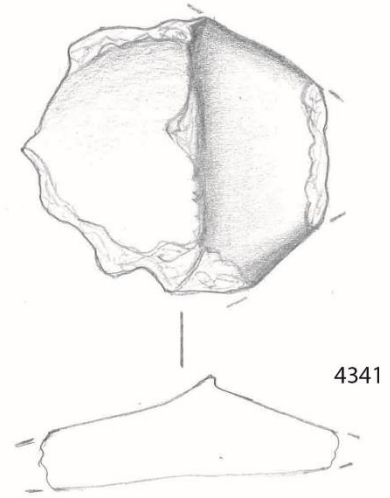
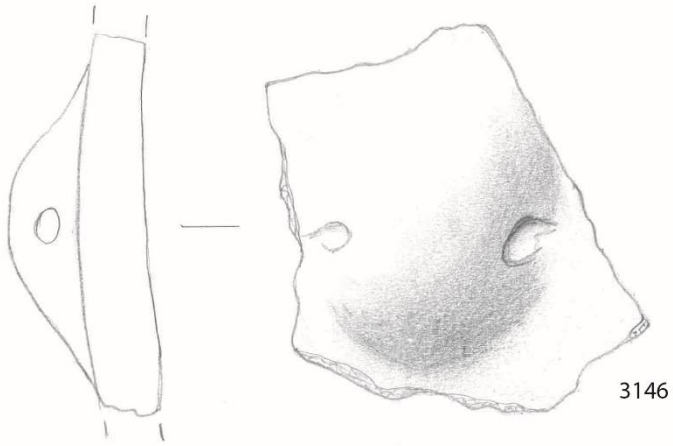
Anexo VI
Líticos - Fotografías



Figura 39: Percutor em matéria quartzítica

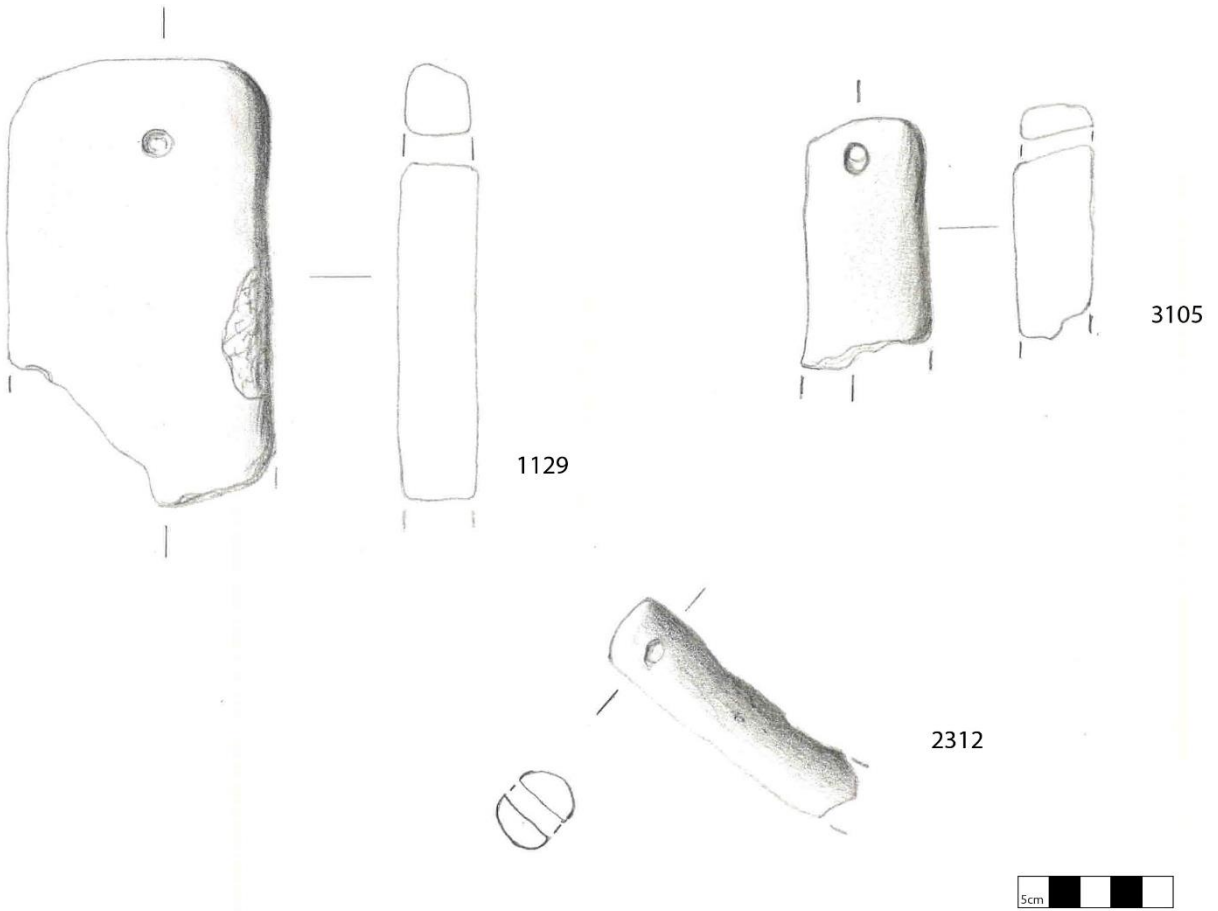

Figura 40: Bigorna de xisto



Figura 41: Machado de pedra polida



Figura 42 Ponta de seta em xisto jaspoide



Figura 43: Ponta de seta em xisto jaspoide



Figura 44: Enxó



Figura 45: Lâmina em material silicioso



Figura 46: Lasca de material quartzítico



Figura 47: Resto de talhe de xisto jaspóide



Figura 48: Disco em xisto



Figura 49: Lasca de quartzo

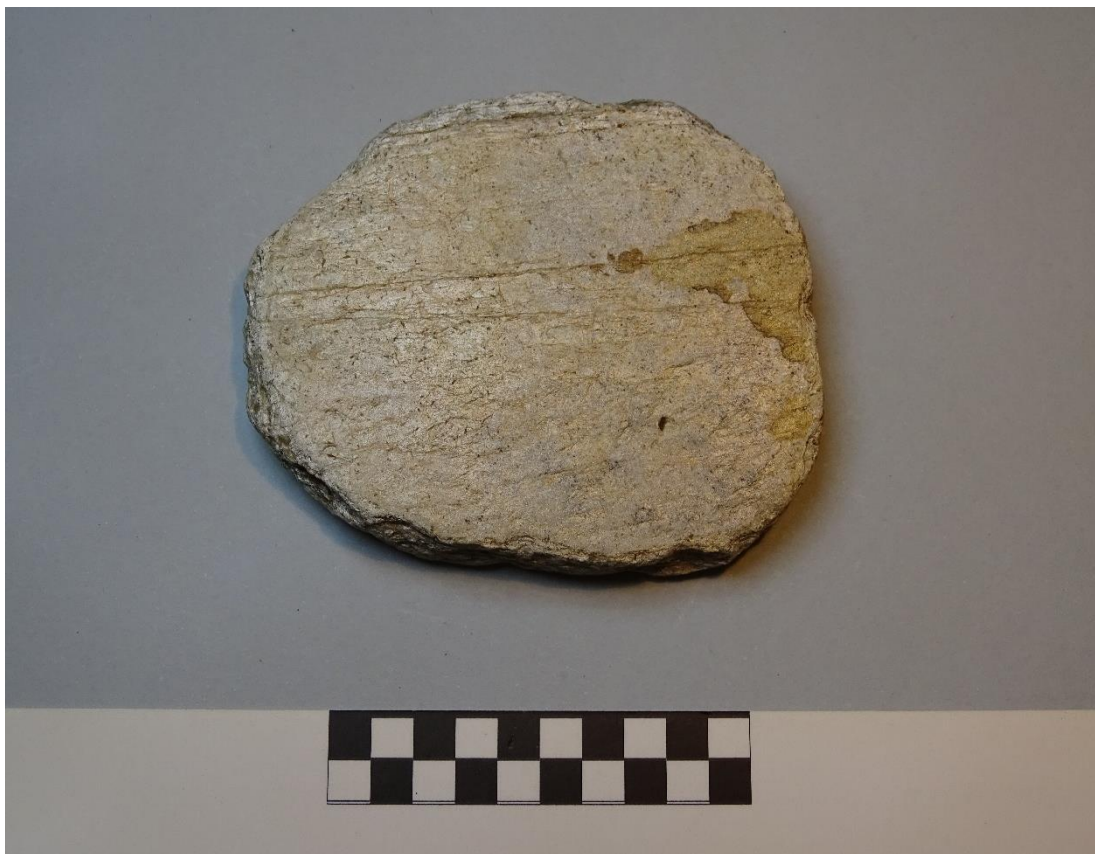

Figura 50 Pico de xisto



Figura 51: Pico de xisto



Figura 52: Fragmento de ponta de seta em xisto jaspoide



Figura 53: Fragmento de machado de pedra polida

Anexo VI
Cerâmicas - Fotografias



Figura 54 Fotografia do fragmento 4150



Figura 55: Fotografia do fragmento 4845



Figura 56: Fotografia do fragmento 251



Figura 57: Fotografia do fragmento 4419



Figura 58: Fotografia do Vaso de Suporte