

**Third European Conference
on electrochemical
methods applied to the
conservation of artworks**

**Valencia
28th March
2017**

Proceedings

Editors:

María Teresa Doménech Carbó & Antonio Doménech Carbó

EDITORIAL: UNIVERSITAT POLITÈCNICA DE VALÈNCIA

**Proceedings of the Third European
Conference on electrochemical methods
applied to the conservation of artworks.
New insights into the technical examination
and conservation of metallic heritage artefacts**

Valencia, 28th March, 2017

Editors

María Teresa Doménech Carbó

Antonio Doménech Carbó

**EDITORIAL
UNIVERSITAT POLITÈCNICA DE VALÈNCIA**

Congresos UPV
Third European Conference on electrochemical techniques applied to the conservation of artworks

Scientific Editors
María Teresa Doménech Carbó
Antonio Doménech Carbó

© of the text: the authors

© 2018 Editorial Universitat Politècnica de València
www.lalibreria.upv.es / Ref.: 6461_01_01_01

ISBN: 978-84-9048-698-6

Any unauthorized copying, distribution, marketing, editing, and in general any other exploitation, for whatever reason, of this piece of work or any part thereof, is strictly prohibited without the authors' expressed and written permission.

COMMITTEES INVOLVED IN THE ORGANIZATION OF THE THIRD EUROPEAN CONFERENCE ON ELECTROCHEMICAL TECHNIQUES APPLIED TO THE CONSERVATION OF ARTWORKS

Comité Científico/Scientific Committee:

Doménech Carbó, Antonio, Universitat de València, España
Doménech Carbó, María Teresa, Universitat Politècnica de València, España
Sofia Capelo, Universidad de Evora, Evora, Portugal
del Hoyo Melendez, Julio, National Museum of Krakow, Polonia
Martínez Bazán, María Luisa, Universitat Politècnica de València, España
Osete Cortina, Laura, Universitat Politècnica de València, España
Pasés Oviedo, Trinidad, Museo de Prehistoria de Valencia, España
Scholz, Fritz, University of Greifswald, Alemania
Vivancos Ramón, María Victoria, Universitat Politècnica de València, España

Comité Organizador/Organization Committee:

Capelo, Sofia, Universidad de Evora, Evora, Portugal
Del Hoyo Melendez, Julio, National Museum of Krakow, Polonia
Doménech Carbó, Antonio, Universitat de València, España
Doménech Carbó, María Teresa, Universitat Politècnica de València, España
Pasés Oviedo, Trinidad, Museo de Prehistoria de Valencia, España
Scholz, Fritz, University of Grefswald, Greifswald, Alemania

FOREWORDS

This book is issued at the occasion of the Third European Conference on electrochemical methods applied to the conservation of artworks, held in Valencia on 28th March 2017. This Conference has been hosted by the *Instituto Universitario de Restauración del Patrimonio* of the *Universitat Politècnica de València* and has been organized under the auspices of the *Ministerio de Economía y Competitividad* (MINECO), the *Universitat Politècnica de València* and the *Universitat de València*.

This Conference takes part of the dissemination of the results plan established in projects CTQ2014-53736-C3-1-P and CTQ2014-53736-C3-2-P supported by MINECO and co-supported with ERDEF funds, which are inscribed in the *Programa estatal de fomento de la investigación científica y técnica de excelencia, subprograma estatal de generación del conocimiento* of MINECO.

The Conference has been organized as an exceptional updating of the advances carried out in the last years in the application of electrochemical techniques in the technical examination and conservation of metallic heritage artefacts. The Conference had a complete program that included four Invited Key Lectures devoted to the contribution of the electrochemical techniques to solve the specific problems of the electrochemical analysis of metallic heritage artefacts, three Invited Key Lectures focused on other analytical technique, and seven Invited Key Lectures centred in presenting advances in conservation treatment of this valuable kind of cultural heritage. The program was completed with a poster session where young researchers can present the results of their research.

We would like to thank the members of the Organization Committee for their constant work in the hard task needed for a successful meeting. The Scientific Committee for valuable advice that resulted in the production of an excellent program and to all sponsoring institutions for their support without which this Conference would not have been possible.

The Editors:

María Teresa Doménech Carbó and Antonio Doménech Carbó

CONTENTS

- 1 *Part I: Electroanalytical techniques*
- 2 La base de datos ElcHer como herramienta para la caracterización de productos de corrosión de objetos metálicos
Carolina Mai Cerovaz, María Teresa Doménech Carbó, Antonio Doménech Carbó
- 6 Application of electrochemical techniques to the characterization of metallic heritage *Antonio Doménech Carbó, María Teresa Doménech Carbó*
- 11 EIS/VIMP screening of archaeological bronze corrosion products
Jorge Redondo-Marugán, Antonio Doménech-Carbó, Sofia Capelo
- 18 Screening of monetary emissions in the transition of the Chinese Empire to the Republic by means of electrochemical techniques
Elena Montagna, Antonio Doménech-Carbó, María Teresa Doménech-Carbó, Yu Lee
- 23 Characterization of golden threads from *l'Almoína* site (Valencia, Spain) using electrochemical techniques
Betlem Martínez, Antonio Doménech-Carbó, María Teresa Doménech-Carbó
- 30 Electrochemical study of silver coins of the Antonini's Emperors
Francesca Di Turo, Noemí Montoya, Caterina De Vito, Fiorenzo Catalli, Gabriele Favero, Antonio Doménech-Carbó
- 36 *Part II: Analytical techniques*
- 37 Los metales arqueológicos vistos por dentro. La metalografía como instrumento diagnóstico
Salvador Rovira Llorens
- 46 Análisis físico – químicos de las primeras monedas acuñadas en Polonia
Carla Álvarez Romero, Julio M. del Hoyo Meléndez, María Teresa Doménech Carbó
- 53 Joanes, Borrás y Porta. Estudio técnico y analítico del tratamiento del oro en la pintura valenciana del Renacimiento
Amparo Castelló Palacios, María Teresa Doménech Carbó, Vicente Guerola Blay, Eva Pérez Marín
- 64 Discrimination of monetary emissions using Raman Spectroscopy
Noemí Montoya, Antonio Doménech-Carbó, María Teresa Doménech-Carbó, Elena Montagna, Yu Lee
- 69 *Part III: Conservation treatments*
- 70 Los objetos de cobre y bronce arqueológicos intensamente clorurados: posibilidades técnicas de intervención y perspectivas de conservación futura
Joaquín Barrio Martín, Ana Isabel Pardo Naranjo, Inmaculada Donate Carretero, María Cruz Medina Sánchez
- 82 Colaboración entre arqueólogos y restauradores en el Institut Català d'Arqueologia Clàssica
Anna Bertral Arias, Maria Carme Belarte Franco, Joan Canela Gràcia
- 90 Gestión y conservación del conjunto monetario de la fragata nuestra señora de las mercedes: restauración de 40.000 monedas
Juan Luis Sierra Méndez, Milagros Buendía Ortuño

- 96 Estudios científicos y tratamientos de conservación-restauración del conjunto de orfebrería medieval del museo de l'Almudi (Xàtiva)
Betlem Martínez Pla, Isabel Martínez Lázaro, Antonio Doménech-Carbó, M^a Teresa Doménech-Carbó
- 106 La joyería modernista. Las piezas de joyería de lluis masriera en el museo nacional de artes decorativas
Paula Armañanzas Ugarte
- 117 Llave ibérica de hierro procedente de la bastida de les alcusses (Moixent, Valencia). estudio radiográfico y restauración
Carla Renovell Anglés, Trinidad Pasies Oviedo, José Antonio Madrid García, Jaime Vives-Ferrándiz Sánchez
- 122 Piezas metálicas en los fondos del Museo de Prehistoria de Valencia: problemática asociada a su conservación y restauración
Trinidad Pasies Oviedo

Part I
Electrochemical techniques

EIS/VIMP SCREENING OF ARCHAEOLOGICAL BRONZE CORROSION PRODUCTS

Jorge Redondo-Marugán¹, Antonio Doménech-Carbó², Sofia Capelo³

¹ Institut de Restauració del Patrimoni, Universitat Politècnica de València, Camí de 8 Vera 14, 46022, València, Spain

² Departament de Química Analítica, Universitat de València, Dr. Moliner, 50, 46100 Burjassot (València) Spain

³ CIDEHUS & DPAO, Escola de Ciències e Tecnologia, Universidade de Évora, Rua Romão Ramalho 59, 7000-671 Évora Portugal

Corresponding author: Sofia Capelo and Antonio Doménech-Carbó. Email: scapelo@uevora.pt; Antonio.Domenech@uv.es.

Abstract

Electrochemical impedance measurements were applied to microparticulate deposits of copper corrosion products attached to graphite electrodes in contact with different aqueous electrolytes (0.25 M HAc/NaAc (pH 4.75), 0.10 M HCl and 0.10 M HClO₄) and the application of an interval of potentials between +0.25V to -0.75V. The conditions of operation were selected from a compromise between repeatability and sensitivity, being 0.10 M HClO₄ and bias potential of -0.25 V adopted. The electrochemical impedance data were modeled on the basis of available equivalent circuits for corroded metal surfaces and the correlation between several pairs of circuit elements provided the characterization of different corrosion compounds regardless the amount of microparticulate solid on the electrode. Electrochemical grouping of samples from the archaeological Roman site of Gadara (Jordan, 4th century AD) suggests different provenances/manufacturing techniques, consistent with voltammetry of immobilized particles (VIMP) measurements. Thus, illustrating the capabilities of the intersection of such techniques in the archaeometric domain.

Resumen

Medidas de impedancia electroquímica fueron aplicadas a depósitos microparticulados de productos de corrosión de cobre fijados en electrodos de grafito en contacto con diferentes electrolitos acuosos (0.25 M HAc/NaAc (pH 4.75), 0.10 M HCl y 0.10 M HClO₄) sobre los que se aplicó un intervalo de potenciales entre +0.25V y -0.75V. Las condiciones de operación se seleccionaron estableciendo un compromiso entre repetitividad y sensibilidad, usando 0.10 M HClO₄ y un potencial bias de -0.25 V. Los datos de impedancia electroquímica fueron modelados en base de circuitos equivalentes disponibles de superficies metálicas corroídas y la correlación entre varios pares de elementos de circuitos proporcionó la caracterización de diferentes compuestos de corrosión independientemente de la cantidad de sólido microparticulado en el electrodo. El agrupamiento electroquímico de muestras de el sito arqueológico de Gadara (Jordania 4 siglo AD) sugiere diferentes procedencias y técnicas de fabricación, en consistencia con las medidas de voltamperometría de partículas inmovilizadas (VIMP). De este modo, se ilustra la capacidad de intersección de estas dos técnicas en el dominio arqueológico.

KEY WORDS: Archaeological bronze; Electrochemical Impedance Measurements; Voltammetry of immobilized particles; Copper compounds; Copper corrosion products

1. INTRODUCTION

The identification of the constitutive materials of archaeological metal objects is an evident analytical demand for archaeologists, conservators and restorers. Tracing the provenance of the materials can be derived from the chemical composition of the alloy, isotope

ratios, and the microstructure of the alloy and patina from metallographic cross sections (Pernicka, 1998; Atanasio *et al.*, 2001; Scott, 2002; Constantinides *et al.*, 2002). Since sampling the metal core is in general not allowed for archaeological objects, the characterization of the metallic material, its provenance, manufacturing technique and situation within a defined chronological context have to be obtained from the physico-chemical

properties of the metal patina (Scott, 1994; Robbiola *et al.*, 1998; Robbiola and Portier, 2006; Sandu *et al.*, 2006).

These analytical targets have been faced using microstructural (metallographic) analysis, neutron diffraction and neutron absorption, isotope analysis, XRF spectrometry, and electron microscopy (SEM/EDX, TEM), among others (Bouchard and Smith, 2003; De Ryck *et al.*, 2003; Selwyn, 2004; Chiavari *et al.*, 2007; Figueiredo Junior *et al.*, 2007; Bernard and Joiret, 2009; Vlasa *et al.*, 2007). Such techniques provide important analytical capabilities but also have limitations, as discussed for isotope analysis and XRF, so that multi-technique approaches are usually recommended.

In the last years, the voltammetry of immobilized particles (VIMP) and the electrochemical impedance spectroscopy (EIS) have been added to the pool of existing techniques for the analysis of works of art and archaeological materials.

2. OBJECTIVES

The aim of this study was to test the possibility of intersecting the capabilities of the VIMP and the EIS methods in order to obtain information of archaeometric interest, namely to achieve correlations that could differentiate provenances/manufacturing techniques of the archeological artefacts.

2.1. EIS/ VIMP

Electrochemical impedance spectroscopy (EIS) is a technique providing information on the chemical, electrochemical and textural properties of surfaces. This technique has been extensively applied in corrosion studies (Macdonald, 2011; Sharifi-Asl *et al.*, 2013) and is of obvious application for the study of archaeological metals (Chiavari *et al.*, 2007; Souissi *et al.*, 2003; Souissi *et al.*, 2006; Souissi *et al.*, 2009; Mata *et al.*, 2010; Cano *et al.*, 2010).

The voltammetry of immobilized particles (VIMP), developed by Scholz and co-workers (Scholz and Meyer, 1998; Scholz *et al.*, 2014), is a technique based on the mechanical attachment of few micrograins of the solid material to the surface of an inert electrode, typically a paraffin-impregnated graphite electrode. The electrochemical response obtained upon immersion of that electrode into a suitable electrolyte is able to characterize the chemical and mineralogical composition of the solid. The characteristics of this technique are, in particular, its inherently high sensitivity, allowing for the identification of minerals using sample amounts at the nanogram level, as well as the possibility of multicomponent analysis, speciation and quantitation, made the same particularly interesting

for archaeometric purposes (Doménech-Carbó *et al.*, 2009; Doménech-Carbó, 2010; Doménech-Carbó *et al.*, 2013).

3. EXPERIMENTAL

3.1. Materials and samples

Reference materials were cuprite (Cu_2O , Merck), tenorite (CuO , Merck), atacamite (CuCl , De Haën). Malachite (K10300) was supplied by Kremer pigments, whereas brochantite and atacamite minerals were supplied by (Minerales de Colección, Almuñécar, Spain and Minerales de Torres, Villaviciosa de Odón, Spain). Samples consisted of ca. 500 mg of powders from the corrosion layers of different archaeological objects: 18 fragments of sculptures (samples S1 to S18) and two different sets of weights (W1-W3 and P1-P11), all extracted from the Roman archaeological site of Gadara (Jordan), 4th century AD.

For electrode conditioning, amounts between 0.1 and 1 mg of samples or reference materials were extended on an agate mortar forming a spot of finely distributed material. Then, the graphite electrode was pressed over this layer being further transferred into the electrochemical cell so that only the lower end of the electrode was in contact with the electrolyte.

3.2. Electrochemical instrumentation and procedures

VIMP and EIS experiments were performed at sample-modified paraffin-impregnated graphite electrodes using commercial graphite bars (Staedtler Mars 200 HB, 2.0 mm diameter). Air-saturated 0.25 M HAc/NaAc (pH 4.75), 0.10 M HCl and 0.10 M HClO_4 aqueous solutions were used as electrolytes. No degasification was carried out in order to test the possibility of using the electrochemical reduction of dissolved oxygen as a redox probe. All electrochemical measurements were carried out using a CH I660 potentiostat. A standard three-electrode arrangement was used with a platinum auxiliary electrode and a Ag/AgCl (3M NaCl) reference electrode.

EIS measurements were performed, using the aforementioned instrument, in the 0.01 to 100000 Hz frequency range with amplitude of 10 mV at different potentials between +1.00 and -1.00 V upon immersion of the sample-modified graphite electrode into the electrolyte. Three independent experiments were performed for each sample after transferring different amounts of the same onto the electrode surface. Prior to each EIS experiment, an equilibration time of 5 min was taken.

4. RESULTS AND DISCUSSION

4.1. Impedance measurements/Modeling

For this purpose, copper minerals that are usually present in the corrosion products of archaeological artefacts such as cuprite (copper(I) oxide), tenorite (copper oxide) malachite (copper hydroxycarbonates), brochantite (copper hydroxysulfates) and atacamite (copper hydroxychlorides) were used as standards, to compare the results obtained from these patterns with those of archaeological artefacts samples.

In order to achieve differences in the response between the copper mineral standards and also with the bare electrode, the electrolyte and the bias potential were selected. Experiments on microparticulate deposits of cuprite and malachite (and at the bare electrode) abrasively transferred on a graphite bar were performed in contact with different aqueous electrolytes (0.25 M HAc/NaAc, pH 4.75; 0.1M HCl and 0.10 M HClO₄) applying bias potentials between +0.25 and -0.75 V vs. Ag/AgCl.

As can be observed in figure 1, small differences in the maximum phase angle between the bare electrode, cuprite and malachite were observed for 0.25 M HAc/NaAc (pH 4.75), as well as for 0.1M HCl. However, with 0.10 M HClO₄ as electrolyte at -0.25 V, relatively high differences between the bare electrode, cuprite and malachite were obtained. The conditions of operation were selected from a compromise between repeatability and sensitivity, being 0.10 M HClO₄ and bias potential of -0.25 V adopted.

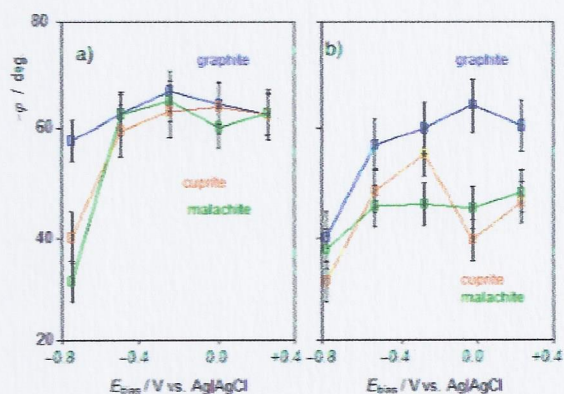

Figure 1. Variation with the bias potential of the value of the maximum phase angle at intermediate frequencies in EIS experiments at cuprite and malachite-modified graphite electrodes in contact with air-saturated: a) 0.25 M HAc/NaAc at pH 4.75, and b) 0.10 M HClO₄ aqueous solutions. Mean values of three replicate experiments are represented.

To test the influence of the amount of mineral transferred onto the electrode surface on the EIS

spectra, variations with the amount of deposited mineral were performed. From the Nyquist plots for the bare graphite electrode and three cuprite-modified graphite electrode immersed in 0.10 M HClO₄ at a bias potential of -0.25 V, can be seen that on increasing the amount of cuprite, the size of the capacitive loop decreases significantly, thus denoting that the overall impedance decreases concurrently (Figure 2).

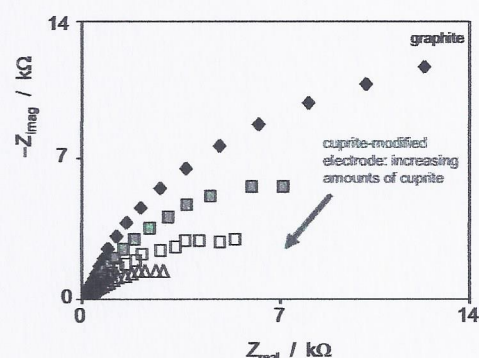

Figure 2. Nyquist plots from impedance measurements on an unmodified graphite electrode and three cuprite-modified graphite electrodes containing different mineral loadings immersed into air-saturated 0.10 M HClO₄ aqueous solutions. Bias potential of -0.25 V.

Several parameters, such as the Log ($-Z_{imag}$) at the extreme of low frequencies (0.01 Hz) versus the Log (Z_{real}) at the same frequency displayed monotonic variations with the amount of deposited mineral, defining trend curves characterizing each one of the compounds (Figure 3).

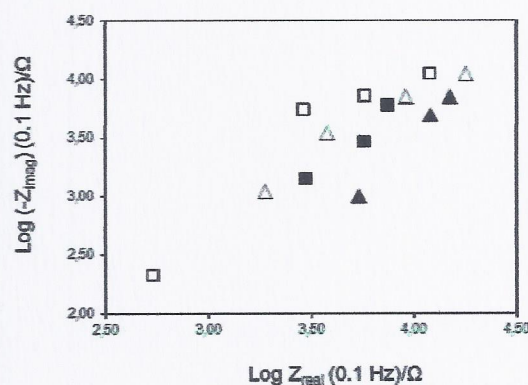

Figure 3. Plots of $\text{Log}(-Z_{imag})$ at 0.1 Hz vs. $\text{Log} Z_{real}$ at 0.1 Hz from impedance measurements on graphite electrodes modified with deposits of cuprite (squares), malachite (solid squares), brochantite (triangles) and atacamite (solid triangles) immersed into air-saturated 0.10 M HClO₄ aqueous solutions at pH 1.0. Bias potential of -0.25 V. Data for successive runs on the same modified electrode and the 1st run on electrodes containing different mineral loadings are superimposed.

For modeling the obtained EIS spectra, the simplest equivalent circuit from Lee and Pyun was used (Lee and Pyun, 2007). This includes a first resistance (R_s), corresponding to the solution resistance, in series to two parallel branches. The first branch contains a parallel association of the charge transfer resistance (R_{ct}) at the graphite/electrolyte interface and the double layer capacitance (C_{dl}). The second branch connects in parallel a constant phase element (Q_p) and a resistance (R_p) associated to the insulating particles partially covering the graphite electrode. The fitting to experimental data was significantly improved adding to this second branch an additional resistance (R_i) as schematized in Figure 4. This model was satisfactorily fitted to the majority of experimental data.

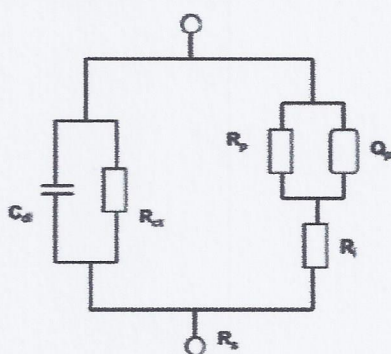

Figure 4. Equivalent circuits used to model EIS spectra of reference compounds and samples S1 to S17 and W1 to W3.

4.2. Voltammetry of immobilized particles

Almost all copper minerals used as standard reduces at the potential selected (-0.25 V vs. Ag/AgCl), except tenorite. In fact, the voltammetric response of the more frequent copper corrosion products such as cuprite, malachite, atacamite and brochantite, in contact with 0.10 M HClO_4 , occurs at ca. -0.10 V vs. Ag/AgCl, corresponding to the reduction to Cu metal, whereas tenorite was reduced at potentials ca. -0.4 V vs. Ag/AgCl.

4.3. Sample analysis

A series of samples from Roman site of Gadara (Jordan, 4th century AD) were studied. The samples consisted of powdered materials from highly corroded bronze artifacts. For the experimental conditions of VIMP and EIS experiments, the graphite electrode was covered by a discontinuous layer of grains of the corresponding solid copper compound or archaeological sample.

The VIMP analysis of the archeological samples was performed using aqueous acetate buffer as the electrolyte to be possible the comparison with previous studies (Doménech-Carbó *et al.*, 2010; 2014; 2016). The studied samples can be grouped into two main

electrochemical types (Figure 5). The first one with the presence of two cathodic peaks, one at -0.10 V vs. Ag/AgCl (C_1), attributable to the reduction of copper corrosion products, and other near -0.70 V vs. Ag/AgCl, corresponding to the reduction of dissolved oxygen (C_{ox}), when considering the negative direction (Figure 5a). In the positive-going potential scan (Figure 5b), only a broad anodic peak at $+0.05$ V vs. Ag/AgCl (A_1) was recorded, corresponding to the oxidative dissolution of the deposit of metallic copper resulting from the electrochemical reduction of copper corrosion products.

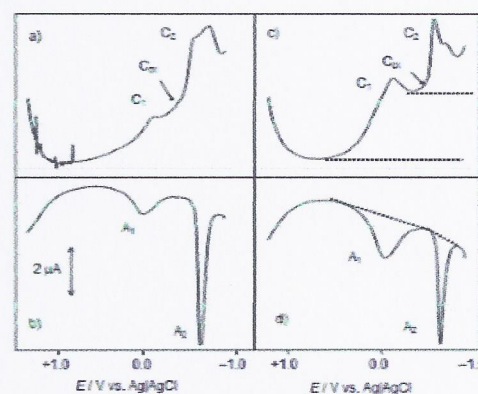

Figure 5. Square wave voltammograms of samples a,b) W1 and c,d) WP16 attached to graphite electrode immersed into 0.25 M HAc/NaAc aqueous solution at pH 4.75. Potential scan initiated a)/c) at $+1.25$ V in the negative direction and b)/d) -0.85 V in the positive direction. Potential step increment 4 mV; square wave amplitude 25 mV; frequency 5 Hz.

For the second type of samples three cathodic peaks were recorded in the negative-going potential scan. C_1 was accompanied by two overlapping tall peaks at -0.57 and -0.72 V vs. Ag/AgCl (conjointly labeled as C_2) superimposed to the C_{ox} background shoulder (Figure 5c).

The group of peaks C_2 can be mainly attributed to the reduction of lead corrosion products, eventually superimposed to the reduction of tenorite (CuO) that appears at the same negative potential.

The presence of lead was confirmed by the appearance, in the positive-going scan (Figure 5d), of a sharp anodic peak at -0.55 V vs. Ag/AgCl, (A_2), corresponding to the oxidative dissolution of the metallic lead as a result of its reduction of leaded corrosion products, accompanying the oxidation of copper (A_1) at $+0.05$ V vs. Ag/AgCl.

Several quantities directly measured on the EIS spectra varied systematically with the amount of sample, as obtained for reference materials. In addition, several pairs of samples produced a well-defined grouping of the samples (Figure 6 and 7).

The variation of R_p on R_i , calculated from curve fitting using the equivalent circuit in Figure 4 for impedance data for microparticulate deposits having different amounts of solid samples and copper compounds attached to graphite in contact with air-saturated 0.10 M HClO_4 solution is showed in Figure 6 and 7.

As can be seen in Figure 6, the EIS response of the studied archeological samples (S3 and W3) was similar to that of tenorite, meaning that tenorite predominate in their composition.

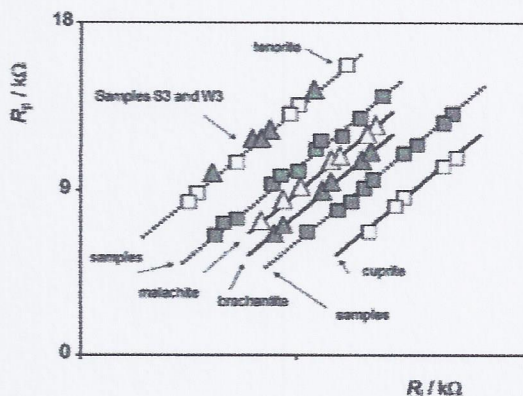

Figure 6. Electrochemical impedance measurements performed on different copper corrosion products and samples S3 and W3 on graphite in contact with air-saturated 0.10 M HClO_4 solution at pH 1.0. Variation of R_p on R_i , calculated from curve fitting using the equivalent circuit in Figure 4, for microparticulate deposits having different amounts of solid.

As can be seen in Figure 7, the continuous lines correspond to cuprite, malachite and tenorite. Data points for samples S1 to S5 (solid squares) and W1 to W3 (squares) fall in the region between cuprite and tenorite lines thus suggesting a common pattern which more or less intense corrosion. Samples S6 to S17, however, fall in a region around a straight line (dotted line) beyond the tenorite line.

Taking into account that all samples were extracted from a common archaeological context, the above feature suggested that such samples were constituted by a different metallic substrate.

Notably, the data points for sample S18 (triangles), contained relatively large amounts of lead as denoted by VIMP, were clearly separated from that corresponding to copper corrosion products and can be attributed to the distorting effect associated to lead.

5. CONCLUSIONS

The following main conclusions can be draw:

. Electrochemical impedance measurements can be modeled on the basis of available equivalent circuits for corroded metal surfaces and the correlation between several pairs of circuit elements provide monotonic

variations which are able to characterize different corrosion compounds regardless the amount of microparticulate solid on the electrode.

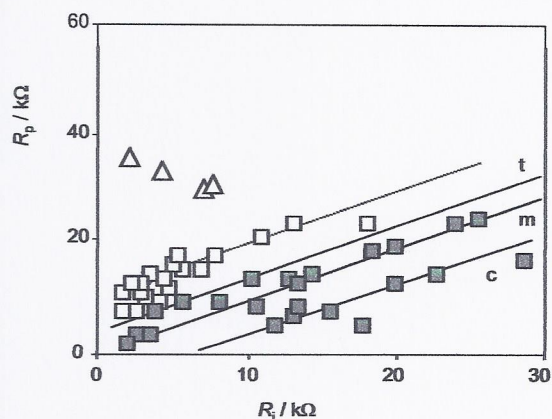

Figure 7. Variation of R_p on R_i , calculated from curve fitting using the equivalent circuit in Figure 4, for microparticulate deposits having different amounts of solid samples attached to graphite in contact with air-saturated 0.10 M HClO_4 solution. Continuous lines correspond to cuprite (c), malachite (m) and tenorite (t). Solid squares: samples S1 to S5; squares: samples S6 to S17; triangles: sample S18.

Application of impedance measurements to a set of archaeological samples from the archaeological Roman site of Gadara (Jordan, 4th century AD) permitted to establish a sample grouping which was entirely consistent with that derived from VIMP measurements, thus illustrating the capabilities of the intersection of such techniques in the archaeometric domain.

ACKNOWLEDGEMENTS

Financial support from the MINECO Projects CTQ2014-53736-C3-1-P and CTQ2014-53736-C3-2-P which are also supported with ERDF funds and Grants ES-2012-052716 and EEBB-I-16-11558 is gratefully acknowledged.

REFERENCES

- Attanasio, D., Bultrini, G., Ingo, G.M. (2001) "The possibility of provenancing a series of bronze punic coins found at Tharros (Western Sardinia) using the literature lead isotope database" en *Archaeometry* 43, pp. 529–547.
- Bernard, M.C. Joiret, S. (2009) "Understanding corrosion of ancient metals for the conservation of cultural heritage" en *Electrochimica Acta* 54, pp. 5199–5205.
- Bouchard, M., Smith, D.C. (2003) "Catalogue of 45 references Raman spectra of minerals concerning

- research in art history of archaeology, especially on corroded metal and coloured glass” en *Spectrochimica Acta A* 59, pp. 2247–2266.
- Cano, E., Lafuente, D. Bastidas, D.M. (2010) “Use of EIS for the evaluation of the protective properties of coatings for metallic cultural heritage: a review” en *Journal of Solid State Electrochemistry* 14, pp. 381–391.
- Chiavari, C., Rahmouni, K., Takenouti, H., Joiret, S., Vermaut, P. Robbiola, L. (2007) “Composition and electrochemical properties of natural patinas of outdoor bronze monuments” en *Electrochimica Acta* 52, pp. 7760–7769.
- Constantinides, I.; Adriaens, A. and F. Adams, (2002) “Surface characterization of artificial corrosion layers on copper alloy reference materials” en *Applied Surface Science* 189, pp. 90–101.
- De Ryck, I., Adriaens, A., Pantos, E., Adams, F. (2003) “A comparison of microbeam techniques for the analysis of corroded ancient bronze objects” en *Analyst* 128, pp. 1104–1119.
- Doménech-Carbó, A., Doménech-Carbó, M.T., Martínez-Lázaro, I. (2010) “Layer-by-layer identification of copper alteration products in metallic works of art using the voltammetry of microparticles approach” en *Analytica Chimica Acta* 610, pp. 1–9.
- Doménech-Carbó, A., Doménech-Carbó, M.T., Capelo, S.; Pasies, T., Martínez-Lázaro, I. (2014) “Dating archaeological copper/bronze artifacts using the voltammetry of microparticles” en *Angewandte Chemie International Edition* 53, pp. 9262–9266.
- Doménech-Carbó, A., Doménech-Carbó, M.T., Redondo-Marugán, J., Osete-Cortina, L., M.V. Vivancos-Ramón, (2016) “Electrochemical characterization of corrosion products in leaded bronze sculptures considering ohmic drop effects on Tafel analysis” en *Electroanalysis* 28, pp. 833–845.
- Doménech-Carbó, A.; Doménech-Carbó, M. T. and V. Costa, (2009) “Electrochemical Methods in Archaeometry”, Scholz, F., Ed., *Conservation and Restoration*. Berlin-Heidelberg, Springer - Monographs in Electrochemistry Series.
- Doménech-Carbó, A., (2010) “Voltammetric methods applied to identification, speciation and quantification of analytes from works of art: an overview” en *Journal of Solid State Electrochemistry* 14, pp. 363–369.
- Doménech-Carbó, A., Labuda, J., F. Scholz, (2013) “Electroanalytical chemistry for the analysis of solids: characterization and classification (IUPAC Technical Report)” en *Pure and Applied Chemistry* 85, pp. 609–631.
- Figueiredo Junior, J. Cura D’Ars de, Freitas Cunha Lins, V. de De Bellis, V.M. (2007) “Surface characterization of a corroded bronze-leaded alloy in a salt spray cabinet” en *Applied Surface Science* 253, pp. 7104–7107.
- Lee, S.J., Pyun, S.L. (2007) “Assessment of corrosion resistance of surface-coated galvanized steel by analysis of the AC impedance spectra measured on the salt-spray-tested specimen” en *Journal of Solid State Electrochemistry* 11, pp. 829–839.
- Macdonald, D.D., (2011) “The history of the point defect model for the passive state: a brief review of film growth aspect” en *Electrochim. Acta* 56, pp. 1761–1772.
- Mata, A.L., Salta, M.M.L., Neto, M.M.M., Mendonça, M.H., Fonseca, T.E. (2010) “Characterization of two Roman coins from an archaeological site in Portugal” en *Materials Corrosion* 61, pp. 205–210.
- Pernicka, E., (1998) “Whither metal analysis in archaeology?”, en C. Mordant, M. Pernot, and V. Rychner, Eds., *L’atelier du bronzier en Europe du XXe au VIIIe siècle avant notre ère, Bronze ’96*. Paris, Comité des Travaux Historiques et Scientifiques -Tome I, pp. 259–267.
- Robbiola, L., Blengino, J.M., Fiaud, C. (1998) “Morphology and mechanisms of formation of natural patinas on archaeological CuSn alloys” en *Corrosion Science* 40, pp. 2083–2111.
- Robbiola, L. and R. Portier, (2006) “A global approach to the authentication of ancient bronzes based on the characterization of the alloy–patina–environment system” en *Journal of Cultural Heritage* 7, pp.1–12.
- Sandu, I., Marutoiu, C., Sandu, I.G., Alexandru, A., A.V. Sandu, (2006) “Authentication of Old Bronze Coins I. Study on Archaeological Patina” en *Acta Universitatis Cibinensis Section F Chemia* 9, pp. 39–53.
- Selwyn, L., (2004) *Metals and corrosion: a handbook for the conservation professional*. Ottawa, Canadian Conservation Institute, pp. 122–123.
- Scott, D.A., (2002) *Copper and bronze in art: corrosion, colorants and conservation, II*. Los Angeles, Getty Publ.
- Scholz, F., B. Meyer, (1998) “Voltammetry of solid microparticles immobilized on electrode surfaces.” In Bard, A. J., and Rubinstein, I., Eds., *Electroanalytical Chemistry, A Series of Advances*, Marcel Dekker. New York 20, pp. 1–86.

Scholz, F., Schröder, U., Gulaboski, R., A. Doménech-Carbó, (2014) *Electrochemistry of Immobilized Particles and Droplets*. 2nd Edition. Berlin-Heidelberg, Springer.

Scott, D.A., (1994) “An examination of the patina and corrosion morphology of some Roman bronzes” en *Journal of the American Institute of Conservation* 33, pp. 1–23.

Sharifi-Asl, F.; Taylor, M. L.; Lu, Z., Engelhardt, G.L.; Kursten, B., D.D. Macdonald. (2013) “Modeling of the electrochemical impedance spectroscopic behavior of passive iron using a genetic algorithm approach” en *Electrochimica Acta* 102, pp. 161–173.

Souissi, N.; Bousselmi, L.; Khosrof, S., E. Triki, (2003) “Electrochemical behaviour of an archaeological bronze alloy in various aqueous media: New method for

understanding artifacts preservation” en *Materials Corrosion* 54, pp. 318–325.

Souissi, N.; Triki, E.; Bousselmi, L., S. Khosrof, (2006) “Comparaison between archaeological and artificially aged bronze interfaces” en *Materials Corrosion* 57, pp. 794–799.

Souissi, N., E. Triki, (2009) “Characterization of ethnographic copper corrosion” en *Materials Corrosion* 60, pp. 262–268.

Vlasa, A.; Varvara, S., L. Muresan, (2007) “Electrochemical investigation of the influence of two thiadiazole derivatives on the patina of an archaeological bronze artefact using a carbon paste electrode” en *Studia Chemia, LII*, 2, pp. 63–73