

## Numerical Particle Transport in Partitioned Room

MURAT AYDIN<sup>a,b</sup>, ANTONIO F. MIGUEL<sup>b,c</sup> AND A. HEITOR REIS<sup>b,c</sup>

<sup>a</sup> Institute of Energy, Istanbul Technical University, 34469 Maslak, Istanbul, TURKEY

<sup>b</sup> Évora Geophysics Center, R. Romão Ramalho, 59, 7000-671 Évora, PORTUGAL

<sup>c</sup> Physics Department, University of Évora, R. Romão Ramalho, 59, 7000-671 Évora, PORTUGAL

[aydinmurat@itu.edu.tr](mailto:aydinmurat@itu.edu.tr) <http://www.energy.itu.edu.tr/> <http://www.dfis.uevora.pt/>

<http://www.cge.uevora.pt/>

**Abstract:** - In this work, we solved particle transport in a two-zone enclosure numerically with different airflow patterns, particle properties and also source positions. A discrete trajectory was employed for the particle movement. Five isotropic line sources which are all taken at different positions of the same zone were tested. It was observed that for all airflow patterns, residence time increases with decreasing size of particles. Increase in size and mass increases the chance of particles to get deposited onto the floor. Source locations should be chosen in the main stream of the flow so that particles convect fast through and not contribute indoor pollutant concentration. Conclusions were drawn for every numerical experiment in order to show tendencies of particle dynamics within the enclosure.

**Key-Words:** - Aerosol Particles, Transport, Deposition, Ventilation, Source, Indoor

### 1 Introduction

In modern society, people spend most of their time indoor and are constantly exposed to particles. Indoor particles have multiple origins from outdoor soil dust, building materials, to occupants and their activities. Knowledge of transport and deposition of these particles in indoor environments is important in addressing questions concerning occupational exposure, associated health risks and also implementing cleaning strategies [1, 2].

Aerosol particle movements and deposition are investigated by many researchers. Among them, Miguel and Silva experimentally studied particle deposition on a flat plate with various slopes [3]. Lu et al. calculated aerosol particle migration and deposition in a two zone chamber and compared their predictions with corresponding experimental measurements [4]. Lee and Awbi investigated the effect of internal partitioning on the room air quality and ventilation [5]. Zhao et al. studied air movement and aerosol particle concentration and deposition in displacement and mixing ventilation rooms numerically [6]. Aydin et al. obtained equilibrium particle distribution in a cavity and also a ventilated room [7, 8]. Recently, Miguel et al. studied effects of air humidity and currents and electrical charges upon indoor particle deposition experimentally [9].

In this work, the movement of particles is investigated considering airflow patterns, particle

properties and source positions in a model room. Airflow pattern is changed by altering the location of the outlet (exhaust). Three different locations were tested. The particles used in the study vary from 1 to 100  $\mu\text{m}$  with two different densities of ( $\rho_p=240 \text{ kg/m}^3$ ) and ( $\rho_p=2300 \text{ kg/m}^3$ ) representing light and heavy materials. Five line sources are considered in one zone of the enclosure. Particles are all released homogeneously and isotropically with the same initial conditions

### 2 Computational Fluid Dynamics

A square cavity with dimensions of 2.5 m in length and 2.5m in height is considered here. At the middle of the cavity a partition half way down to its height is used, which divides it into two connected zones. In each configuration air is supplied through the same location while exhaust (outlet) location is changed (see Fig. 1).

The steady state flow field is defined by the Navier-Stokes equations together with the standard k- $\epsilon$  two-equation model of turbulence and solved numerically with the finite volume method [10]. The airflow is assumed to be incompressible. The non-slip boundary conditions are set along walls of the enclosure and also surfaces of the partition. The flat velocity profile is prescribed at the inlet while pressure outlet boundary conditions are set at the outlet.

A homogeneously distributed noded grid was employed at first run and then, the cell size of the grid

where high gradients of velocities exist has been varied gradually to ensure a grid independent solution. The final form of the grid for outlet V1 can be seen in Fig. 2.

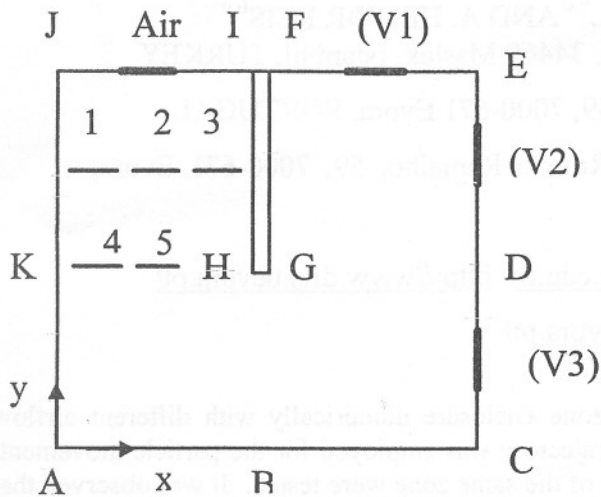

Fig.1 Geometrical configuration: 1-5 show source positions and V1-V3 represent outlet positions

The grid with 18092 quadrilateral cells and 19080 nodes are found to be appropriate for this study.

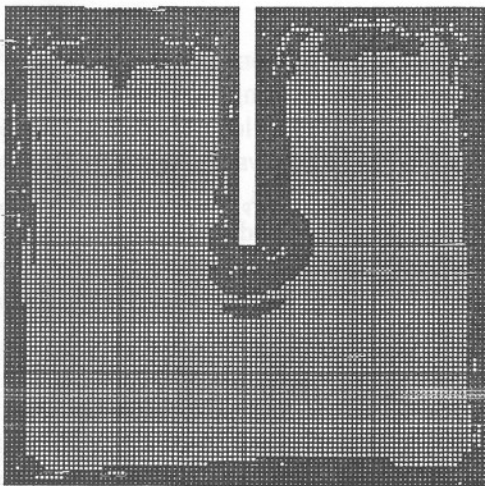

Fig.2 Grid of the domain for outlet V1

Reynolds number  $Re$  is calculated according to  $\rho u D_h / \mu$ , where  $\rho$  is density of air,  $u$  is velocity at the supply,  $\mu$  is dynamic viscosity of air,  $D_h$  is the hydraulic diameter of the room, which was 2.5 m. Under relaxation factors were arranged to ensure convergence in the solution. Airflow pattern is changed by shifting the location of the outlet. Three different locations were tested. Contours of stream function at  $Re=170000$  are shown in Fig. 3. This shows four asymmetric slowly recirculating regions located at the corners

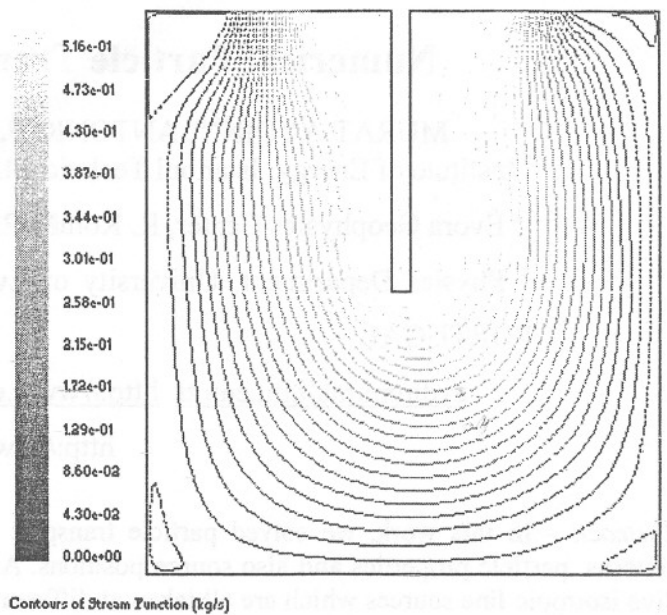

Fig.3 Contours of Stream Function for V1

### 3 Particle Dynamics

Once the solution of air flow has been obtained, each particle trajectory was then calculated. A fixed continuous phase flow field was assumed, in other words, the particles do not modify significantly the air flow (uncoupled approach). All particles are assumed to be spherical. The trajectory of a particle is predicted by integrating the force balance on the particle. This force balance equates the particle inertia with forces acting on the particle and can be written as

$$d\vec{u}_p / dt = \vec{F}_a - F_D (\vec{u} - \vec{u}_p) + \frac{\mu (\rho_p - \rho)}{\rho_p} \quad (1)$$

where  $\vec{F}_a$  represents additional forces such as lift force due to shear, the force due to the pressure gradient in air and the Brownian force [11], and  $F_D (\vec{u} - \vec{u}_p)$  is the drag force per unit mass and

$$F_D = \frac{18\mu C_D Re}{\rho_p d_p^2} \quad (2)$$

Here  $u$  is the air velocity,  $u_p$  is the particle velocity,  $\mu$  is the viscosity of air,  $\rho$  is the air density,  $\rho_p$  is the density of the particle, and  $d_p$  is the particle diameter. The last term in Eq.1 stands for the buoyancy force.

In the case of larger particles, Eq.1 becomes an ordinary deterministic differential equation due to the exclusion of Brownian term, which brings stochastic character to it. Therefore, its solution is straightforward as long as initial conditions are given.

The trajectory equations are solved by stepwise integration over time steps. The integration time step is computed based on a specified length scale ( $L$ ) and the

velocity of the particle and of the continuous phase as  $\Delta t = \frac{L}{u_p + u}$ . Integration in time of Eq.1 yields the

velocity of the particle at each point along the trajectory, with the trajectory itself predicted by

$$\frac{d\mathbf{r}}{dt} = \mathbf{u}_p \quad (3)$$

Equations (1) and (3) are solved to predict the trajectories of particles.

### 3 Results

Particles are tracked until they hit surfaces. Five source locations for the particles are considered in the volume of the left zone (see Table 1). Note that all locations were given in dimensionless coordinates ( $x^* = x/D_h$ ,  $y^* = y/D_h$ ). For each calculation and at every source location, 100 particles homogeneously distributed in each source location are released exactly with the same initial conditions. Injected particles were all tracked down until they leave the domain or hit surfaces of the enclosure. Rebounding was not considered. Cork ( $\rho_p=240 \text{ kg/m}^3$ ) and concrete materials ( $\rho_p=2300 \text{ kg/m}^3$ ) of sizes 1, 10 and 100  $\mu\text{m}$  were considered. This lets the range of densities, which most of solid indoor contaminants fall in between.

Table 1 Source Locations

Source No	$x^*_{\min}$	$x^*_{\max}$	$y^*$
1	0.04	0.08	0.88
2	0.22	0.26	0.88
3	0.40	0.44	0.88
4	0.04	0.08	0.50
5	0.22	0.26	0.50

#### 2.1 Effect of Particle Sizes

The typical trajectories of 3 particles of sizes 1, 10 and 100  $\mu\text{m}$  placed initially at the same place ( $x^*=0.25$  and  $y^*=0.88$ ) for V-1 (i.e. outlet location in V-1) are shown in Fig. 4. Among them, the concrete particle with the size of 100  $\mu\text{m}$  deposits on the floor due to gravity while all others leave the room. Particles with 1 $\mu\text{m}$  size follow air streamline. However, they are affected by Brownian motion and this effect as small deviations from streamline is visible.

#### 2.2 Effect of Airflow Patterns

A maximum number of  $10^6$  time steps is used as to prevent the possibility of a particle being caught in a re-

circulating region of the flow field and being tracked infinitely.

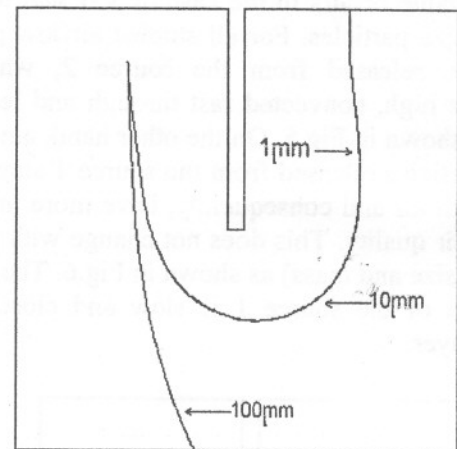

a) concrete particles

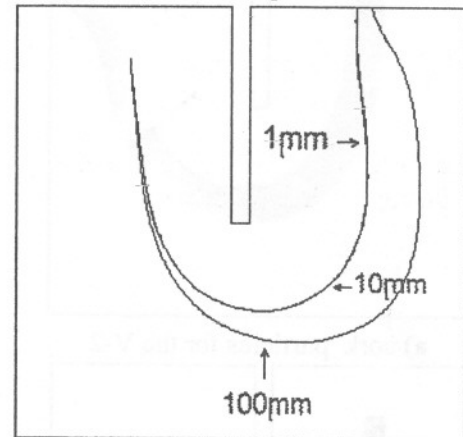

b) cork particles

Fig.4 Typical trajectories of 3 particles of sizes 1, 10 and 10  $\mu\text{m}$  placed initially at the same place for V-1

For all airflow patterns (V1-V3), residence time increases with decreasing particle size (for both concrete and cork). This means they stay longer suspended in air, therefore giving the main contribution to indoor pollutant concentration. For heavier particles, the deposition probability is high due to gravity. The chance that small size particles get deposited onto the ceiling is high. This chance becomes higher for lighter particles. For all airflow patterns, while particle deposition probability is the highest for the outlet V-1 whereas the V-2 is found to be the most efficient in terms of particle escaping probability. The V-3 is close to the recirculation region at the corner. This increases the possibility of a particle being caught in this region. As a result, it is wise to choose outlets on sidewalls. Most of deposition occurs on floor surfaces. Therefore, it would be more efficient for filters for collecting deposited particles if positioned on sidewalls close to floor surface.

### 2.3 Effect of Source Locations

For all airflow patterns, source 1 (see Fig.1) gives the highest contribution in deposition on the ceiling. The maximum value occurs in the case of V-1 and for light and small size particles. For all studied airflow patterns all particles released from the source 2, where air velocities is high, convected fast through and leave the domain as shown in Fig.5. On the other hand, among the sources, particles released from the source 1 stay longer suspended in air and consequently, have more influence on indoor air quality. This does not change with particle properties (size and mass) as shown in Fig.6. The flow at the location of the source 1 is slow and close to the boundary layer.

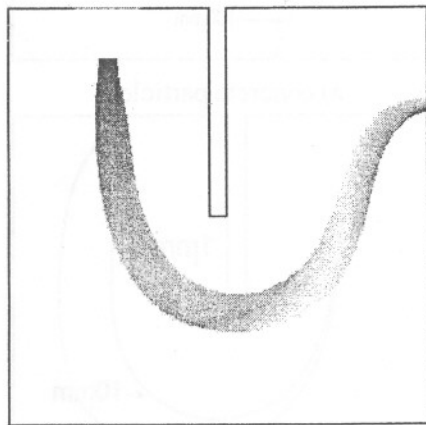

a) cork particles for the V-2

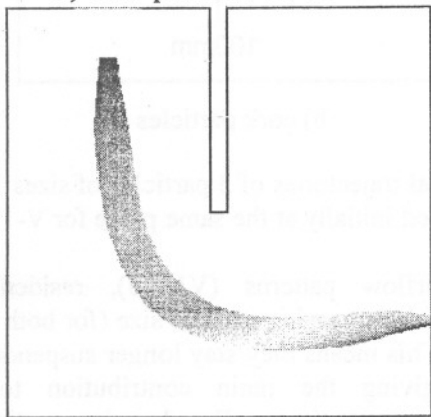

b) concrete particles for the V-3

Fig.5 Trajectories of particles of size 100 μm released from Source 2

Whatever mass and size of the particles are, particles released from sources 4 and 5 for both V2 and V3 leave the room without deposition.

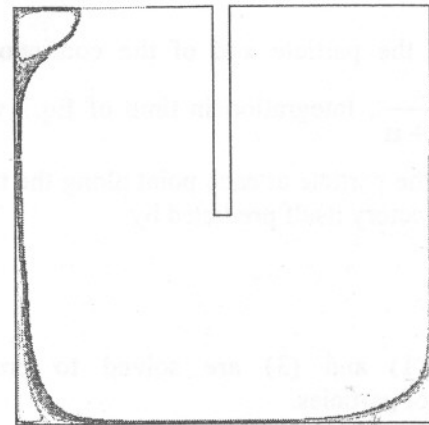

a) 10 μm concrete particles for the V-2

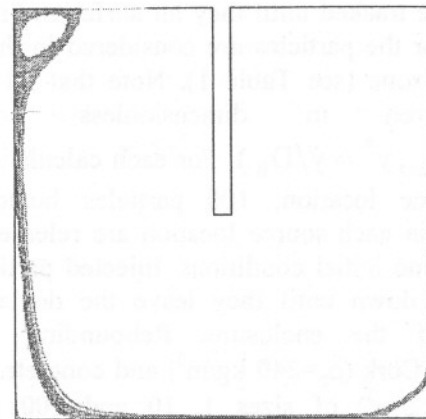

b) 1 μm cork particles for the V-3

Fig.6 Trajectories of particles released from Source 1

For all airflow patterns, the effect of the partitioning on deposition is more significant when particles are released from source 3 as shown in Fig.7. Increase in size and mass increases the chance of particles to get deposited on the floor.

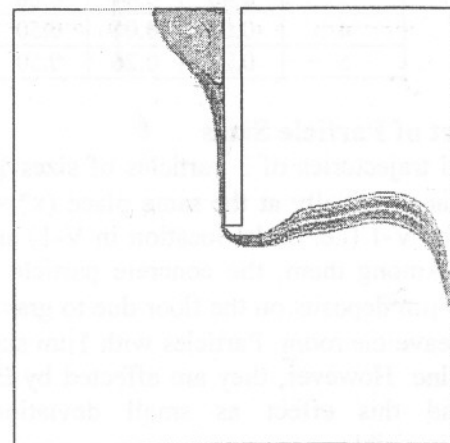

Fig.7 Trajectories of 1 μm concrete particles released from Source 3 for V-3

#### 4 Conclusion

Movement of particles is investigated considering the factors of airflow patterns, particle characteristics and source positions in a model room. For all airflow patterns, residence time increases with decreasing size (for both heavy and light particles). This means they stay longer suspended in air and therefore, contributing significantly to indoor pollutant concentration, which confirms the findings of Lu et al [4]. For larger particles, the probability to get deposited is higher due to gravity. Increase in size and mass increases the chance of particles to get deposited onto the floor. This is in agreement with the literature [4, 6]. Airflow pattern and source locations have important influences upon indoor air quality. Particles entrained in main flow stream easily convect and leave the room. Particles captured in a recirculating region of the flow field have more residence times in the room and consequently, contribute significantly indoor pollutant concentration.

Finally, the approach presented in this paper can be extended to more interesting indoor cases and three-dimensional deposition problems.

**Acknowledgments** - This work is a part of the project supported by the Foundation for the Science and Technology (FCT) (project POCTI/EME/59909/2004).

#### References:

- [1] Awbi HB, *Ventilation of Buildings*, E&F Spon, London, 1995.
- [2] Reis AH, Miguel AF and Aydin M, Constructal Theory of Flow Architecture of the Lungs, *Medical Physics*, Vol. 31, 2004, pp.1135-1140.
- [3] Miguel AF and Silva AM, Particle Deposition onto a Flat Plate with Various Slopes, *Journal of Aerosol Science*, Vol. 34, 2003, pp. 667-668.
- [4] Lu W, Howarth AT, Adam N and Riffat SB, Modelling and Measurement of Airflow and Aerosol Particle Distribution in a Ventilated Two-Zone Chamber, *Building Env*, Vol. 31, 1996, pp.417-423.
- [5] Lee H and Awbi HB, Effect of Internal Partitioning on Indoor Air Quality of Rooms with Mixing Ventilation-Basic Study, *Building Env*, Vol.39, 2004, pp. 127-141.
- [6] Zhao B, Zhang Y, Li X, Yang X and Huang D, Comparison of Indoor Aerosol Particle Concentration and Deposition in Different Ventilated Rooms by Numerical Method, *Building Env*, Vol.39, 2004, pp. 1-8.
- [7] Aydin M, Reis AH, Miguel AF and Silva A M: Particle Transport in a Two-Zone Enclosure, *9<sup>th</sup> International Conference on Air Distribution in Rooms (ROOMVENT2004)*, Coimbra, Portugal, 5-8 September 2004.

- [8] Aydin M, Reis AH, Miguel AF: Particle Distribution in a Cavity at High Reynolds Number Flow: *Proceedings of the First Cappadocia International Mechanical Engineering Conference CEMS 2004*, Cappadocia, Turkey, Vol 2, 2004, pp 455-461.
- [9] Miguel AF, Aydin M and Reis AH, Indoor deposition of forced re-suspension of respirable particles *Indoor and Built Environment*, vol. 14, No 15, 2005, pp. 391-396.
- [10] FLUENT 6 User's Guide, *Fluent Inc.*, 2003.
- [11] Bejan, A., Dincer, I., Lorente, S., Miguel, A. F. and Reis, A. H., *Porous and Complex Flow Structures in Modern Technologies*, Springer, New York, 2004