

**JORGE MANUEL PESTANA FORTE DE OLIVEIRA**

**MONUMENTOS MEGALÍTICOS  
DA  
BACIA HIDROGRÁFICA DO RIO SEVER**

( Marvão, Castelo de Vide, Nisa, Valência de Alcântara,  
Herrera de Alcântara e Cedillo )

**VOL. 3/3**

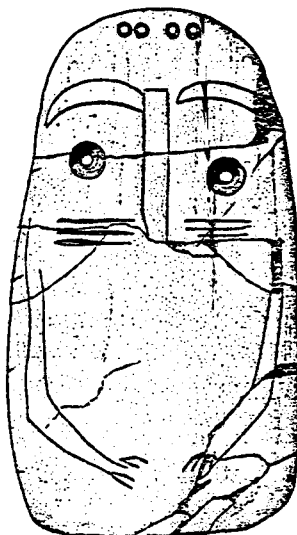

Universidade de Évora  
1995

**JORGE MANUEL PESTANA FORTE DE OLIVEIRA**

**MONUMENTOS MEGALÍTICOS  
DA  
BACIA HIDROGRÁFICA DO RIO SEVER**

( Marvão, Castelo de Vide, Nisa, Valência de Alcântara,  
Herrera de Alcântara e Cedillo )

VOL. 3/3



80065-

Universidade de Évora  
1995

**CATÁLOGO**

**MATERIAIS ARQUEOLÓGICOS**

**- desenhos e descrições -**

# CATÁLOGO DOS MATERIAIS ARQUEOLÓGICOS

## - Monumentos Megalíticos -

### NOTA EXPLICATIVA

1.

Procura-se com o presente catálogo, mais do que descrever pormenorizadamente cada peça, registar a sua localização tridimensional no espaço que ocupava na altura da sua recolha.

Face ao grande volume de peças disponíveis e à descrição gráfica de todas elas, geralmente apresentadas com duas projecções e um ou mais cortes, optámos por inserir neste catálogo unicamente o número de registo geral, antecedido pela sigla identificadora do monumento, o tipo de artefacto, o material em que foi obtido, o quadrado de recolha e as referências tridimensionais de cada objecto.

Na ausência de todos, ou apenas de alguns elementos de localização e sempre que possível, adossaram-se à descrição mais algumas informações que possibilitam um melhor enquadramento da peça no espaço. Estas informações revestem-se de particular importância para os objectos provenientes, ou de terras em revolvimento, ou de violações antigas.

Mais de cinquenta por cento das peças catalogadas são provenientes de escavações efectuadas pelo extinto Grupo de Arqueologia de Castelo de Vide. Como noutro capítulo já referimos, destas escavações, para além dos materiais que aqui descrevemos, poucas informações existem. A observação dos monumentos espoliados e mais alguma informação oral obtida, juntamente com os esboços existentes da violação da anta da Tapada de Matos, foi possível, para alguns casos, identificar genericamente os espaços de recolha. Estas escavações, efectuadas nos primeiros anos da década de oitenta, atingiram unicamente o espaço interno dos monumentos. Pelas informações que possuímos nenhuma mamoa foi objecto de escavação.

Foi nossa preocupação ao divulgarmos pormenorizadamente a localização dos materiais catalogados facilitar futuras revisões à luz de novos conhecimentos. Raras são as colecções guardadas em museus ou depósitos que se encontrem acompanhadas de todas as referências de recolha. Os presentes materiais, ou se encontram já expostos, ou aguardam exposição para breve. Os registos que os acompanham são os próprios de cada museu e nem sempre contemplam todas as informações das fichas de campo, perdendo-se assim, e geralmente para sempre, o contexto da peça. Pretendeu-se, com o presente

catálogo, ultrapassar as monótonas descrições, geralmente inconsequentes, e fornecer, tanto quanto possível, informações que possibilitem o enquadramento da peça no seu contexto.

Neste catálogo incluem-se unicamente as peças inéditas e as que por nós foram parcialmente divulgadas em relatórios de escavação já publicados. Os outros materiais conhecidos na região em estudo foram já anteriormente publicados em obras de síntese e de grande divulgação, tornando-se desnecessária a sua recatologação.

Os materiais provenientes do Termo Municipal de Valência de Alcântara foram publicados por Primitiva Ramírez (Ramírez, 1988).

Os reduzidos espólios dos monumentos da freguesia de Montalvão recolhidos na década de cinquenta encontram-se descritos por Georg e Vera Leisner (Leisner e Leisner, 1959).

Todos os materiais do concelho de Marvão foram incluídos neste inventário com a excepção das quinze peças recolhidas durante a violação da anta da Tapada do Castelo e por nós já divulgados em 1981 (Dias e Oliveira, 1981). No Museu Nacional de Arqueologia guardam-se várias placas de xisto registadas como provenientes da Anta dos Vidais em Marvão e já publicadas por Georg e Vera Leisner (Leisner e Leisner, 1959). No mesmo estudo inscreve-se um vaso com mamilos, exposto no Museu de Elvas e catalogado como proveniente da anta do Porto da Espada. Como já anteriormente afirmámos, estas peças deverão estar incorrectamente inventariadas, atendendo a que não há qualquer notícia de antas na região do Porto da Espada e não se conhece também nenhuma anta com o nome de Vidais. Pelas informações que temos e pela correspondência existente entre António Maçãs e Leite de Vasconcelos ficamos a saber que esses materiais terão sido provavelmente recolhidos por Pedro Pena nas lapas de abrigo de Vidais e não numa anta denominada Vidais, desconhecendo-se assim o contexto da recolha.

O reduzido número de materiais do concelho de Castelo de Vide provenientes de escavações e violações anteriores aos anos oitenta do presente século e cuja origem exacta se desconhece já foram anteriormente descritos por Conceição Rodrigues (Rodrigues, 1975). Deste concelho e porque embora já publicados mas em texto policopiado e de difícil acesso (GACV, 1987), voltamos a descrever as placas e o báculo provenientes das antas do Alcogulo I e II, do Tapadão da Relva, Vale da Estrada, Olheiros e Tapada de Matos, apresentados pelos membros do Grupo de Arqueologia de Castelo de Vide ao 1º Encontro de História Regional e Local do Distrito de Portalegre.

Os materiais provenientes de monumentos do concelho de Marvão que neste catálogo se descrevem encontram-se depositados e praticamente todos expostos no Museu Municipal de Marvão.

As peças recolhidas em monumentos do concelho de Castelo de Vide incluídas neste catálogo encontram-se guardadas no depósito de materiais arqueológicos da Secção de Arqueologia da Câmara Municipal de Castelo de Vide.

Na Câmara Municipal de Nisa entregámos os materiais recolhidos nas antas Lomba da Barca e Fonte da Pipa. Os materiais recolhidos na anta da Nave do Padre Santo

foram entregues para exposição no núcleo museológico da Santa Casa da Misericórdia de Nisa, por indicação da respectiva Câmara Municipal.

2.

Neste catálogo incluem-se os desenhos, com duas projecções e um a dois cortes, das peças arqueológicas inéditas provenientes dos monumentos da área em estudo. Apenas não são inéditos os materiais já divulgados pelo GACV (GACV, 1987) e os por nós publicados em relatórios de escavação (Oliveira, 1990; 1992).

Embora tentássemos uniformizar critérios de desenho, verificam-se neste *corpus* algumas, mas pouco significativas, diferenças na técnica de tintagem e projecção das peças. Estas variantes resultam, devido aos diferentes desenhadores que conosco colaboraram e ao grande número de materiais reproduzidos. Embora a maior parte dos desenhos tivessem sido por nós elaborados, socorremo-nos também, e sobretudo para os materiais provenientes de escavações antigas do concelho de Castelo de Vide, dos já anteriormente efectuados pelos desenhadores da Câmara Municipal de Castelo de Vide, que nos facultou a sua utilização.

A não existência de critérios universalmente aceites para a projecção e tintagem das peças arqueológicas, a técnica e a "arte" de cada desenhador transparece no trabalho final. Esta diversidade reflecte-se, naturalmente, num trabalho como o presente onde mil quinhentas e oitenta e sete peças foram ilustradas por cinco desenhadores. Durante o desenho de tão grande número de objectos, ao longo de vários anos (desenhos efectuados entre 1984 e 1993), aprofundou-se a técnica e procuraram-se outras soluções na apresentação final, reflectindo-se, naturalmente, num trabalho de síntese como o presente. Esta diversidade é mais notória nos materiais líticos, onde nem sempre os critérios de projecção foram idênticos. Nas cerâmicas existe maior uniformidade. Efectuou-se a recuperação da forma completa do recipiente sempre que o mesmo se encontrava inteiro ou quando, pelo menos, mais de metade da peça se encontrava unida ou possibilitava colagem desde que da base ao lábio existisse continuidade. Quando o fragmento possibilitava a recuperação da forma, mas era inferior a metade da peça, essa porção foi projectada directamente, sem orientação, sobre o corte devidamente orientado, evidenciando-se assim as reais dimensões do fragmento. Quando o fragmento era demasiado pequeno inviabilizando a recuperação do diâmetro do bordo ou do bojo, mas possibilitava a sua orientação, ao lado do corte procedeu-se à sua projecção directa, indicando-se, assim, também as dimensões reais do fragmento. Quando alguma peça, cerâmica ou não, apresentava alguma particularidade de maior interesse procedemos a mais projecções, rolagens ou cortes especiais.

No presente *corpus* encontram-se desenhos por nós efectuados, pelo dr. Manuel Calado, quando nosso aluno na Universidade de Évora, e pelos desenhadores da Secção de Arqueologia da Câmara Municipal de Castelo de Vide, senhores António Pita, Bica Penhasco e João Magusto.

3.

O presente catálogo organiza-se por concelhos. Em cada concelho as sepulturas megalíticas apresentam-se por ordem alfabética. O único menir que forneceu material desenhável foi o do Carvalho situado no concelho de Castelo de Vide. Estes materiais encontram-se registados depois dos recolhidos nas sepulturas megalíticas deste concelho.

Na identificação das peças utilizámos as seguintes abreviaturas, sendo esta também a ordem de apresentação dos materiais incluídos neste catálogo.

#### **Concelho de Marvão**

**BC** - Anta da Bola da Cera

**C** - Anta da Cabeçuda

**AC** - Anta das Castelhanas

**FB** - Anta da Figueira Branca

**AP** - Anta dos Pombais

#### **Concelho de Castelo de Vide**

**AI** - Anta I do Alcogulo

**AII** - Anta II do Alcogulo

**CE** - Anta I do Cerejeiro

**CI** - Anta I dos Coureleiros

**CII** - Anta II dos Coureleiros

**CIII** - Anta III dos Coureleiros

**CIV** - Anta IV dos Coureleiros

**G** - Anta do Galhardo

**O** - Anta dos Olheiros

**PA** - Anta do Pai Anes

**PV** - Anta do Porto Aivado

**S** - Anta do Sobral

**TM** - Anta da Tapada de Matos

**TR** - Anta do Tapadão da Relva

**AVE** - Anta do Vale da Estrada

**MC** - Menir do Carvalho

#### **Concelho de Nisa**

**FP** - Anta da Fonte da Pipa

**LB** - Anta da Lomba da Barca

**PS** - Anta da Nave do Padre Santo

## DESENHOS DOS MATERIAIS



ANTA  
da  
**BOLA DA CERA**

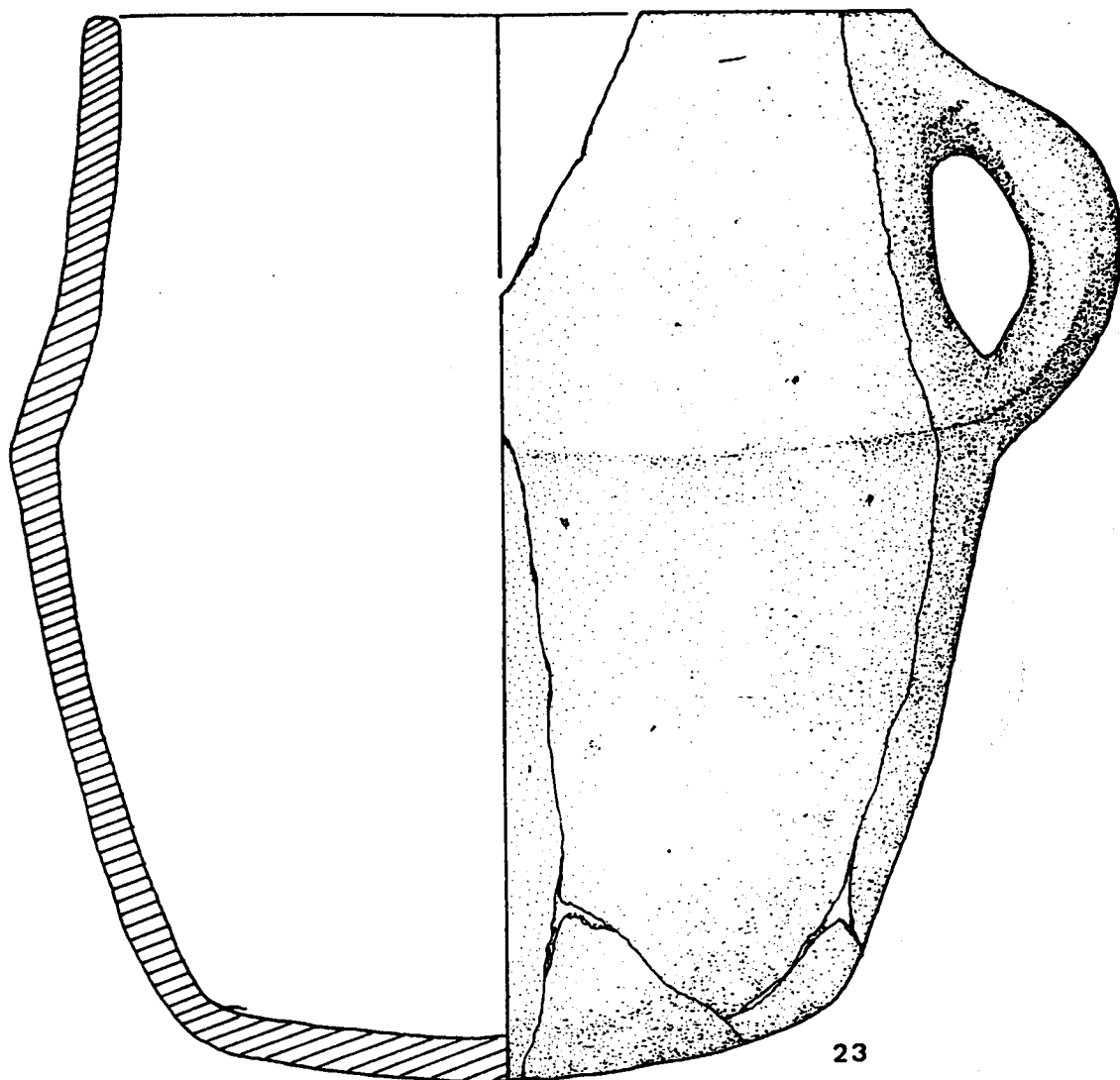

23

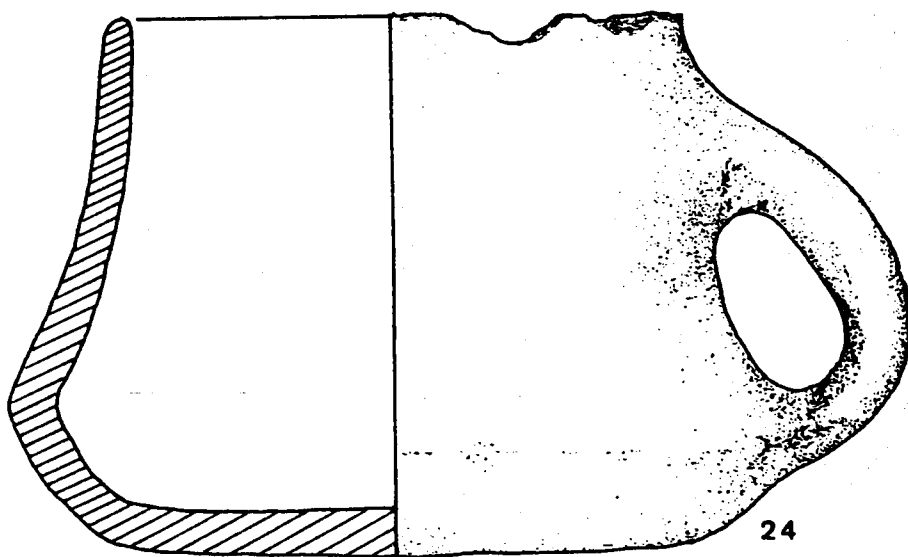

24



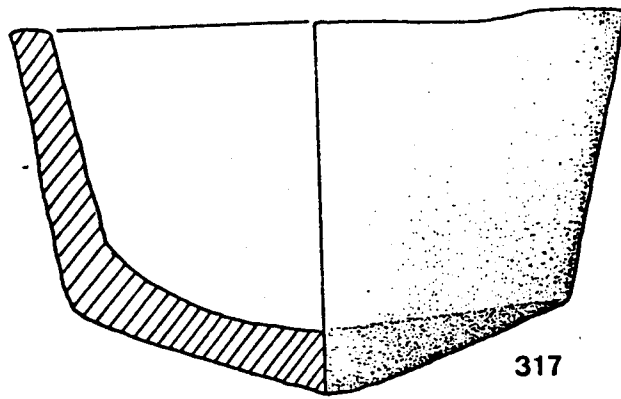

317

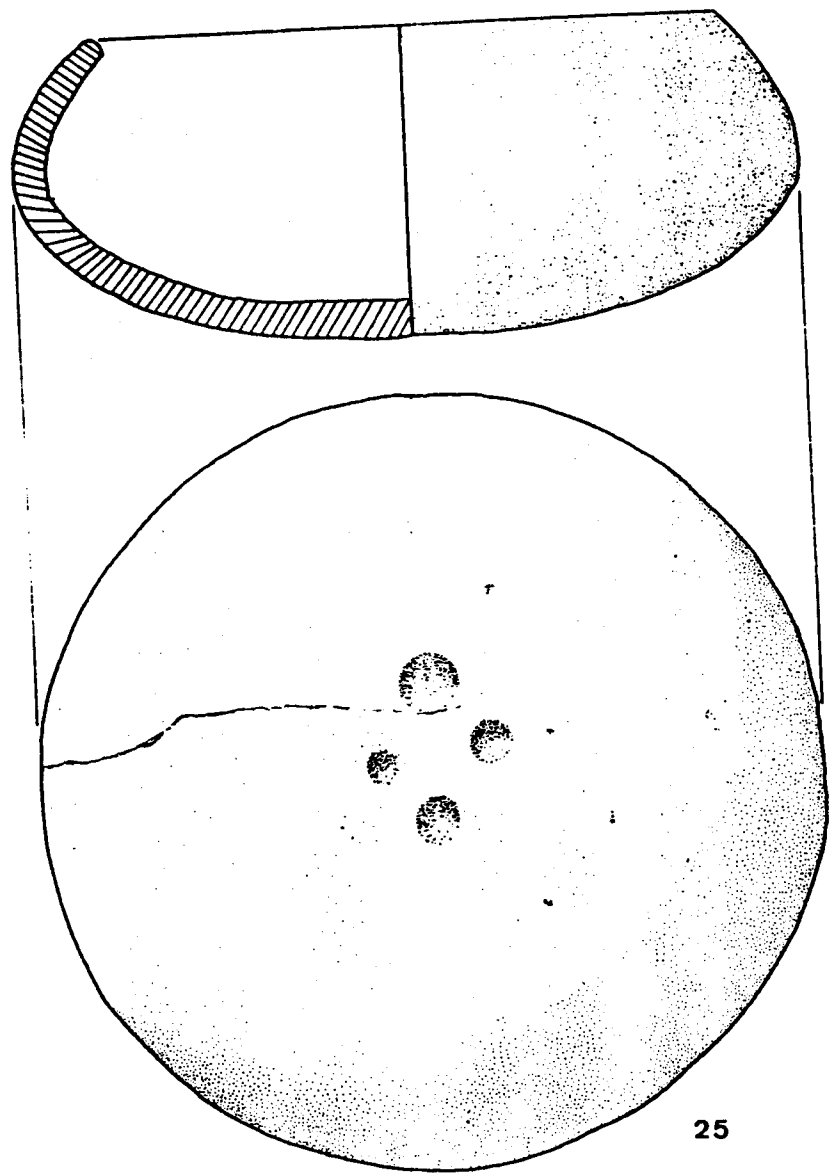

25



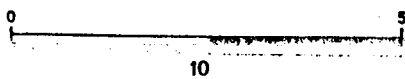
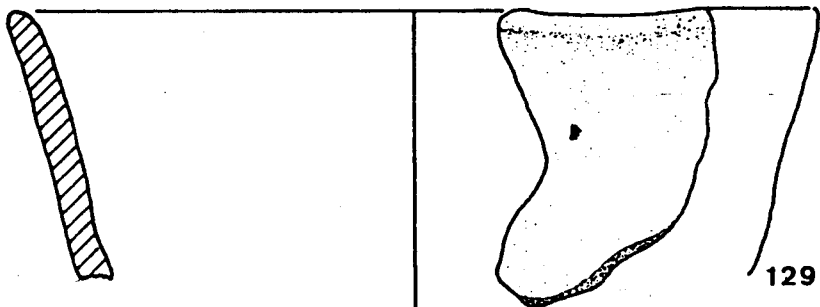
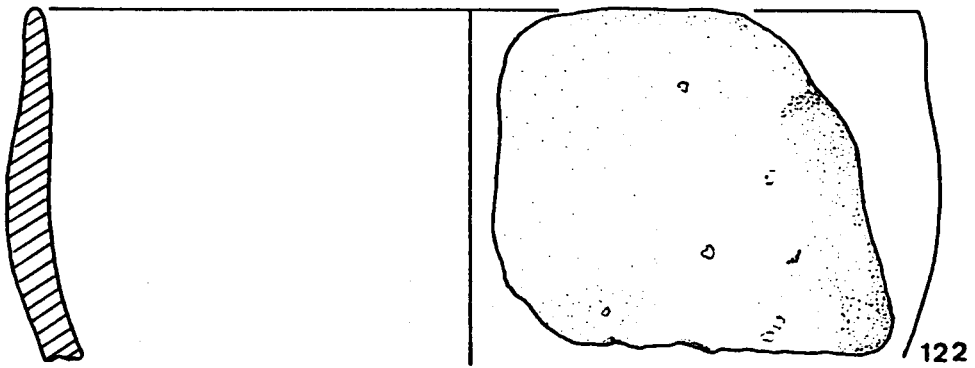
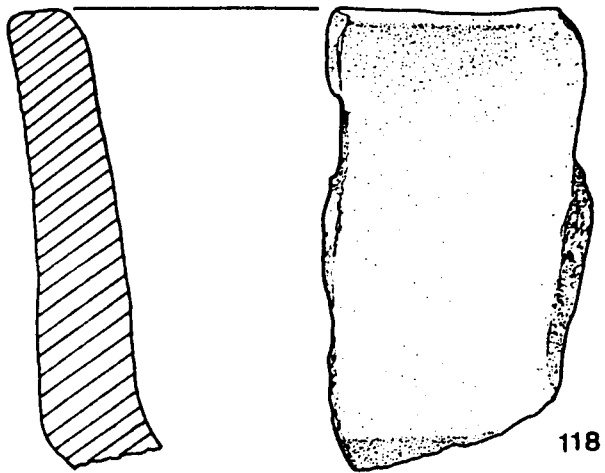
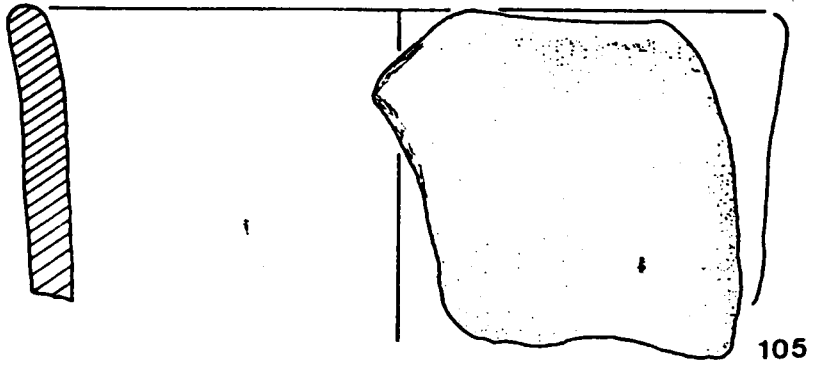

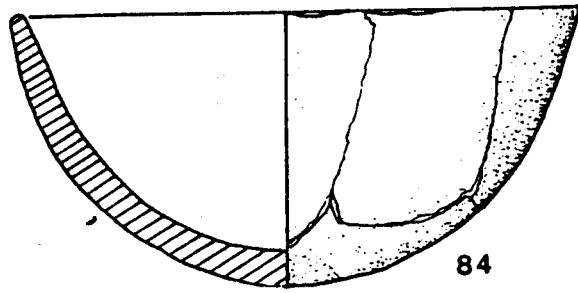

84

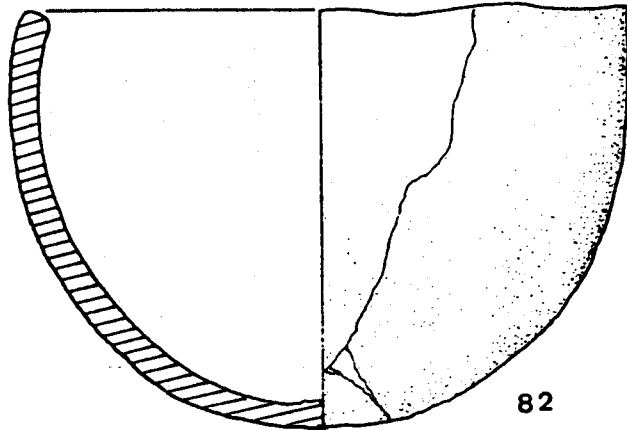

82

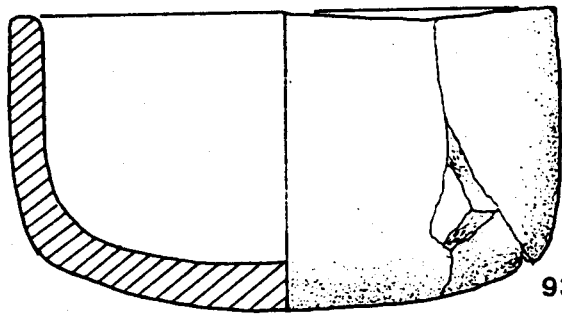

93

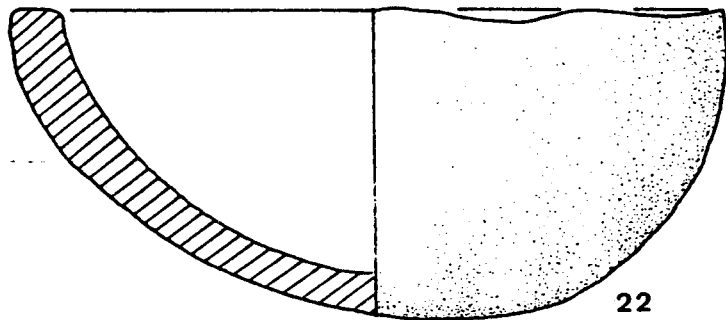

22



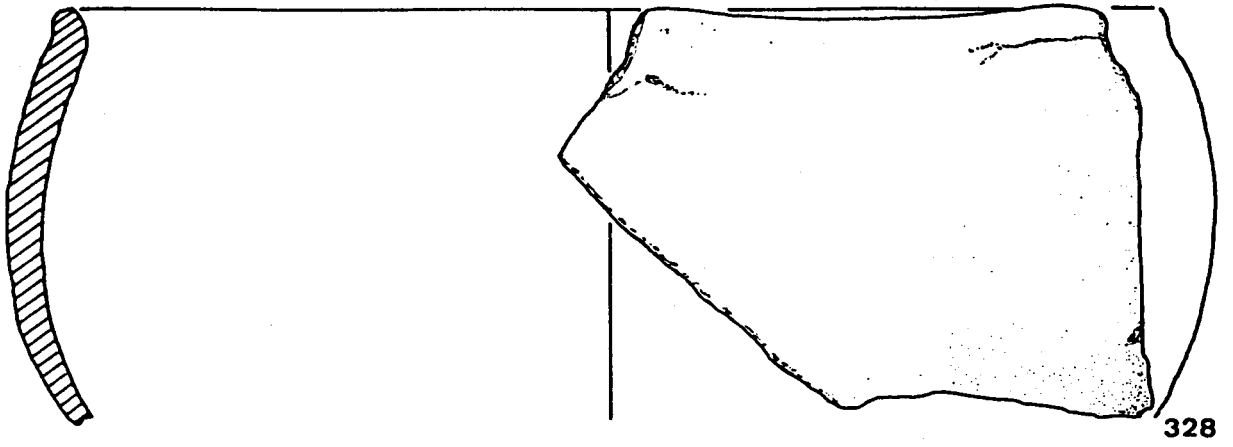

328

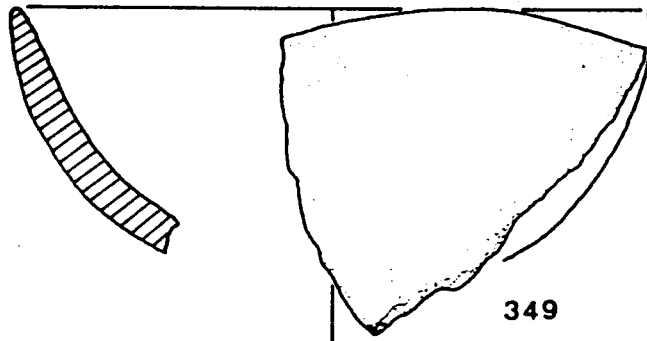

349

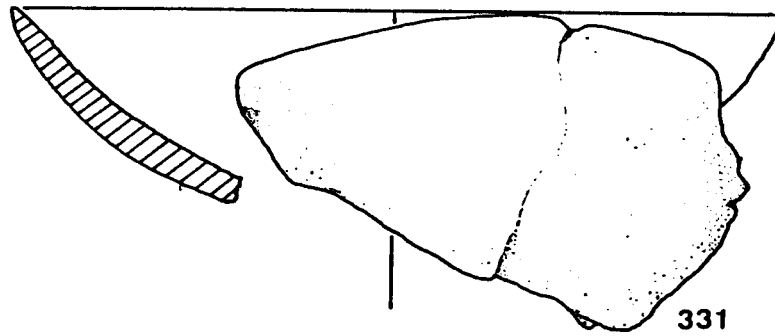

331

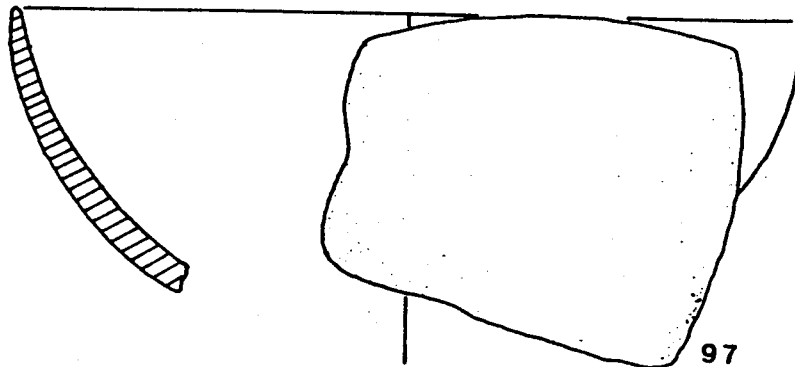

97

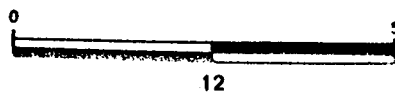

12

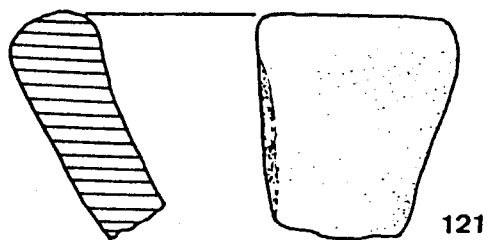
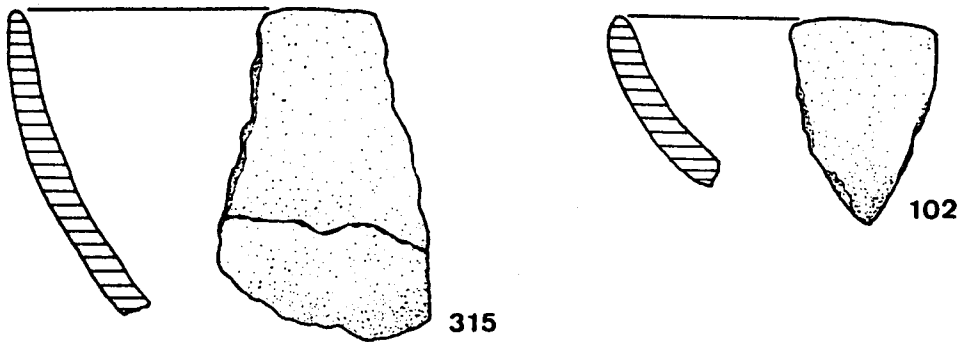
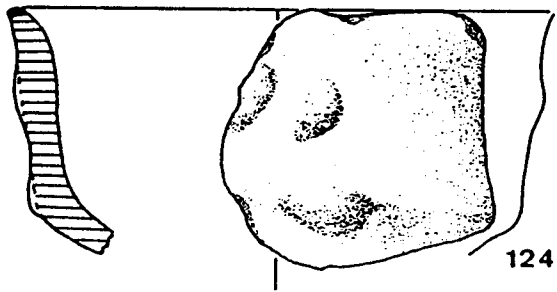
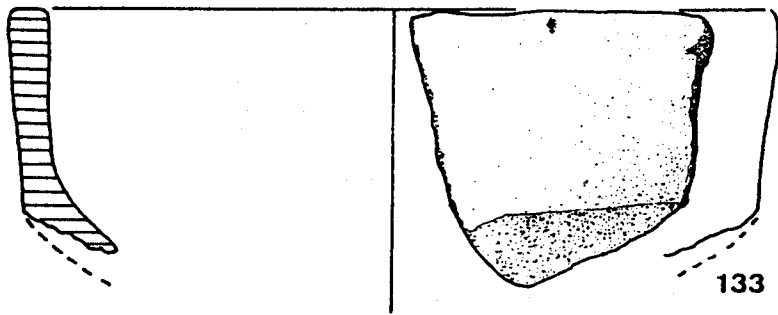
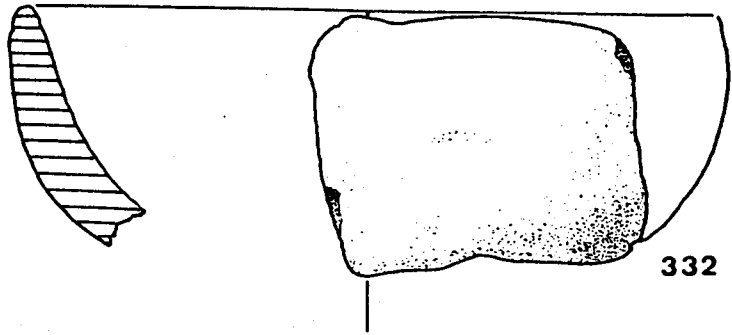

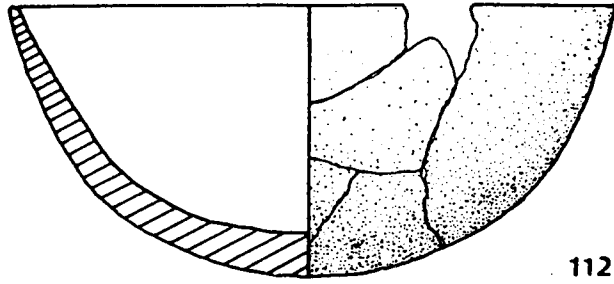

112

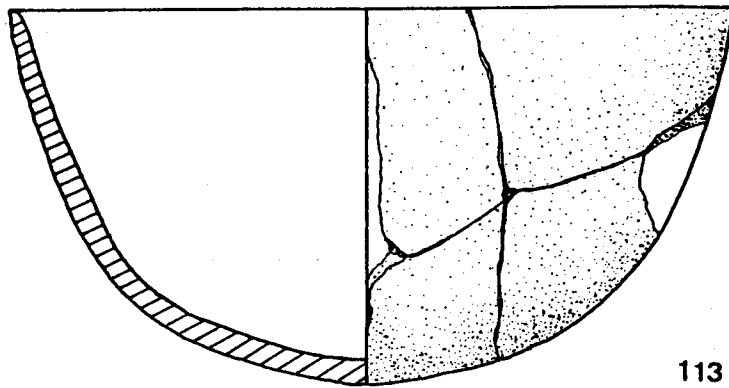

113

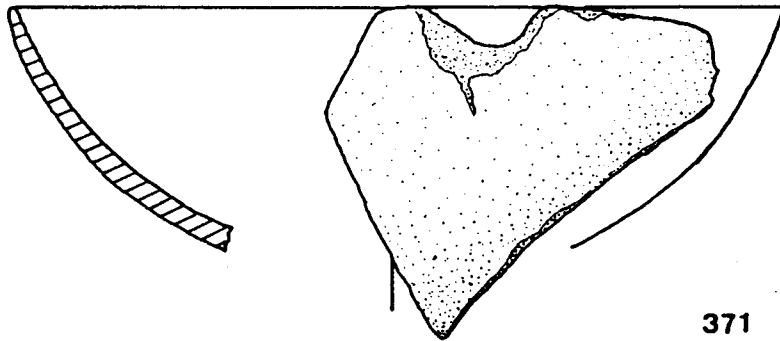

371

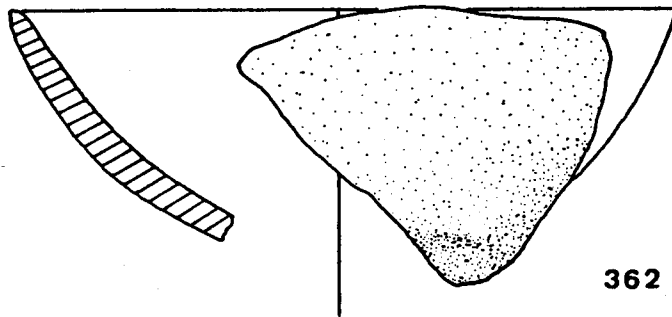

362





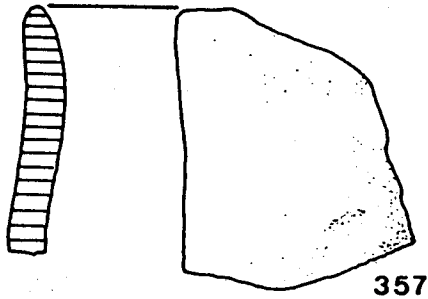

357

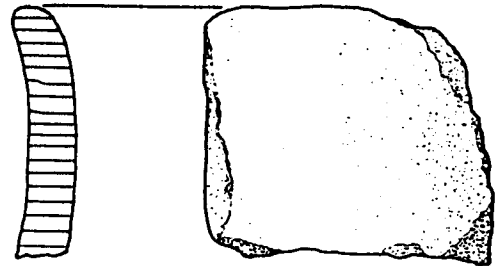

120

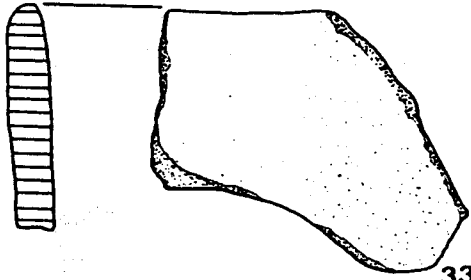

339

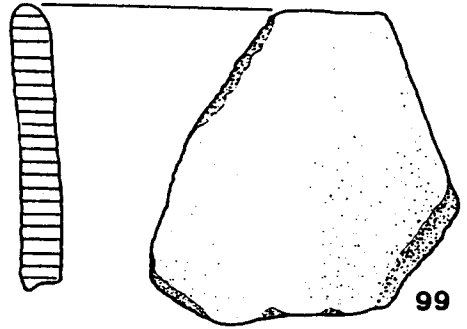

99

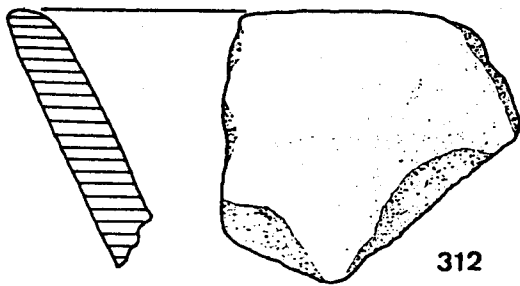

312

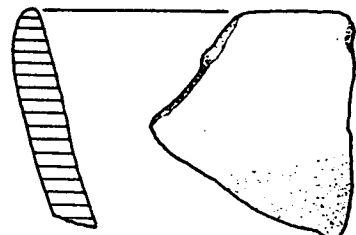

358

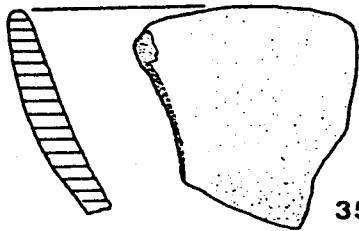

359

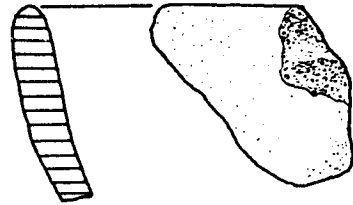

337

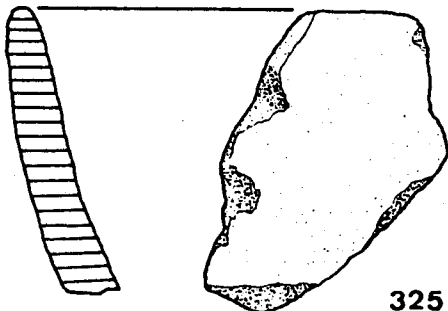

325

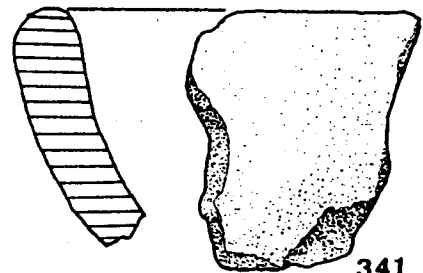

341

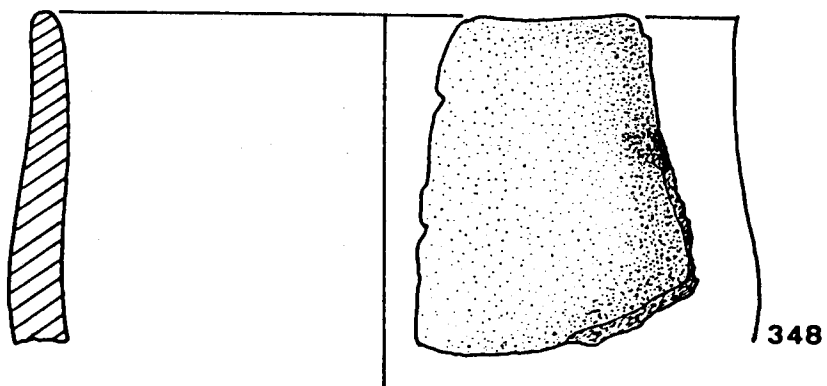
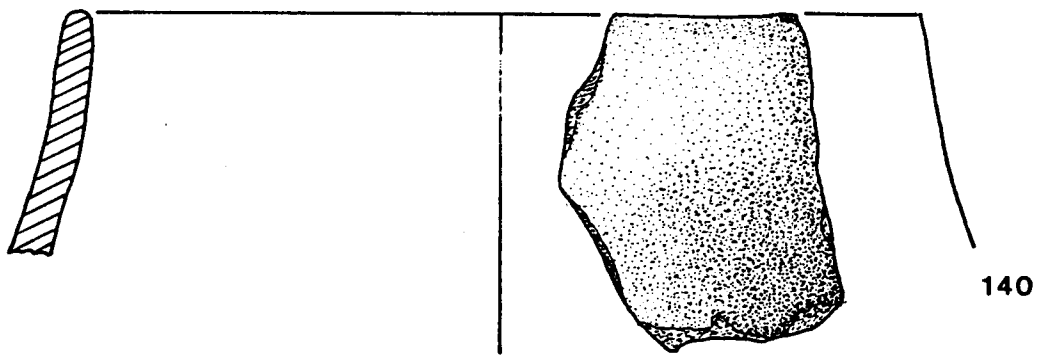
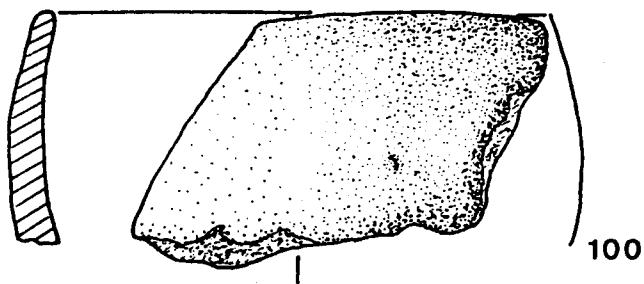
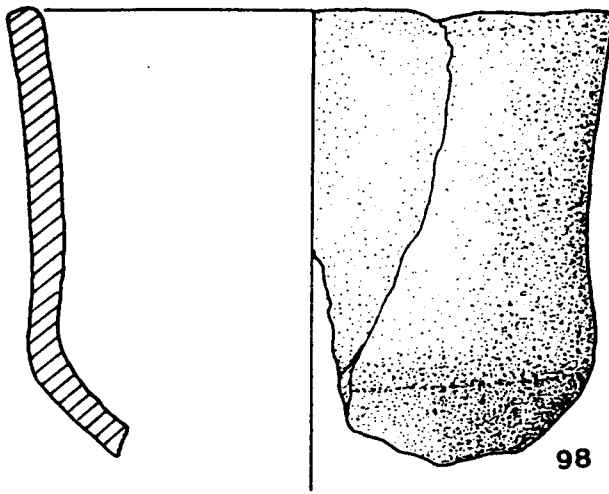

0 16 5

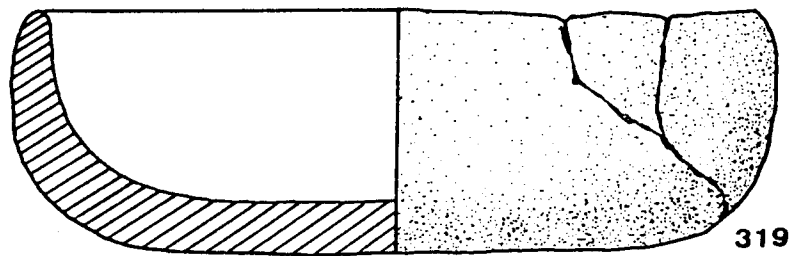
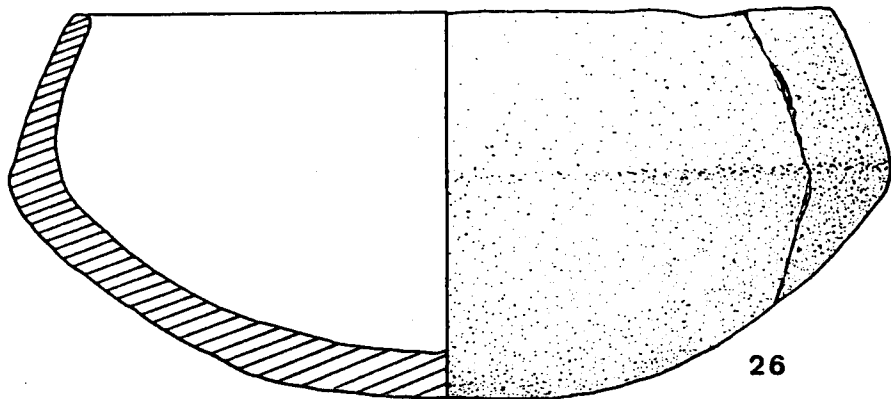
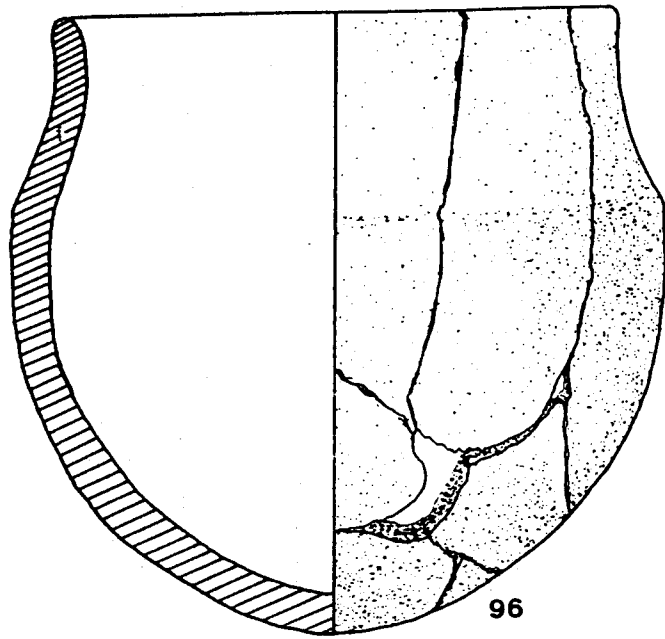

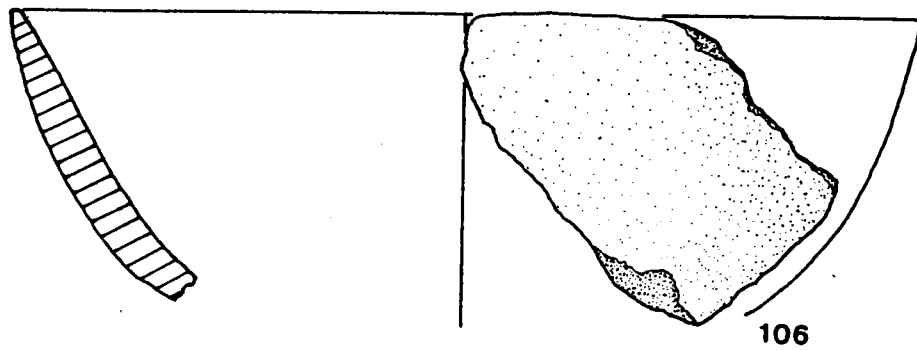
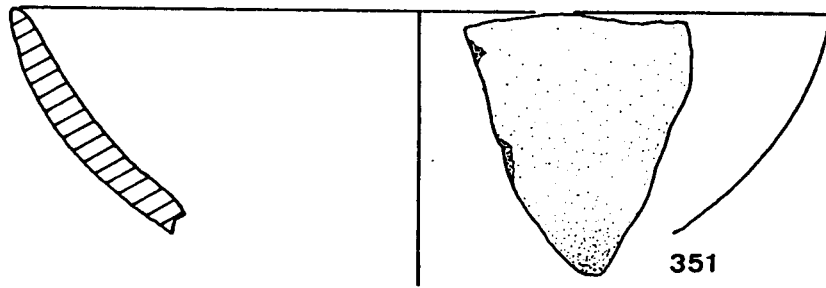
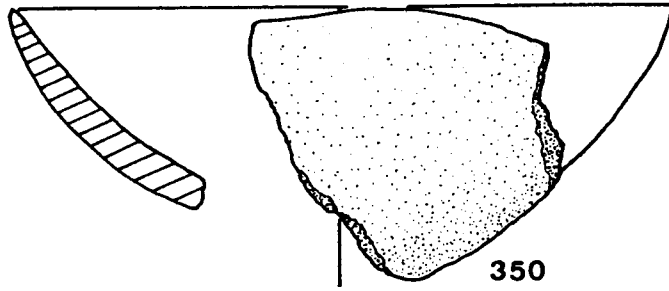
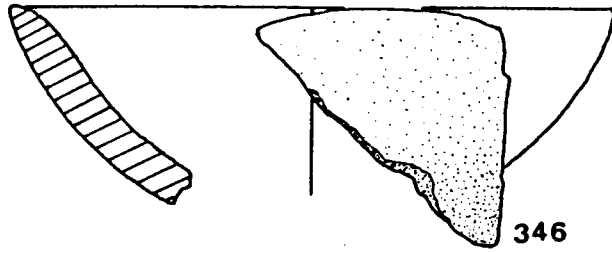

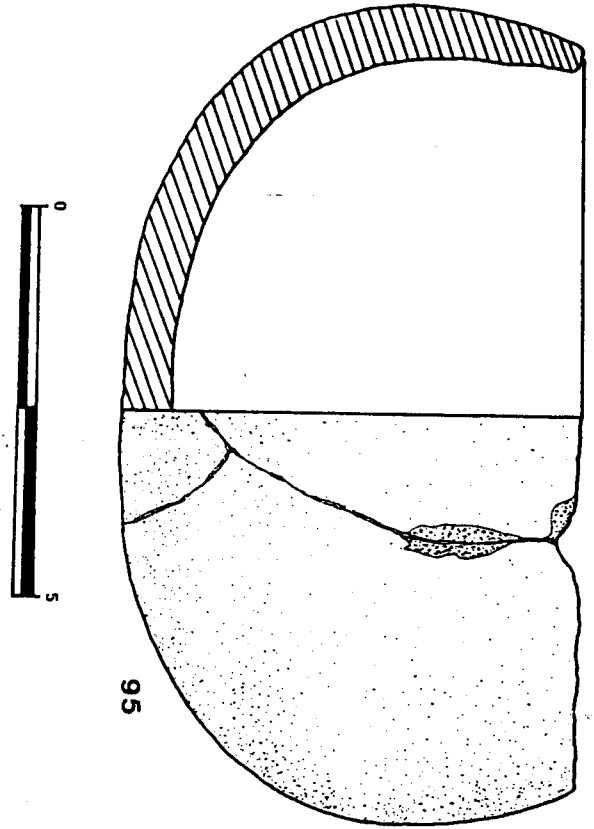
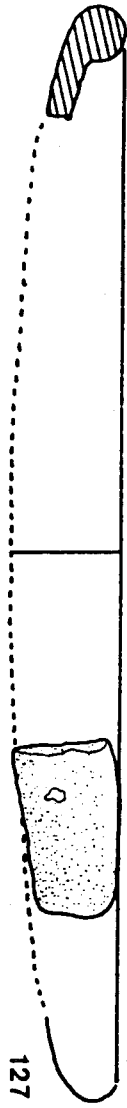
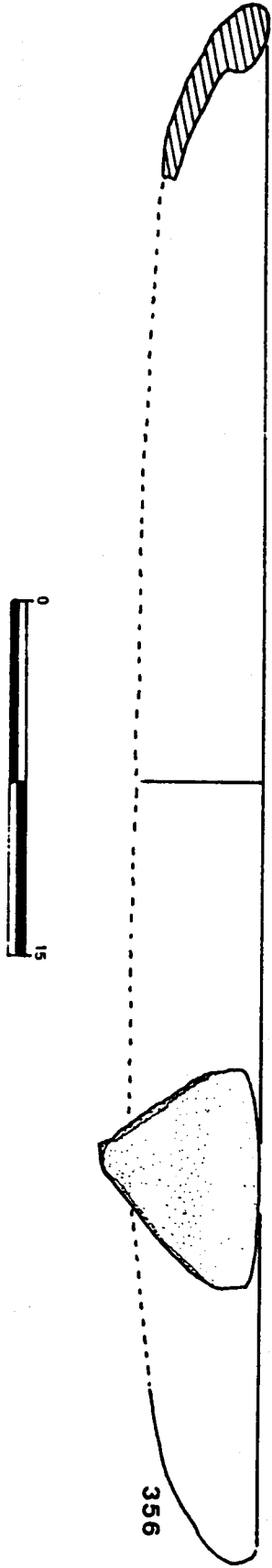

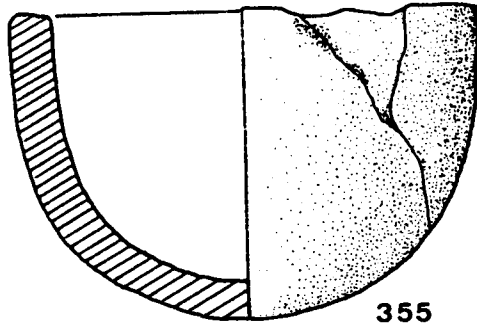

355

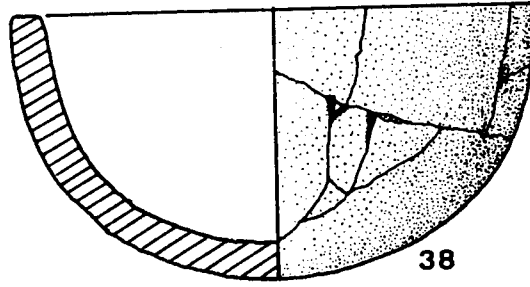

38

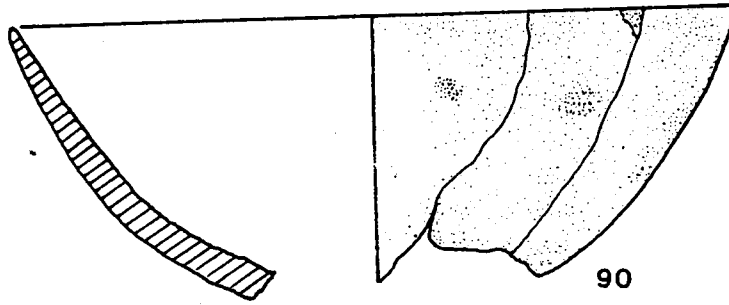

90

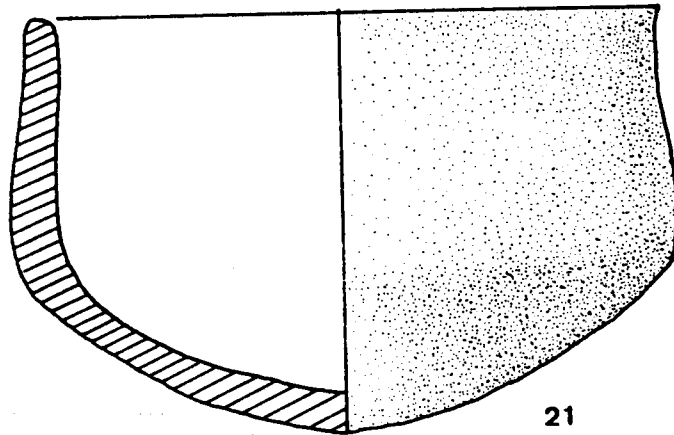

21



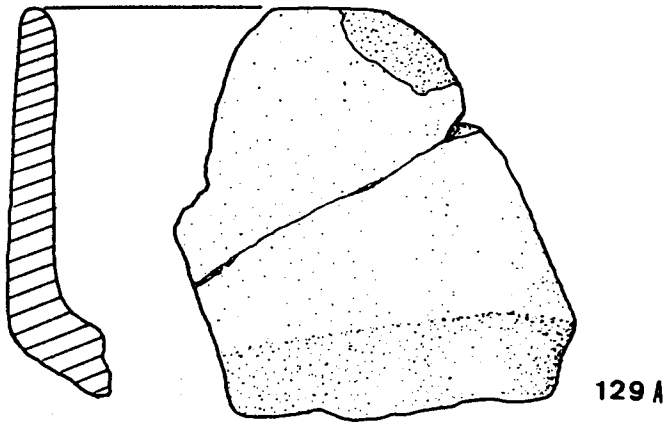
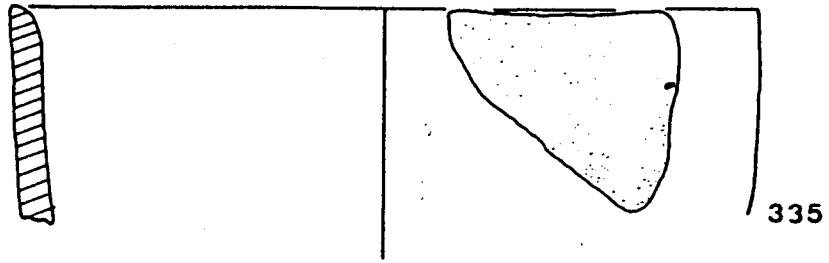
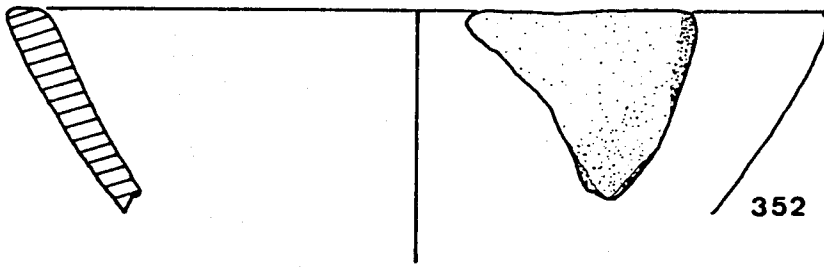
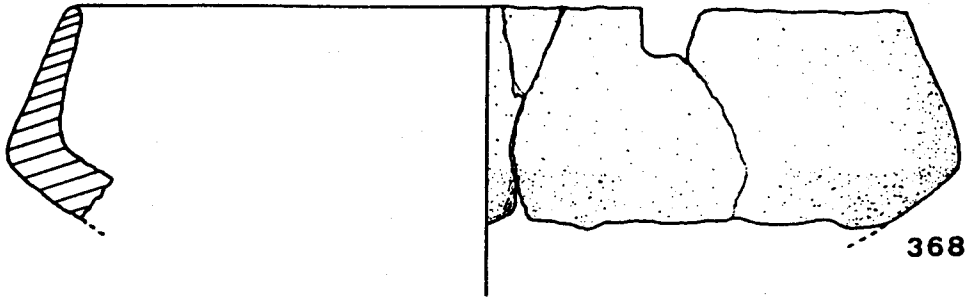

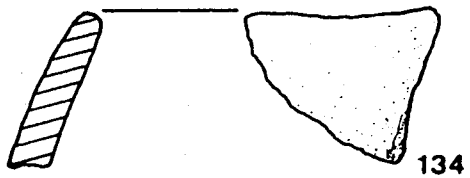
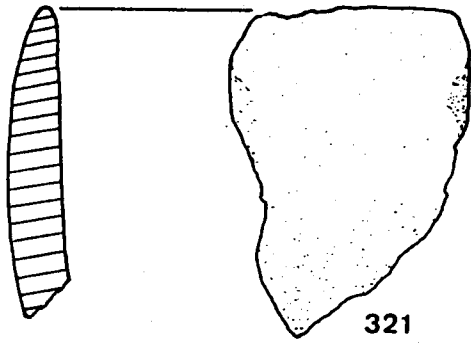
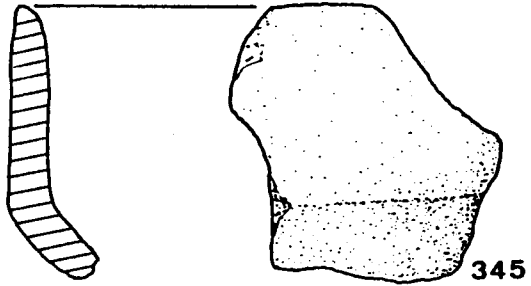
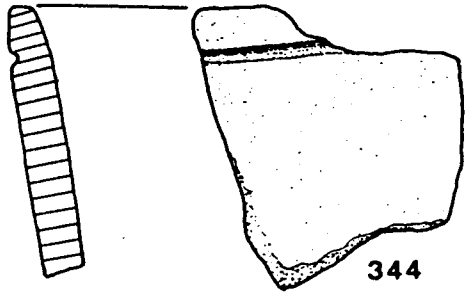



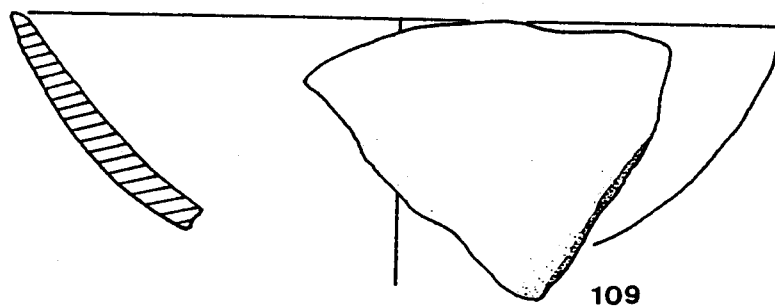
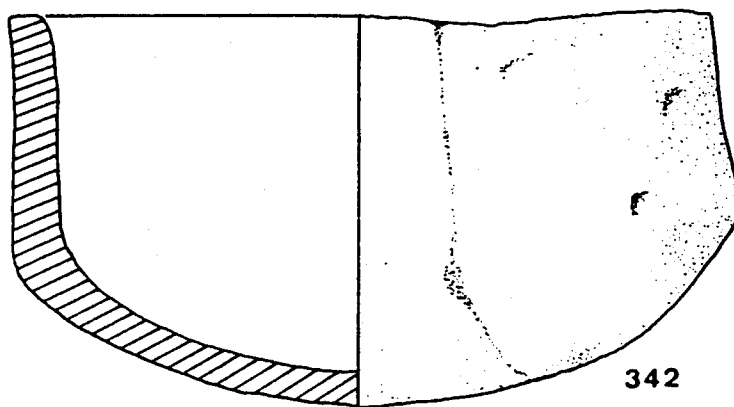
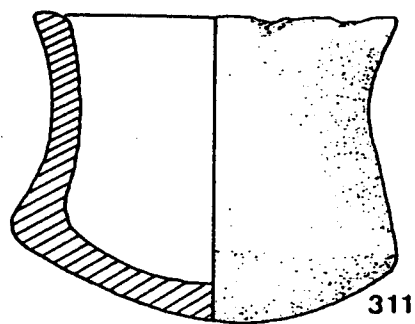

135

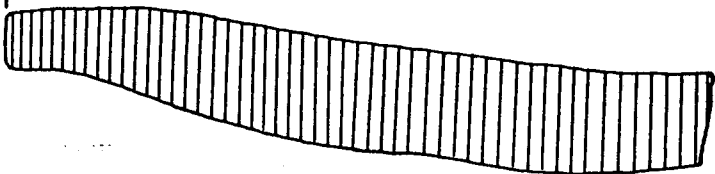
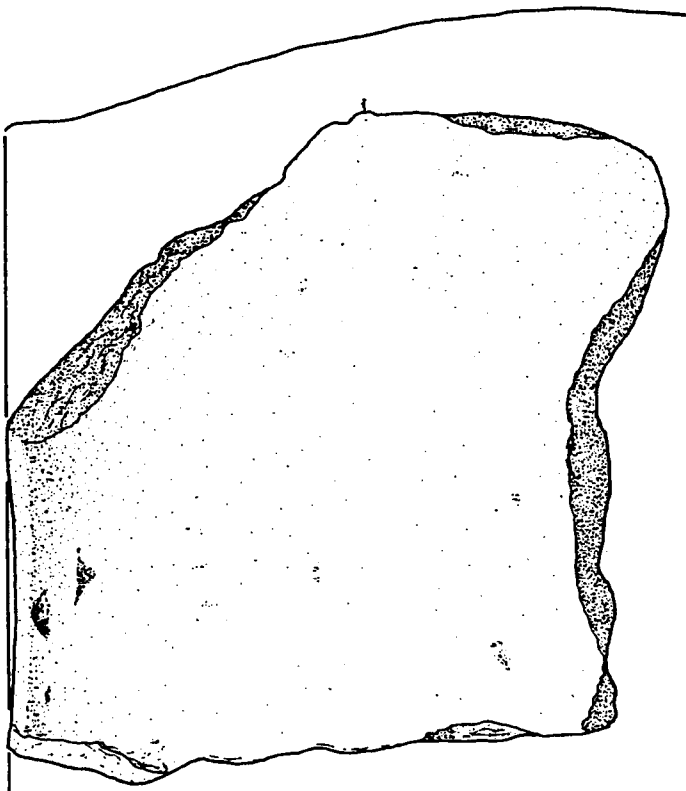

24



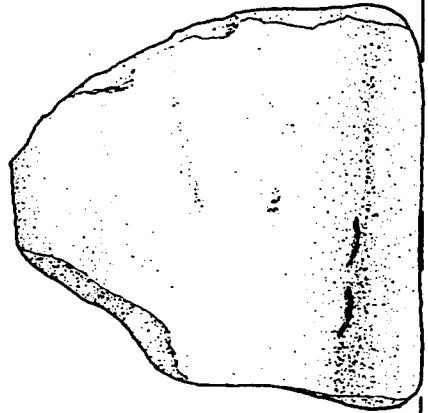
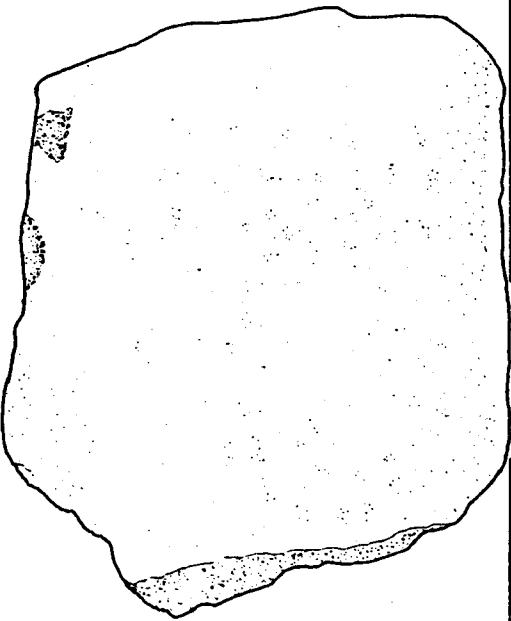
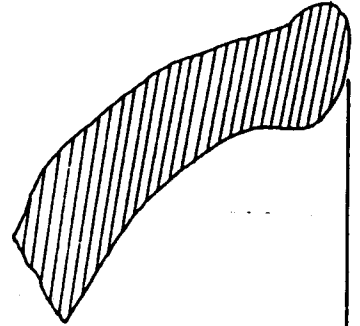
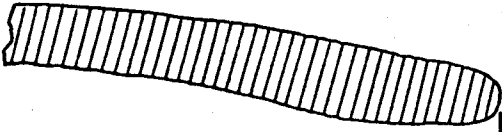

324

130

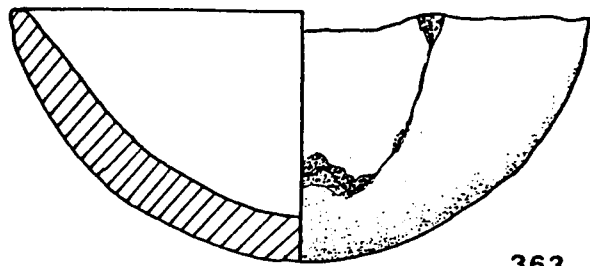

363

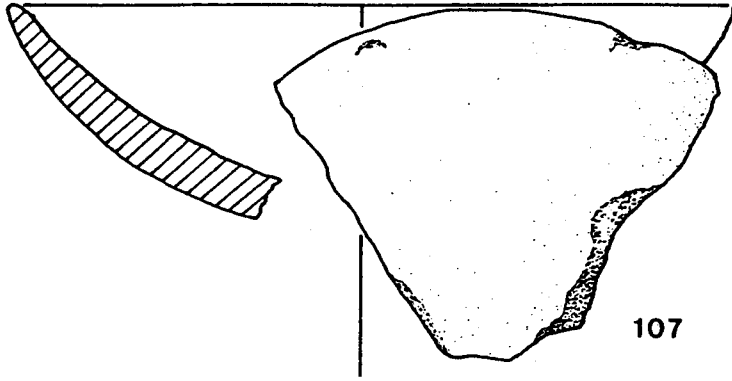

107

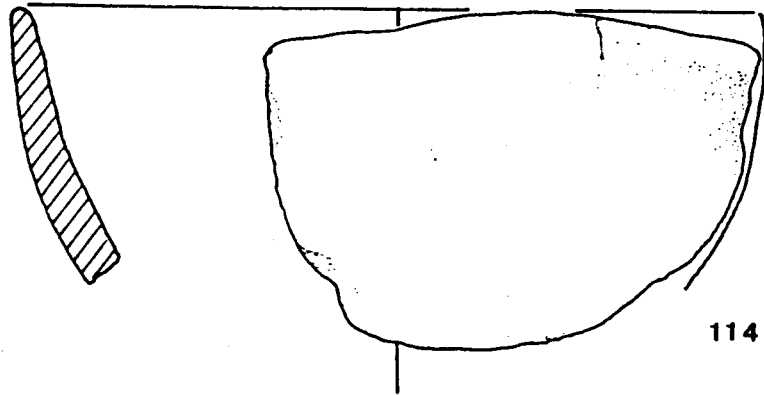

114

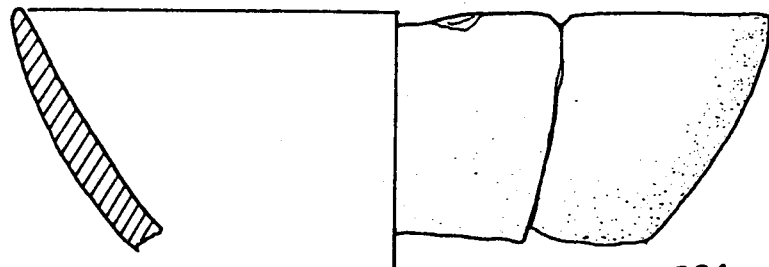

364



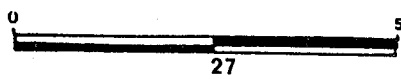
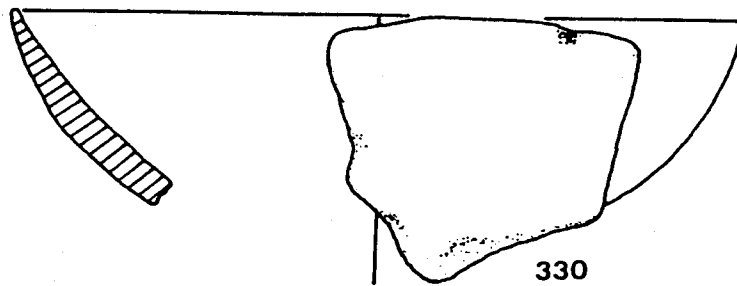
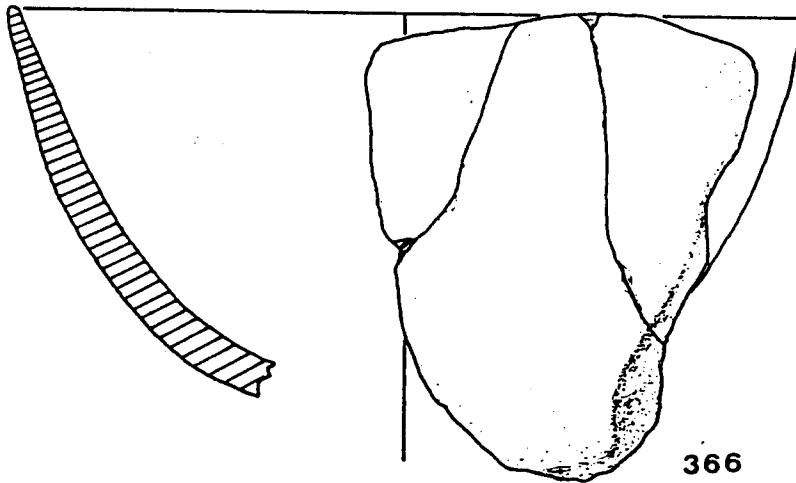
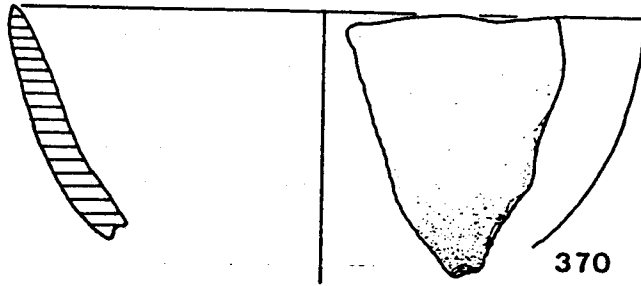
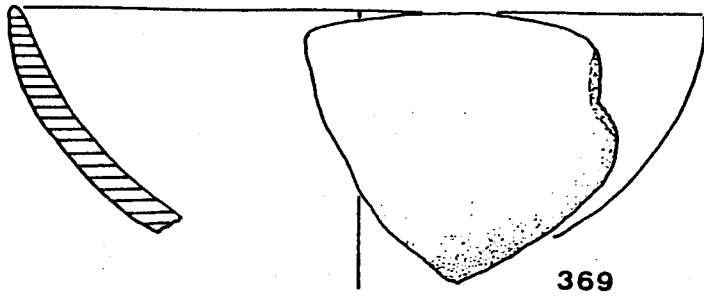

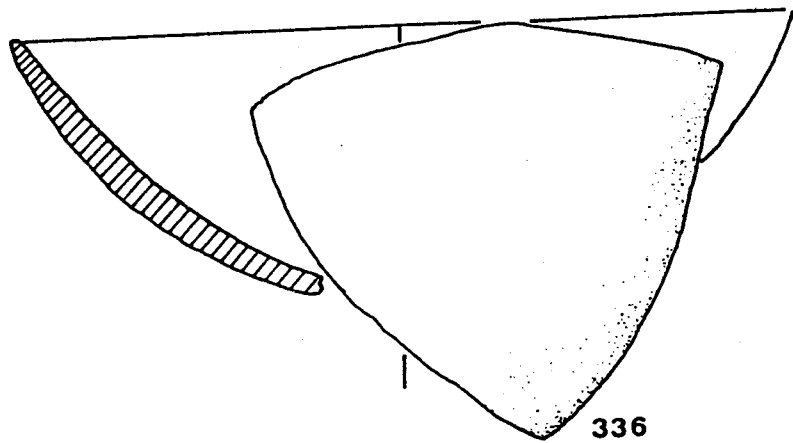
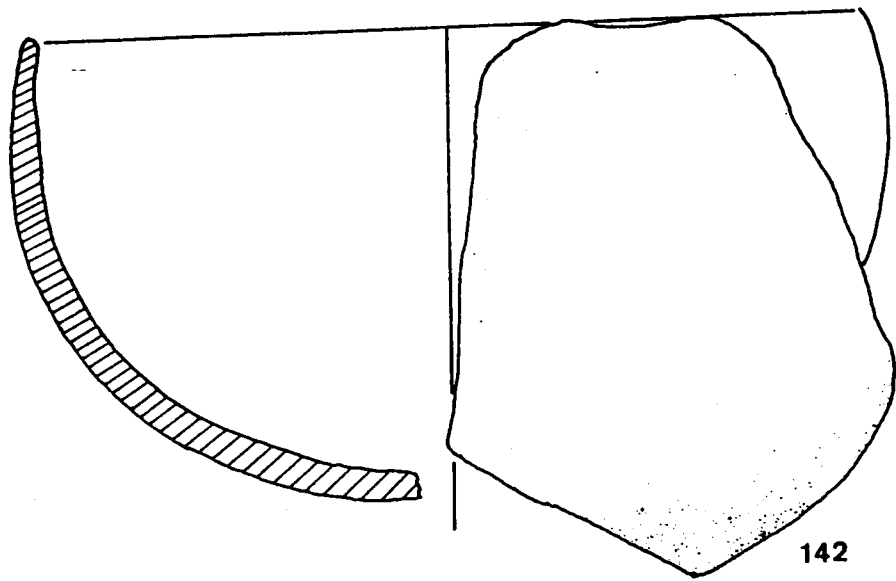
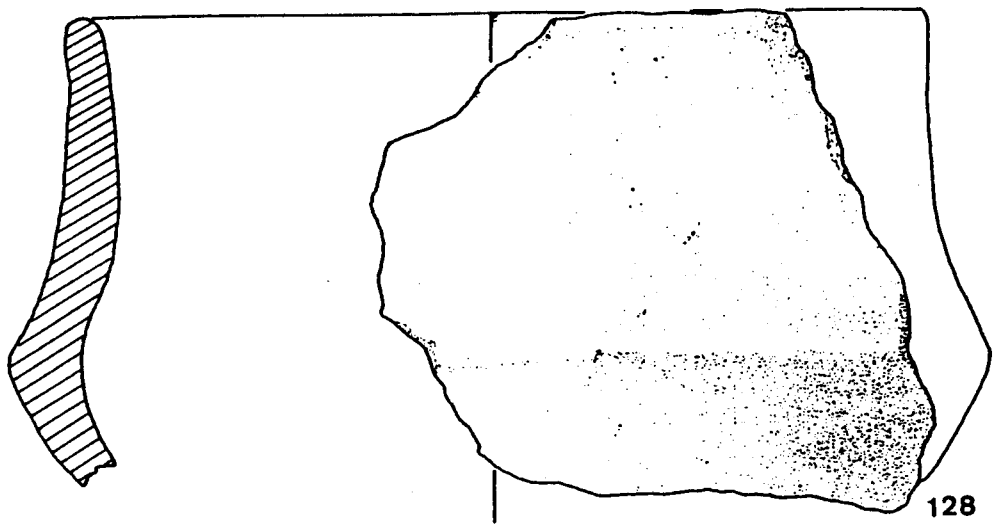

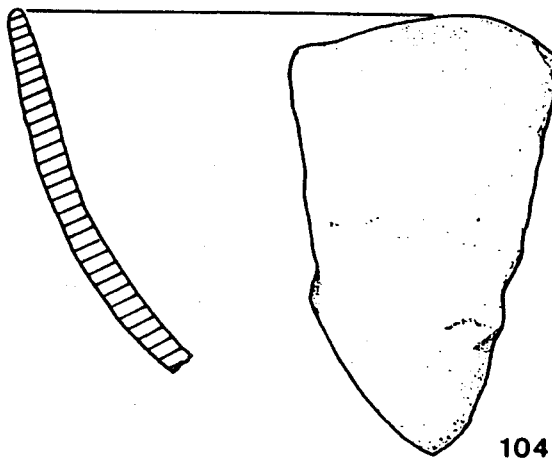
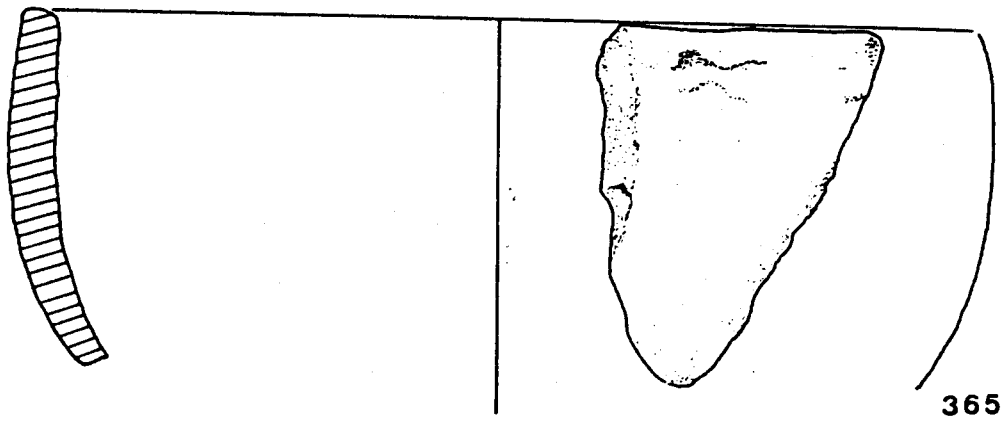
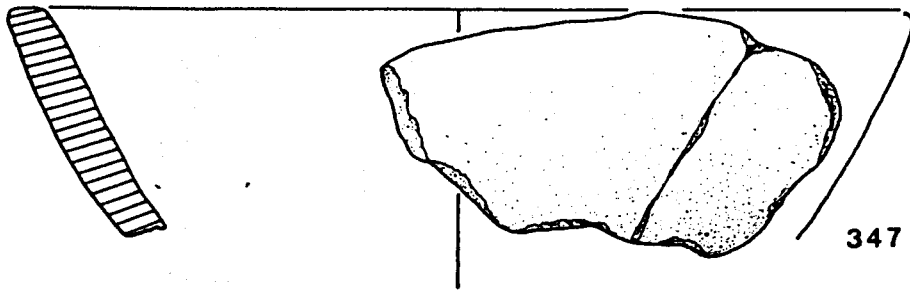
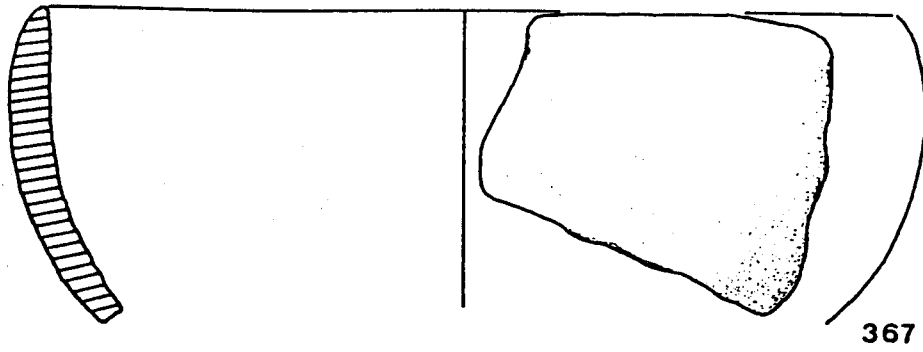

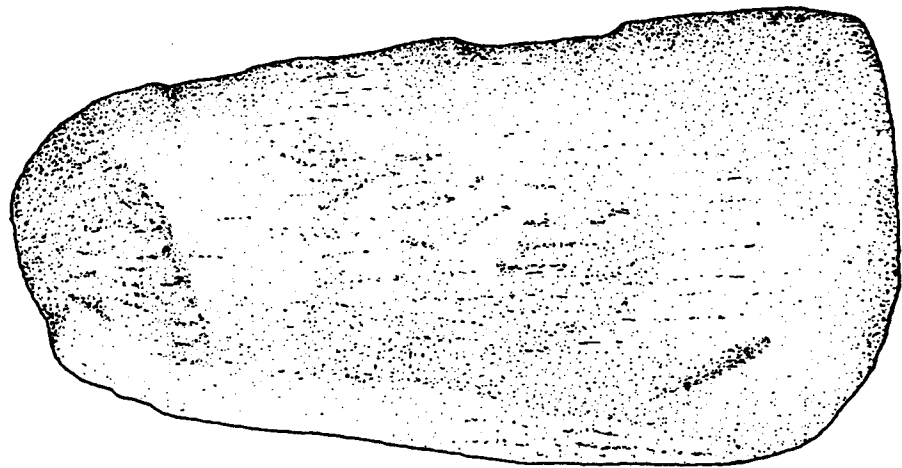

68

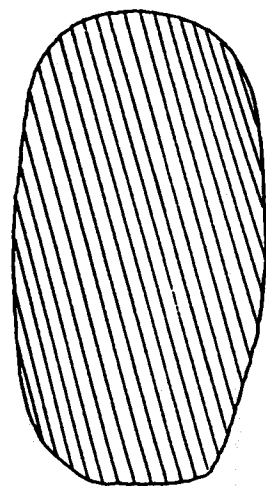
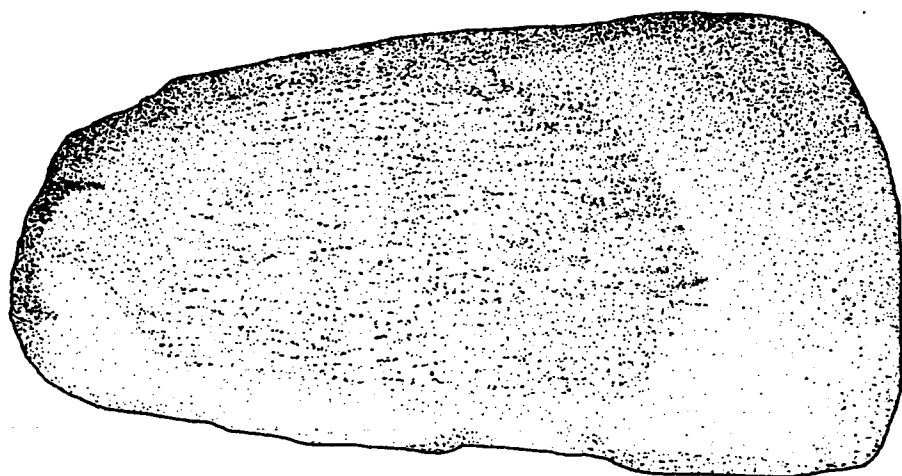
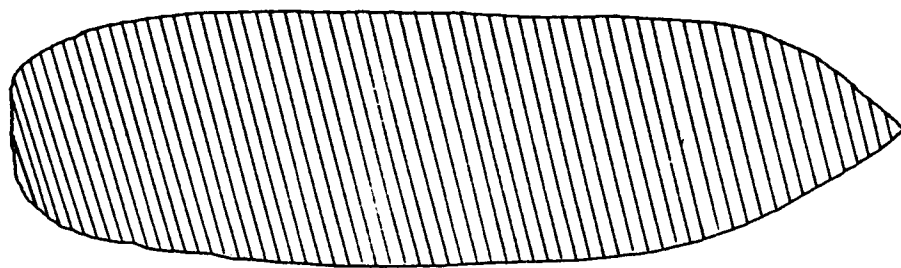



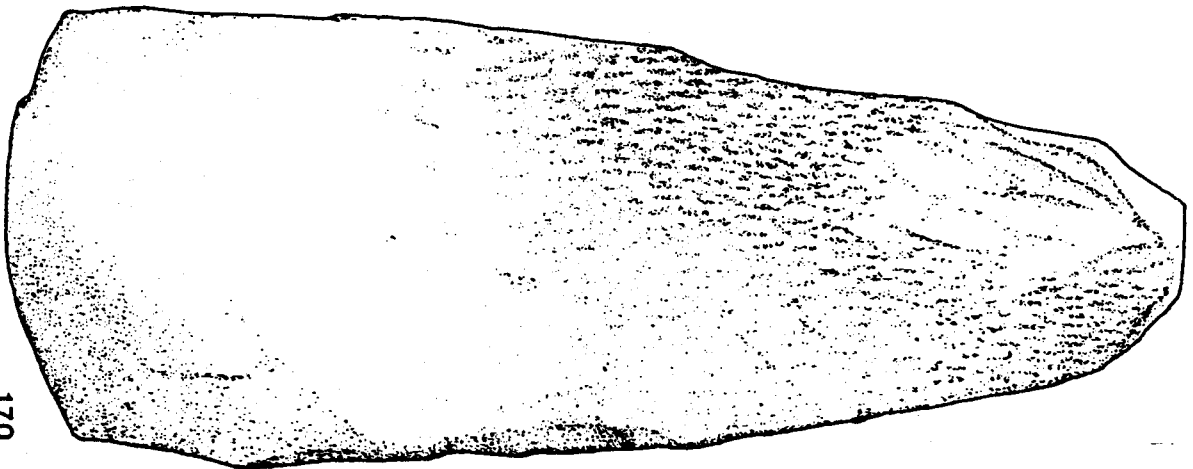
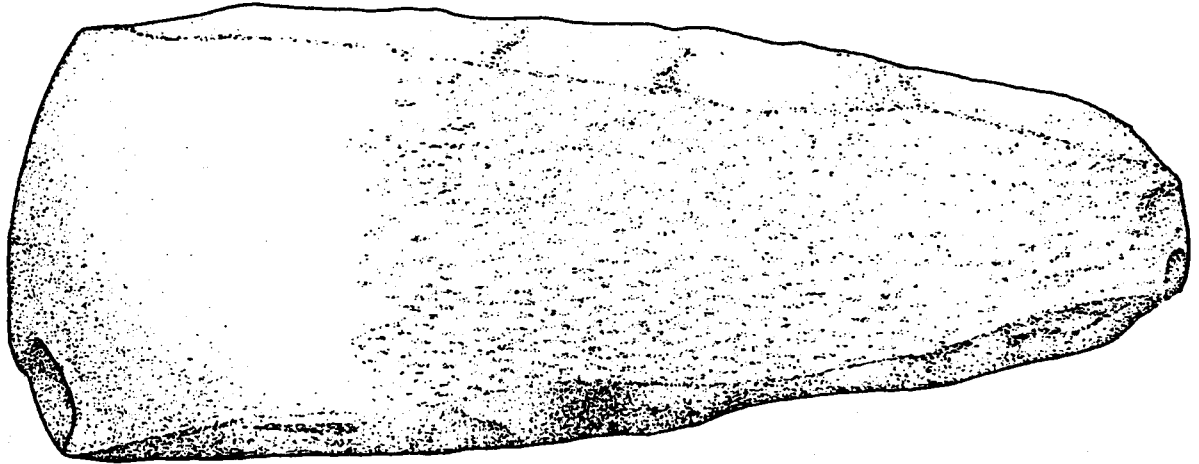

170

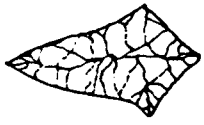

44

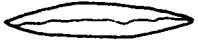

361



224

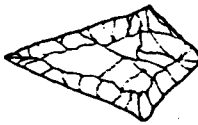
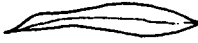

221



172

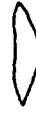
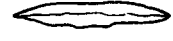

36

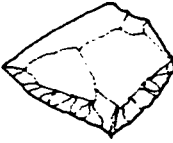
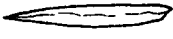

289

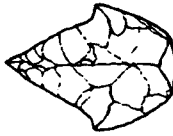

231

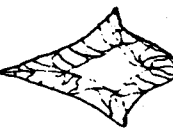

32



372



373

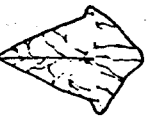
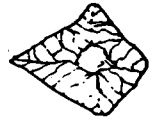

238



277

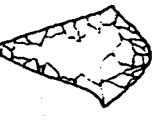
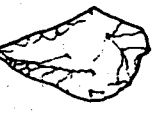

260

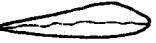

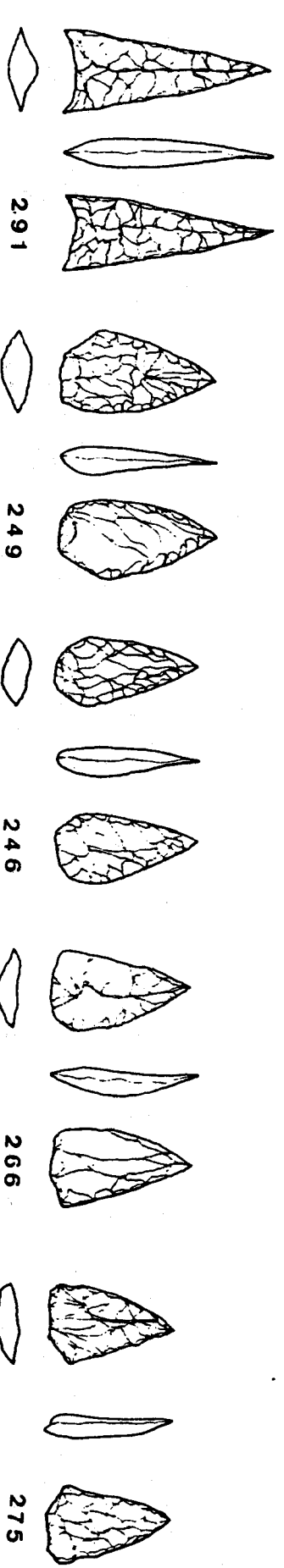
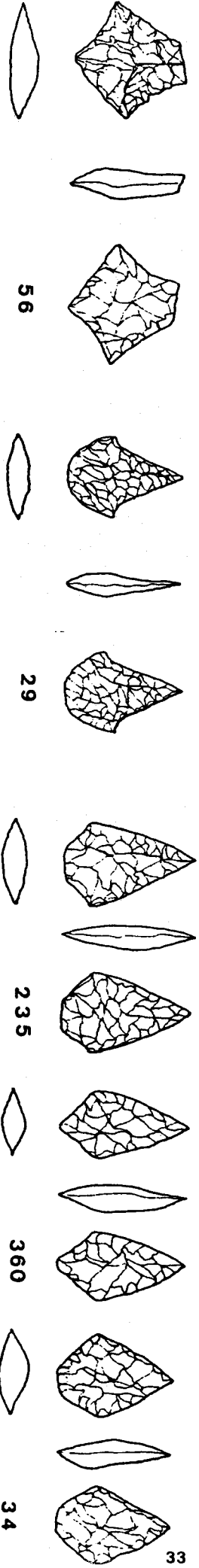
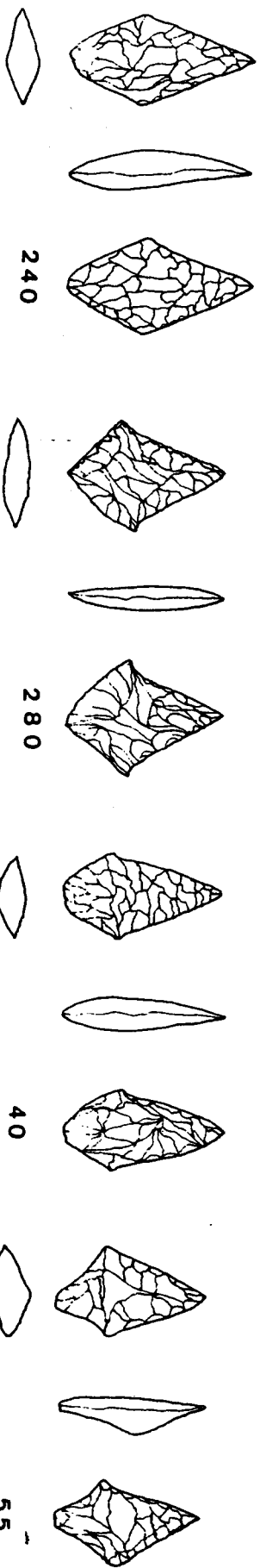

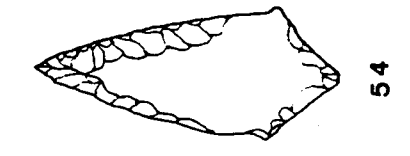

54

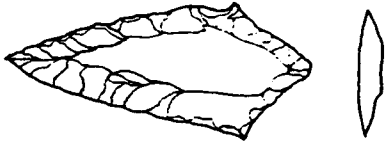
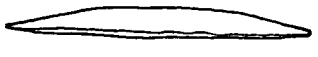

257

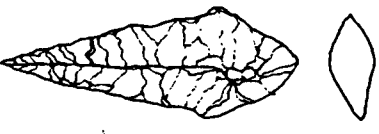
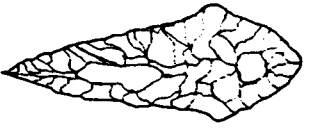

230

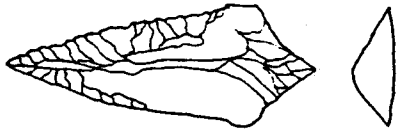
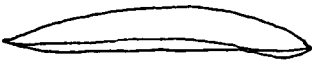
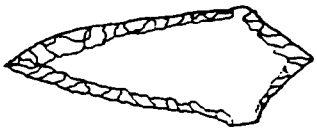

219

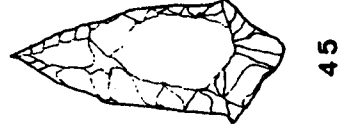
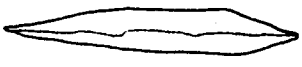
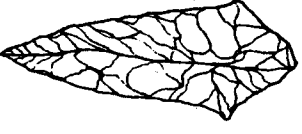

45

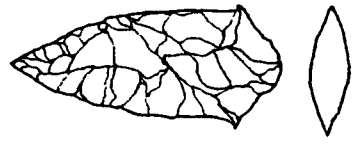

57

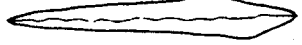
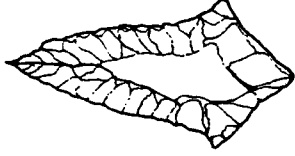

244

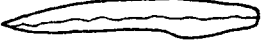
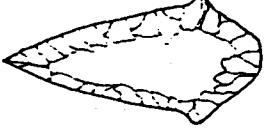

60

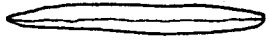
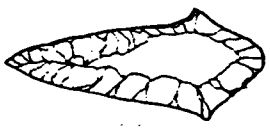

265

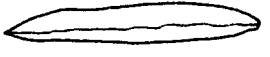

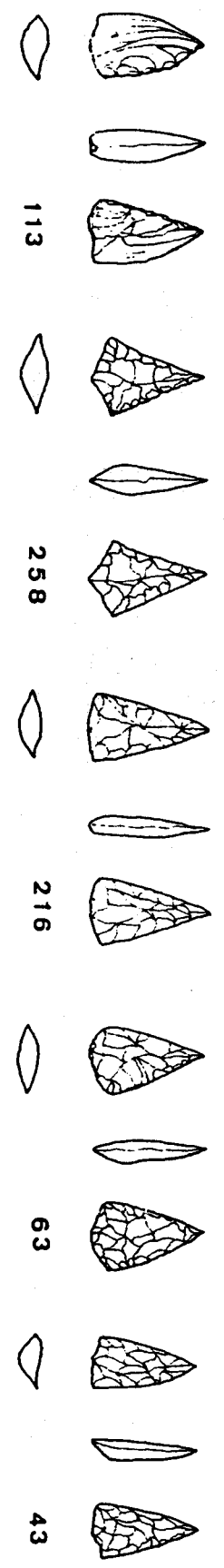
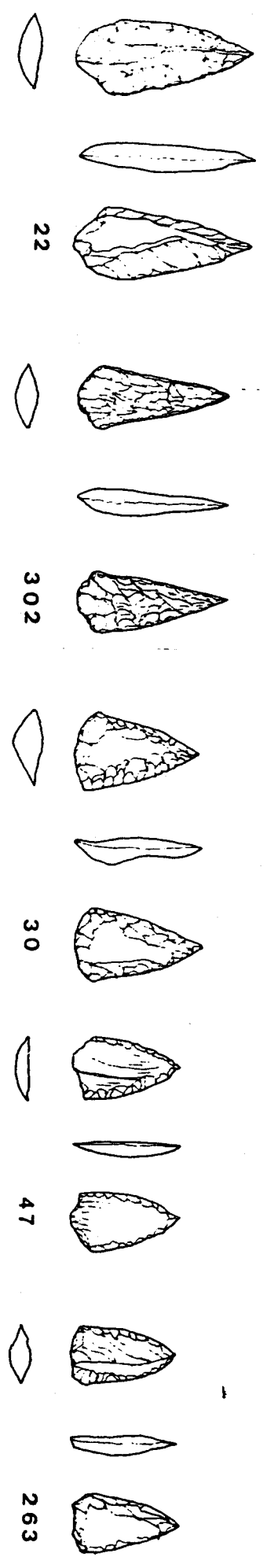

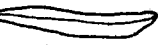
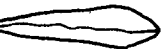
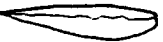
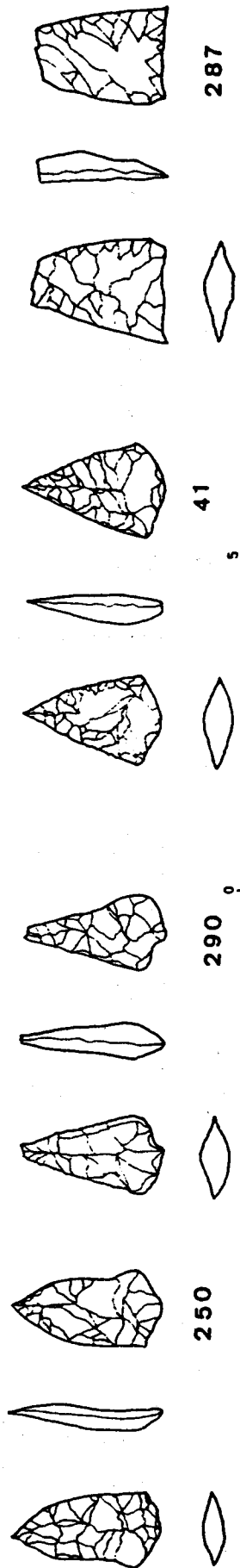
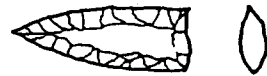
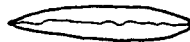
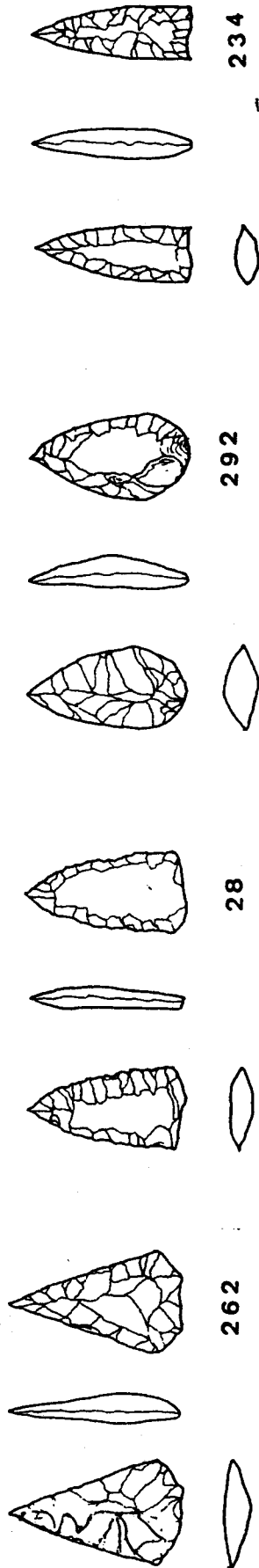
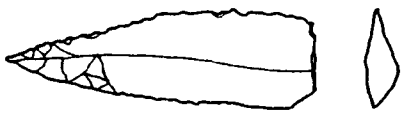
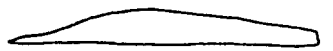
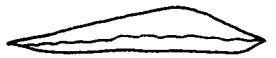
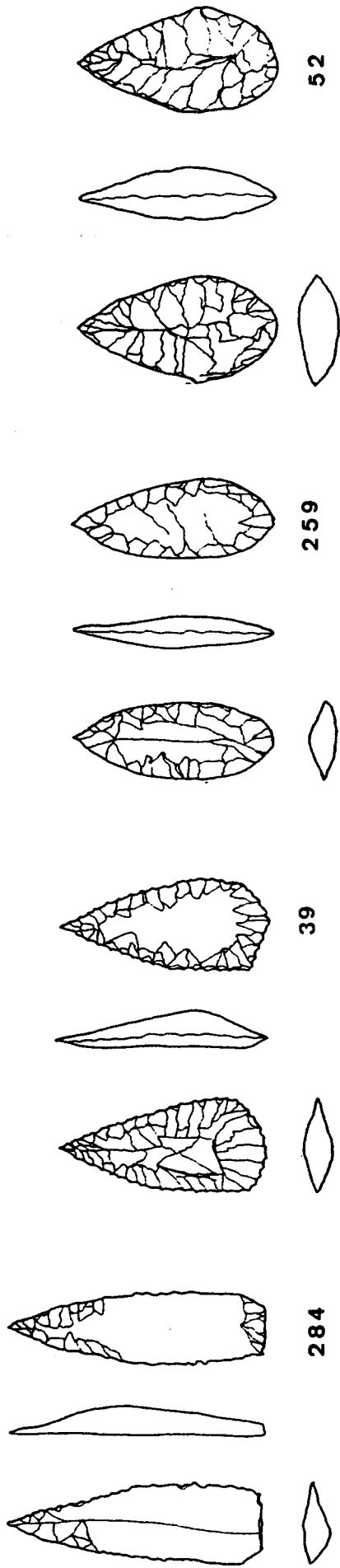

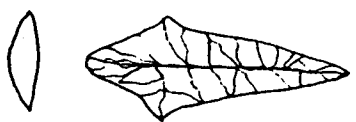

283

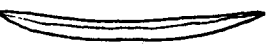
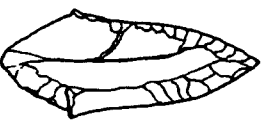
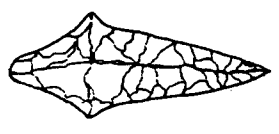
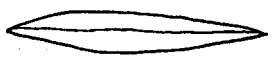

232

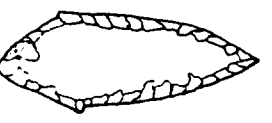

226

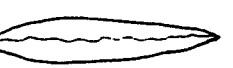
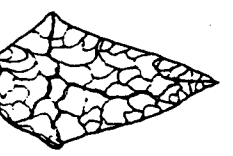

25

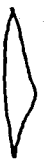
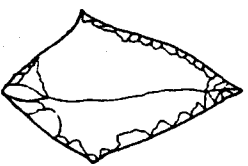

42

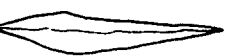
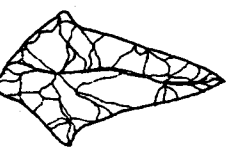
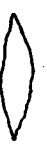
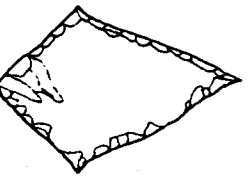
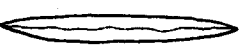

282

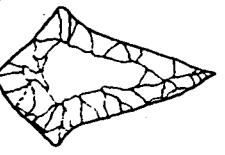

215

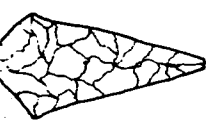

269



37

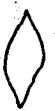

225

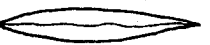
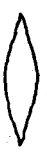
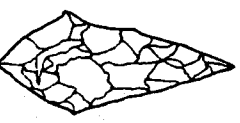

61

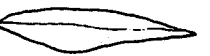
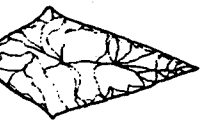
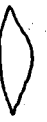
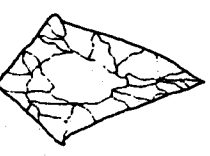

281

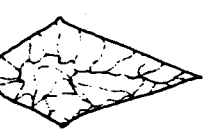

270

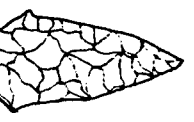

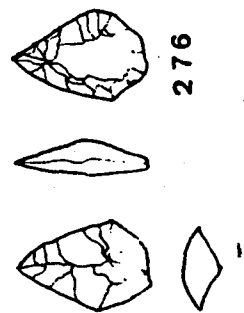
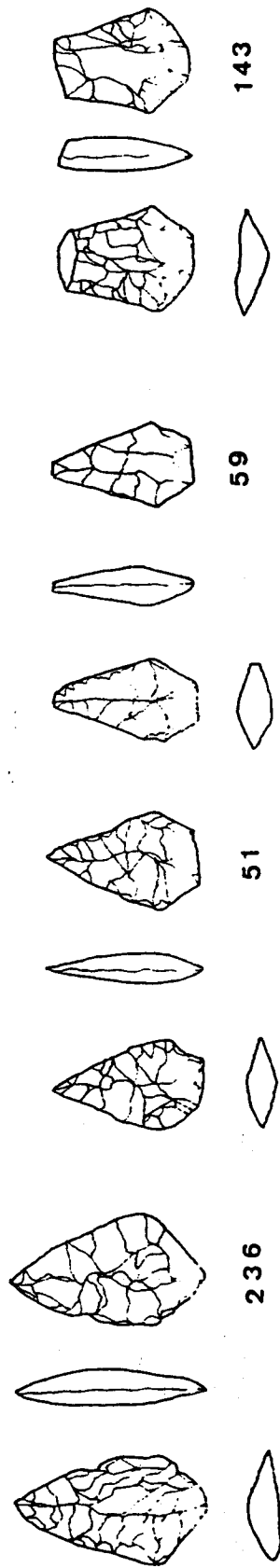
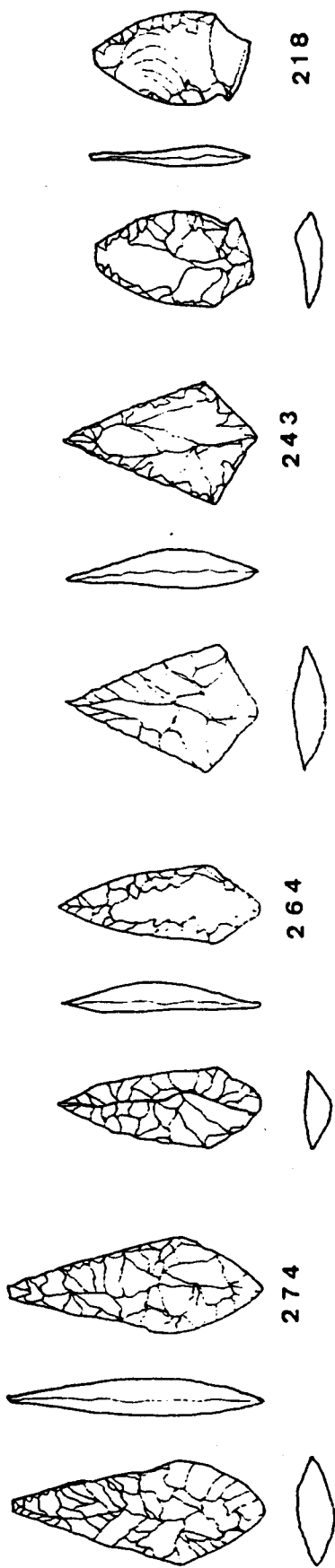



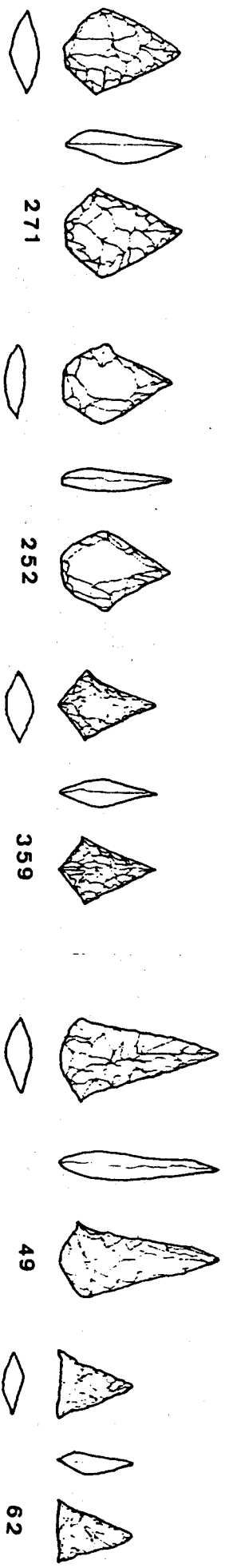
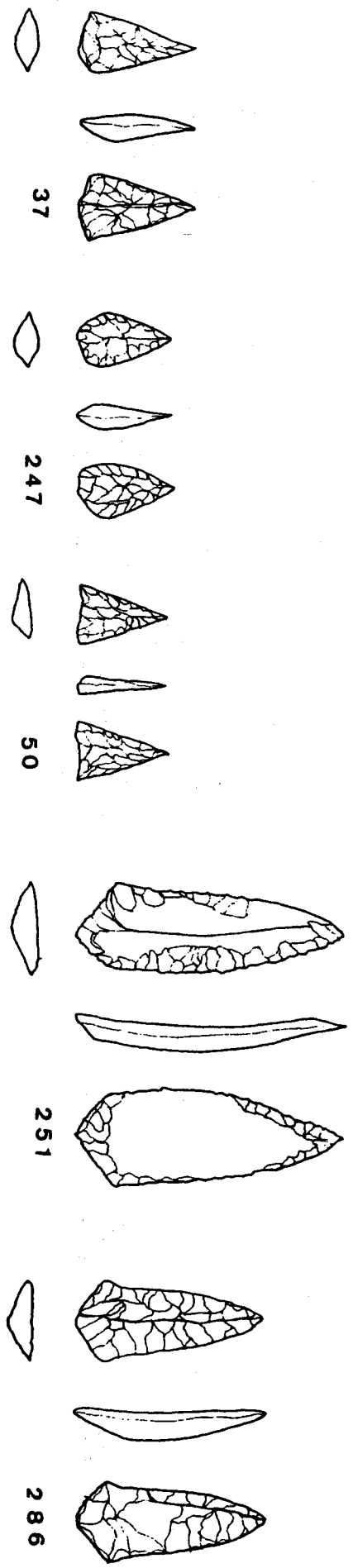
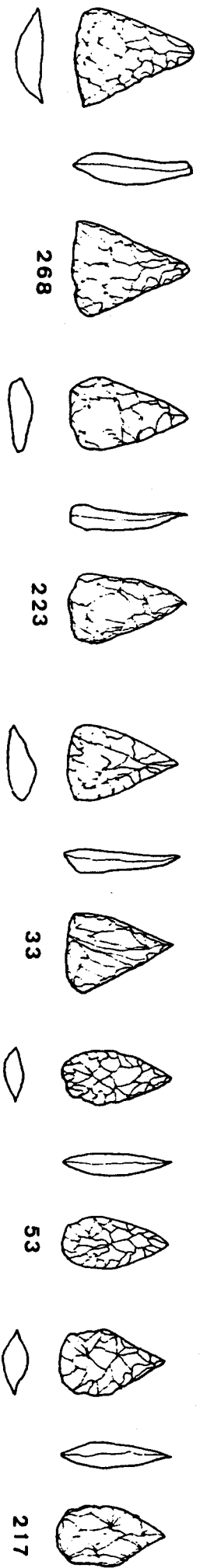

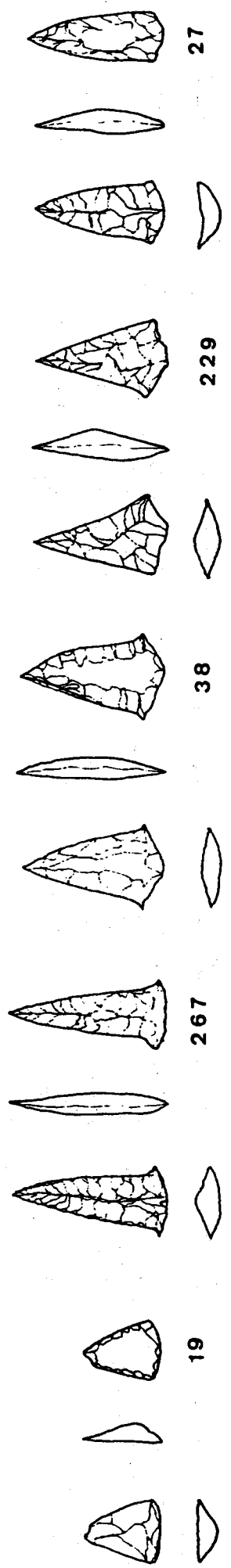
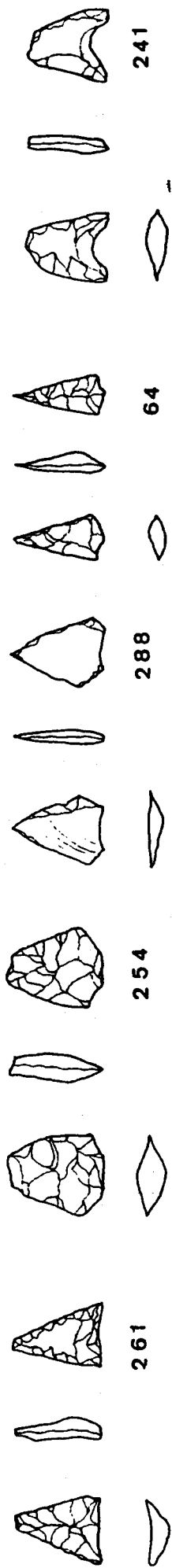
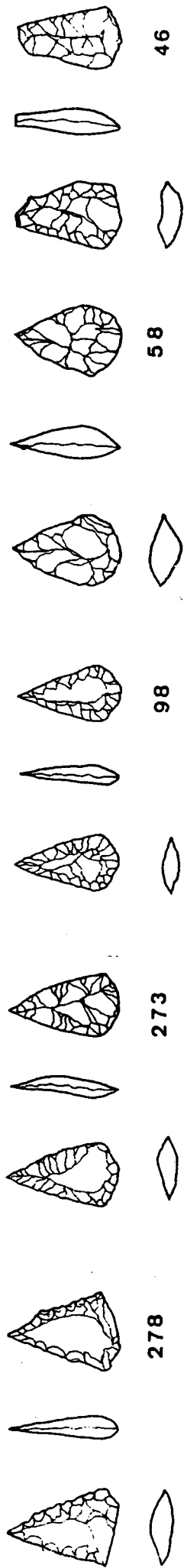



233

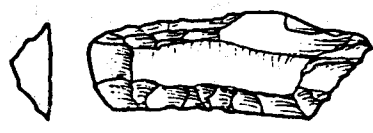
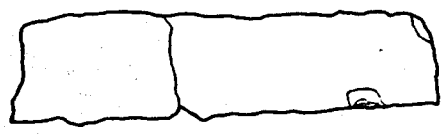

174

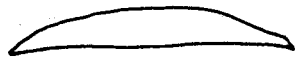

177

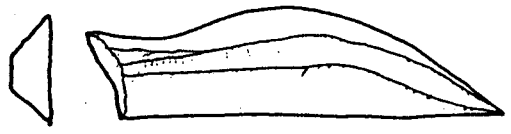
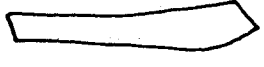

163

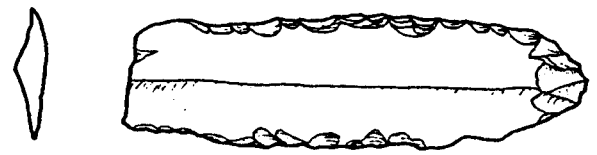
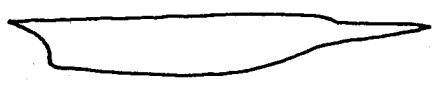

220

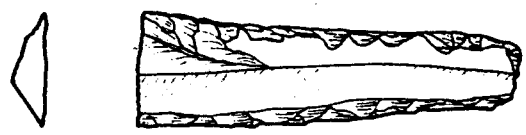
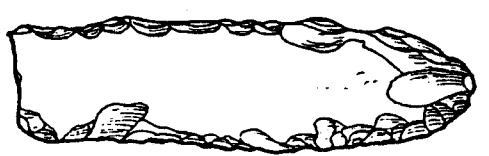
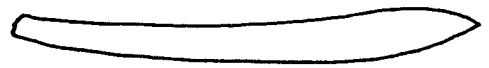

160

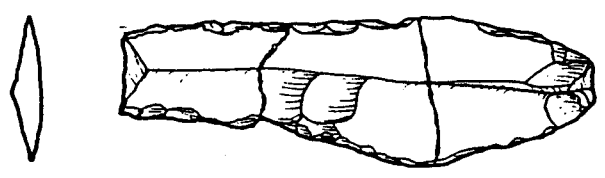
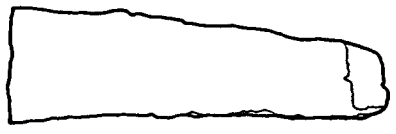
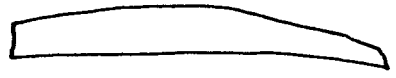

360

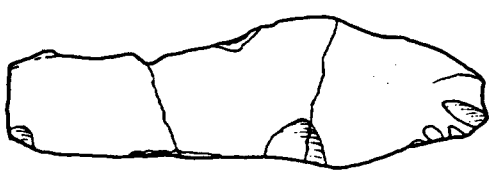

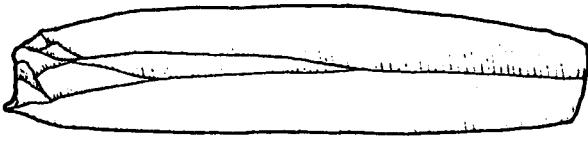

42

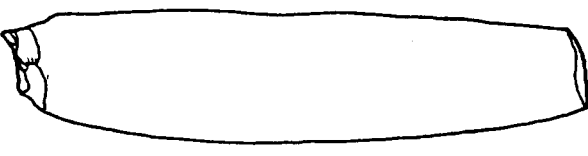

255

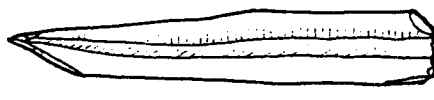

222



88

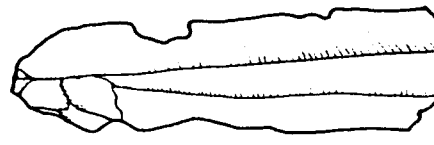

176



159



151



154

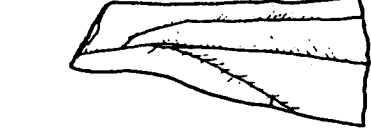

154



154

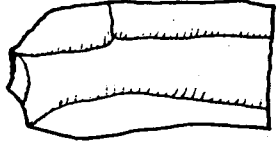

151



151

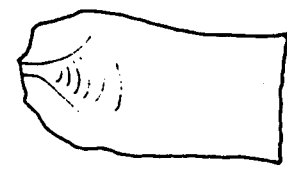

0

5

159



159

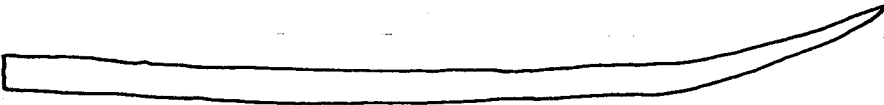
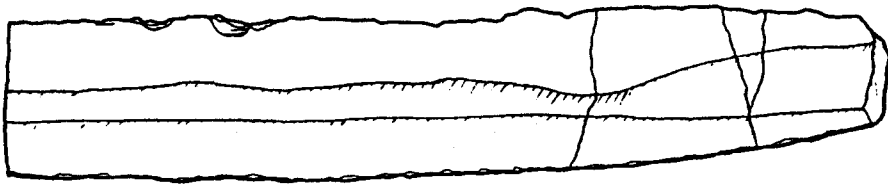

279

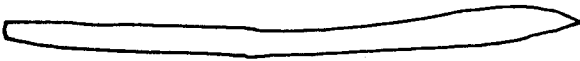
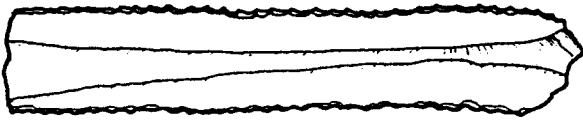
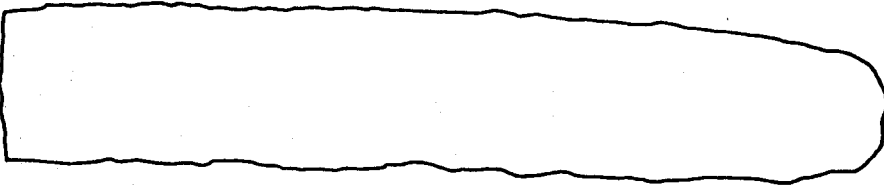

87



256

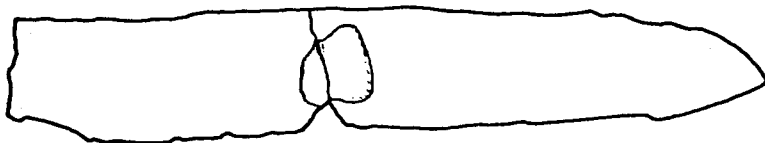



35

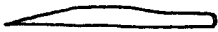

296



305

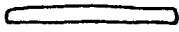

361

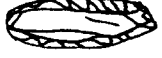

239

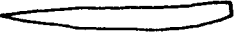

306

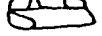

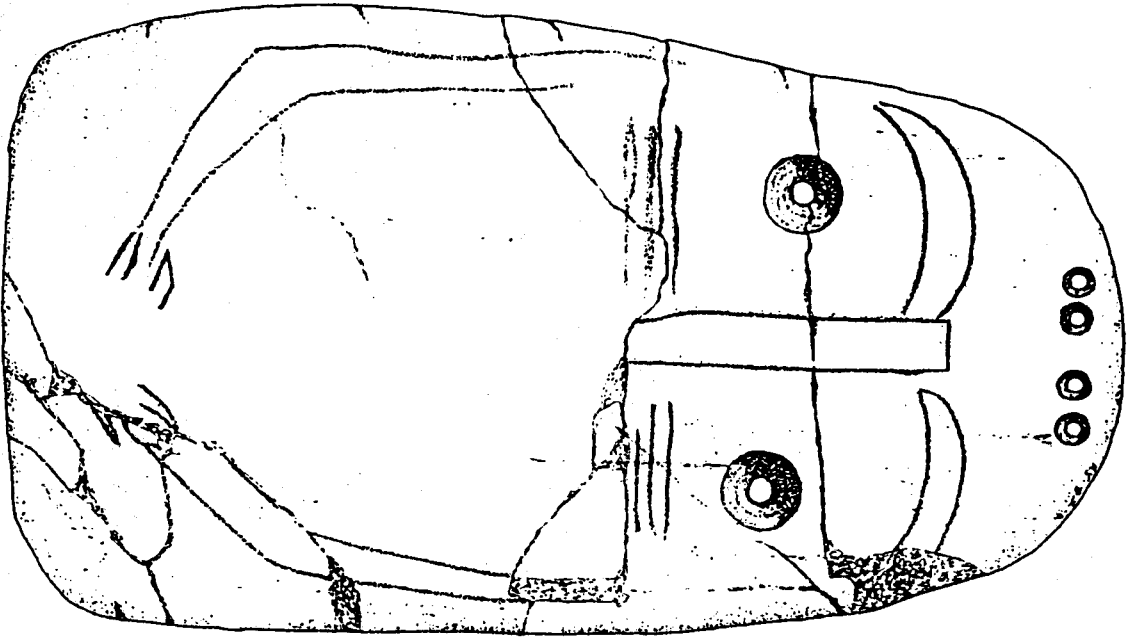

1/44

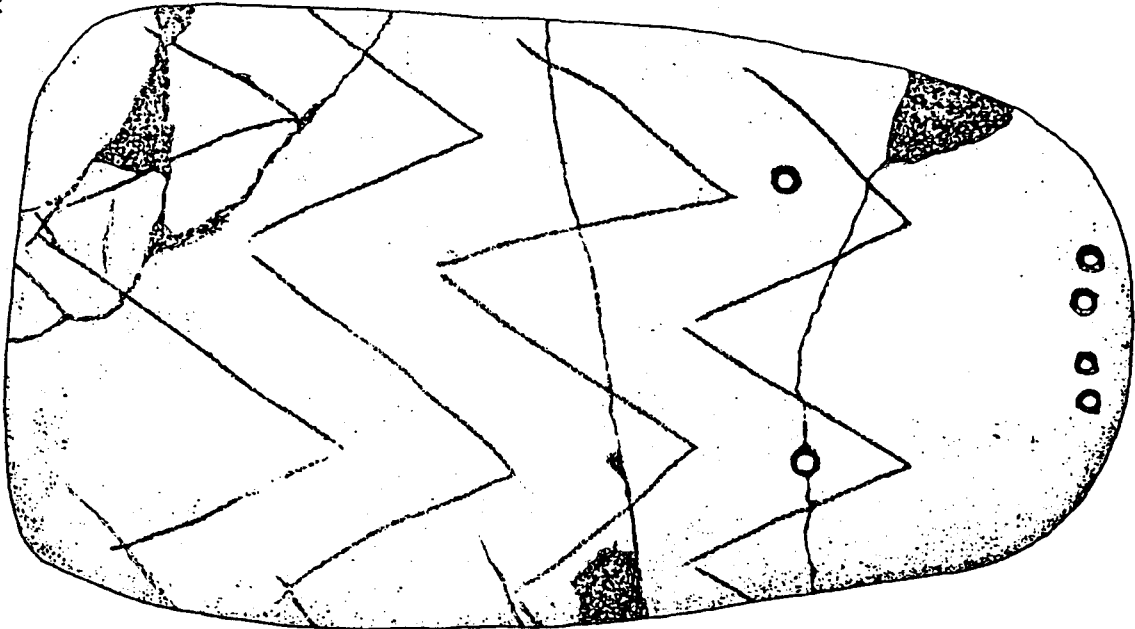

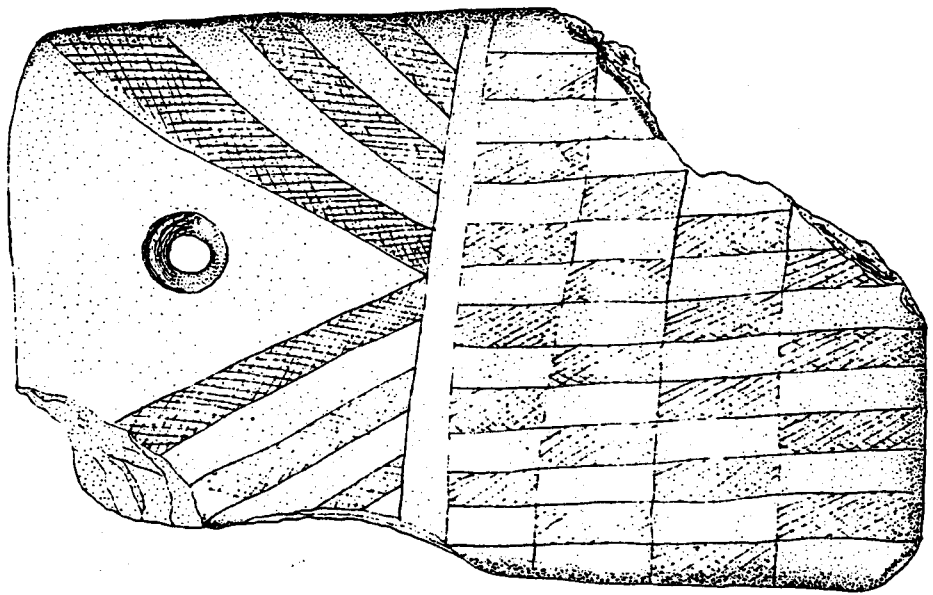
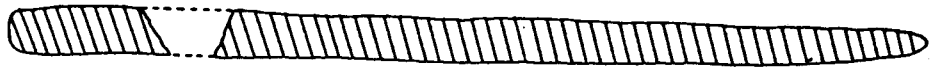
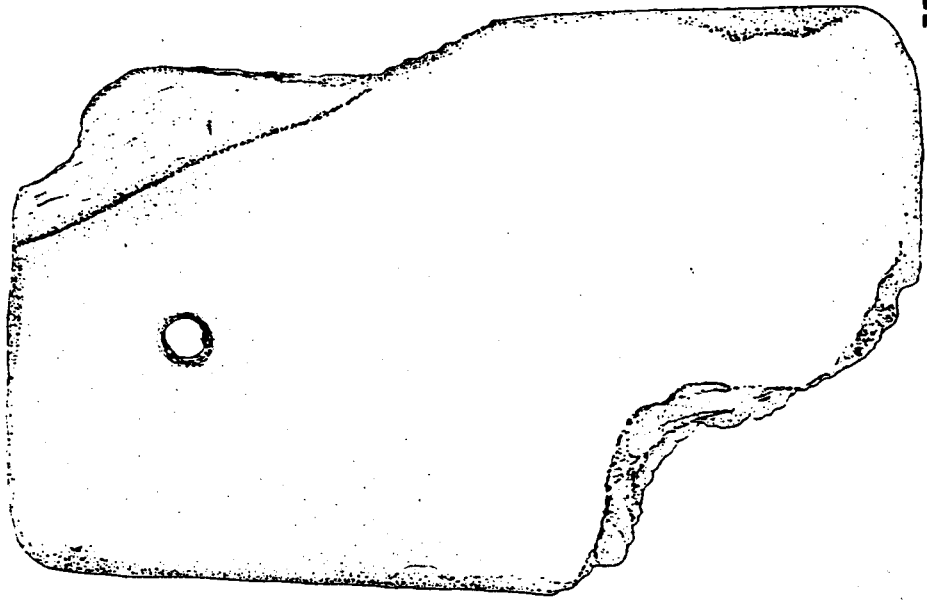



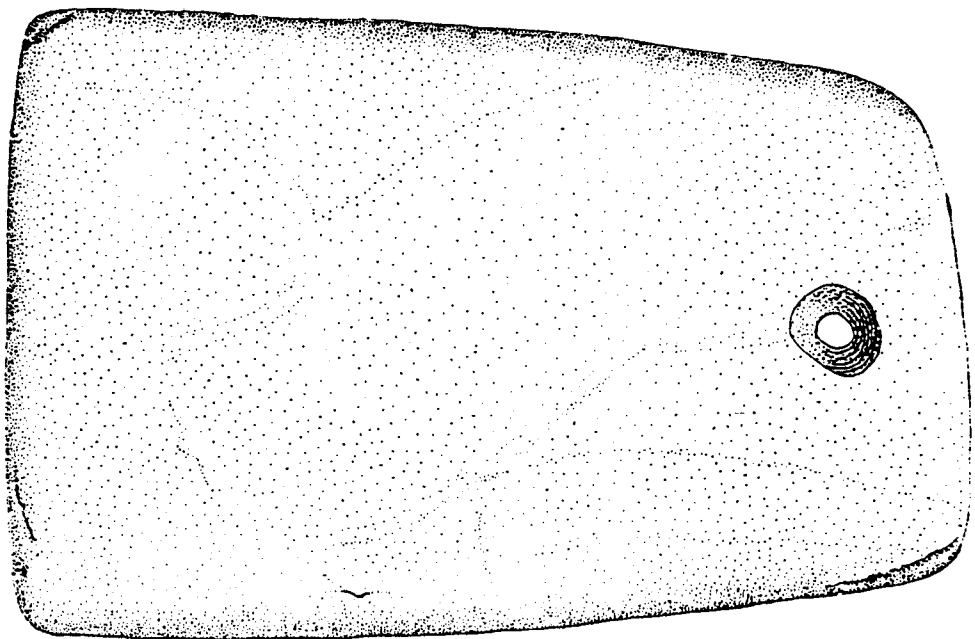
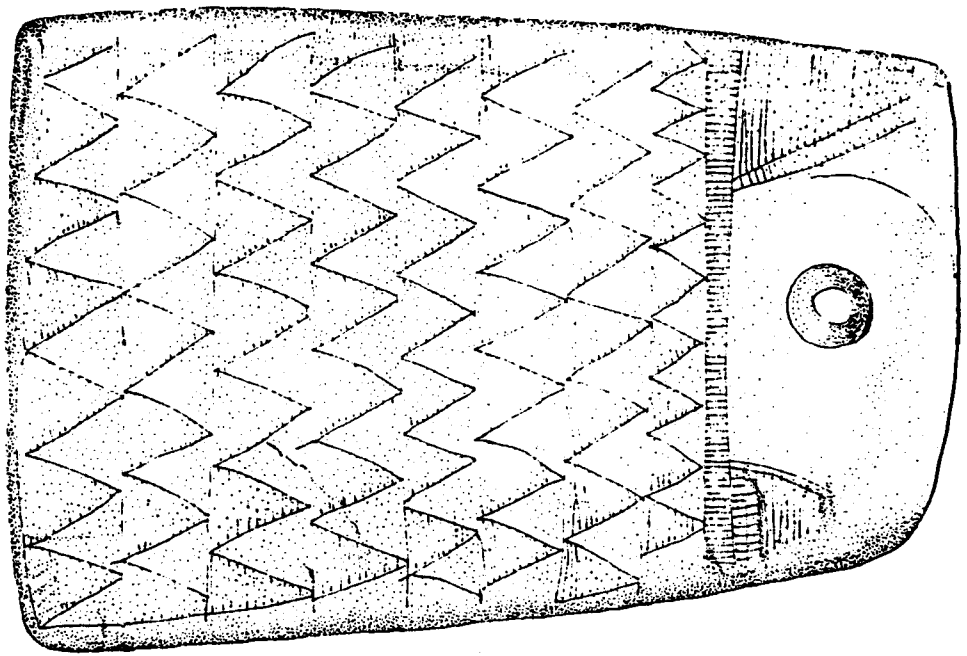

69

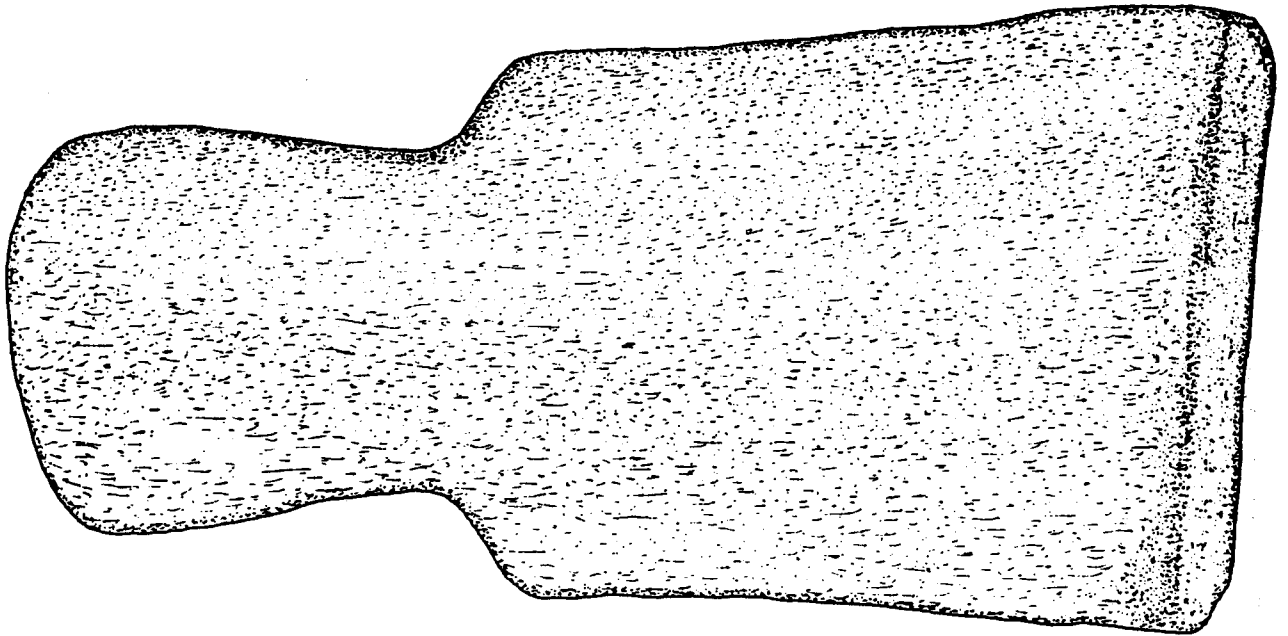

179

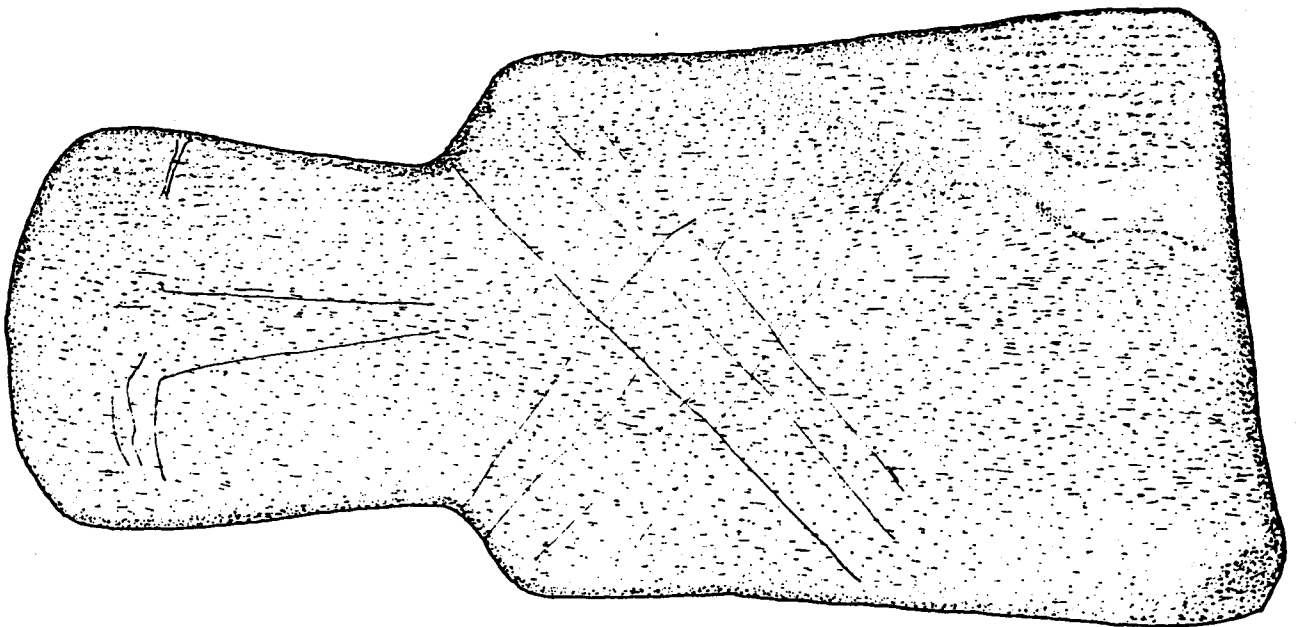

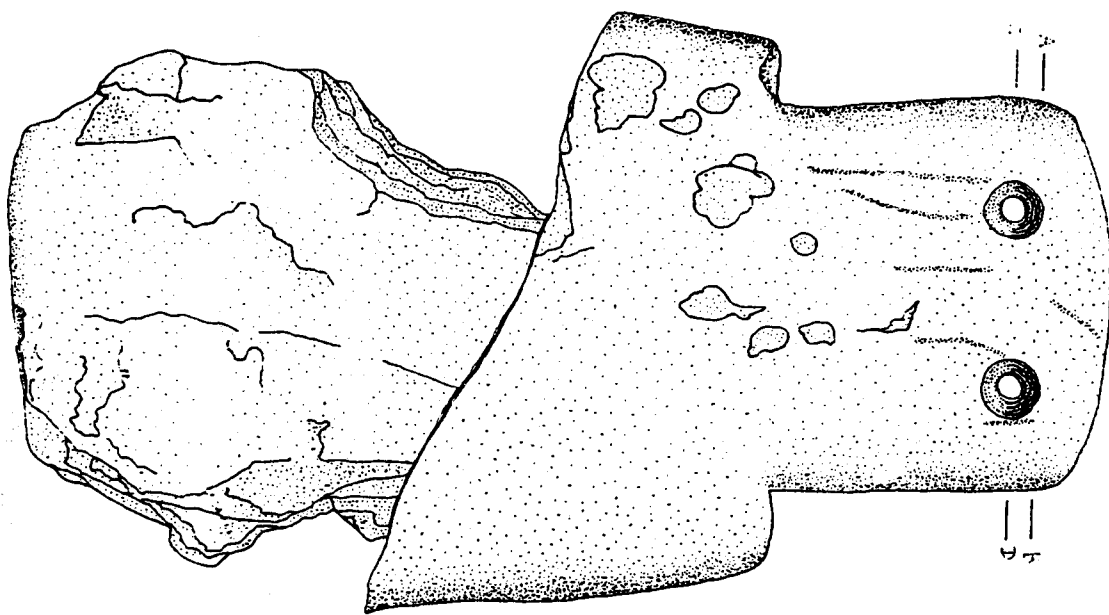

A  
B

C

1  
2

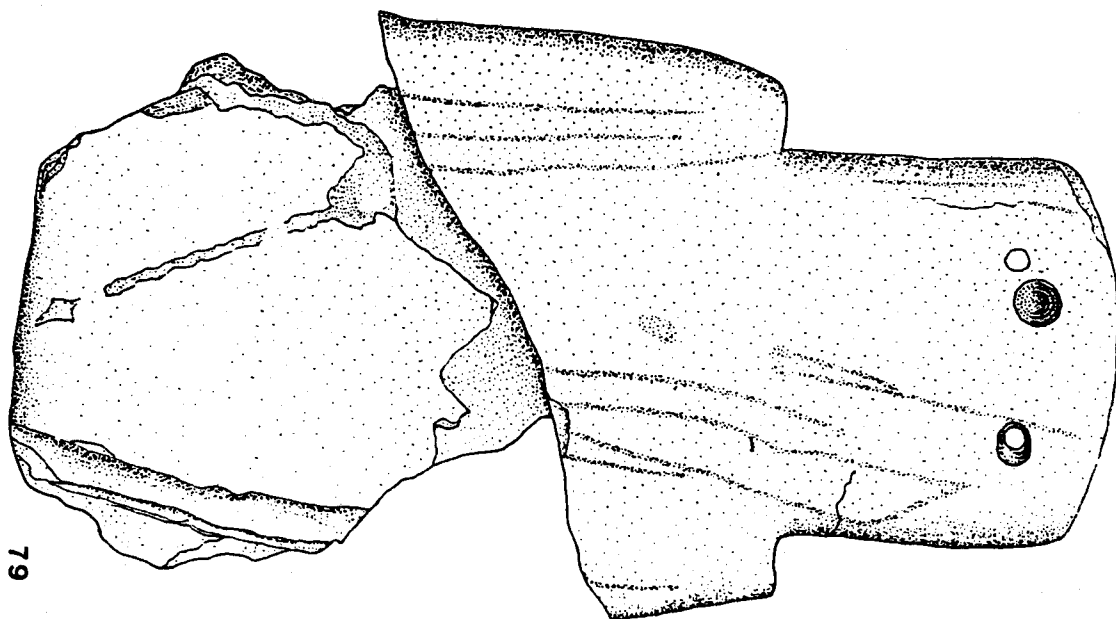

79

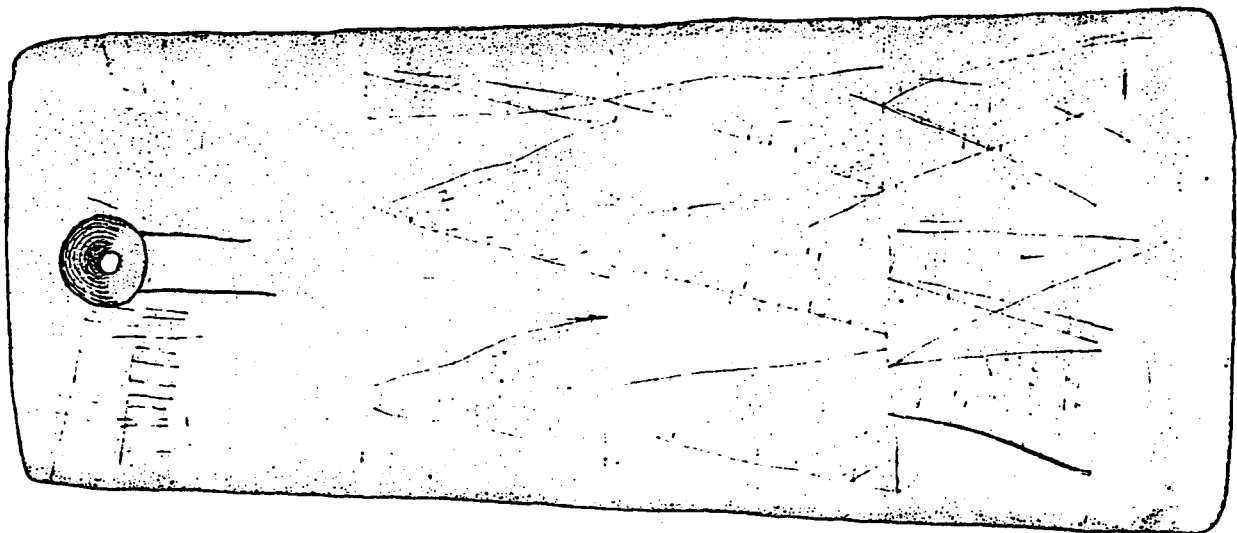
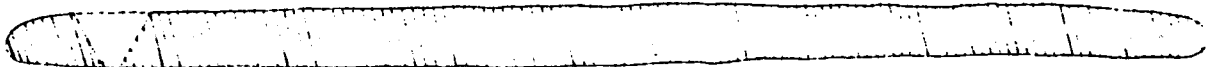
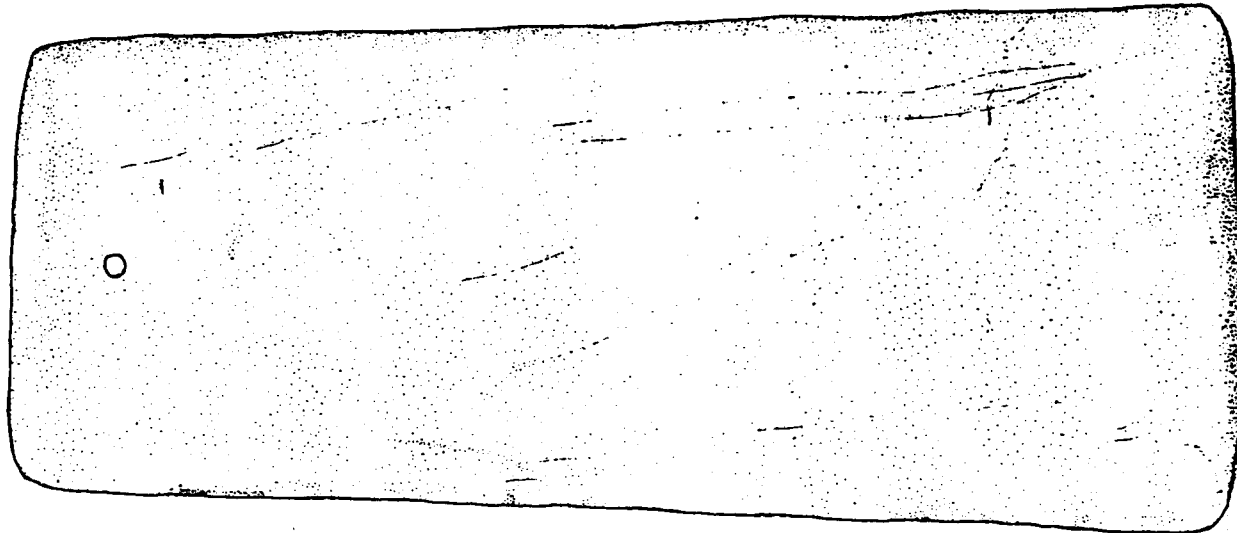

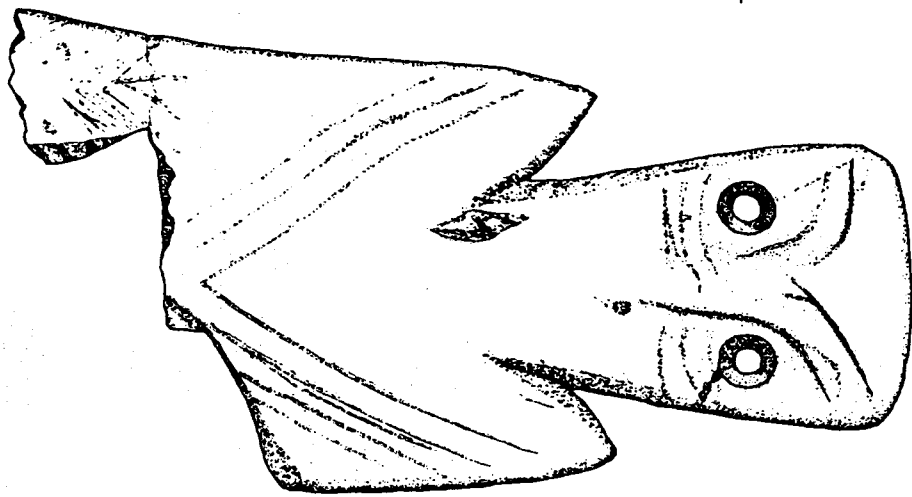

98

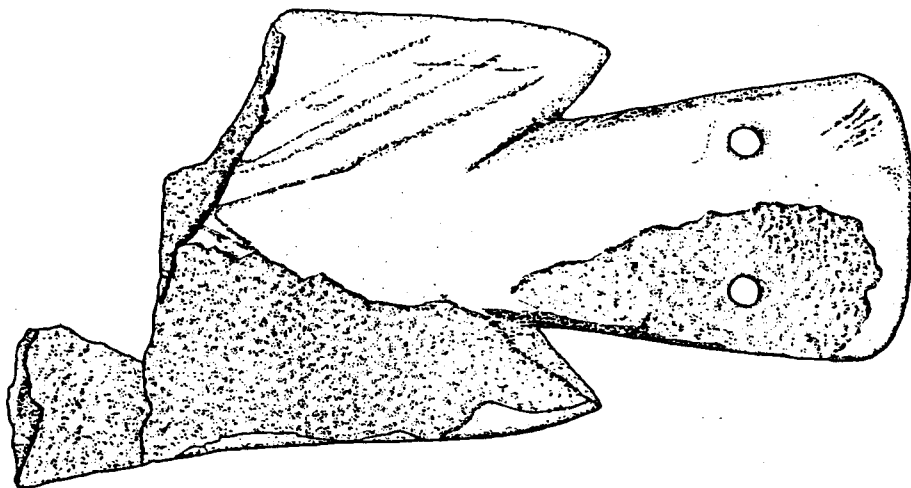

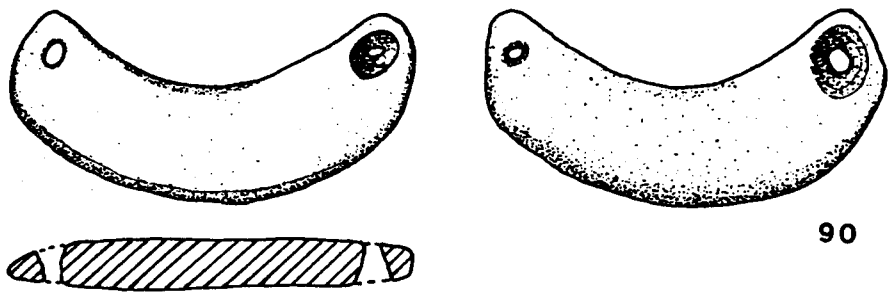

90

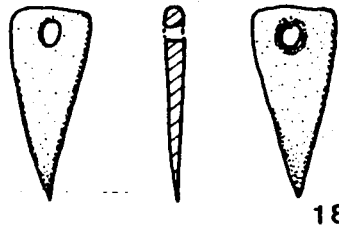

18

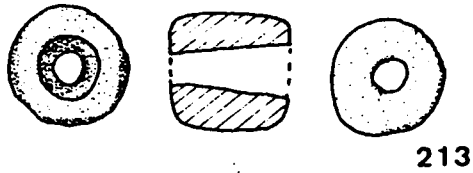

213



2 - 17



180 - 212



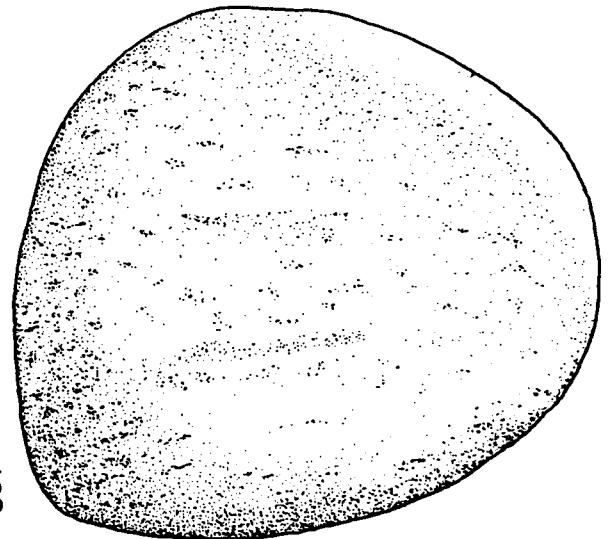
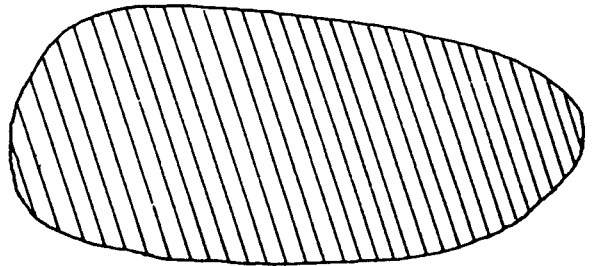
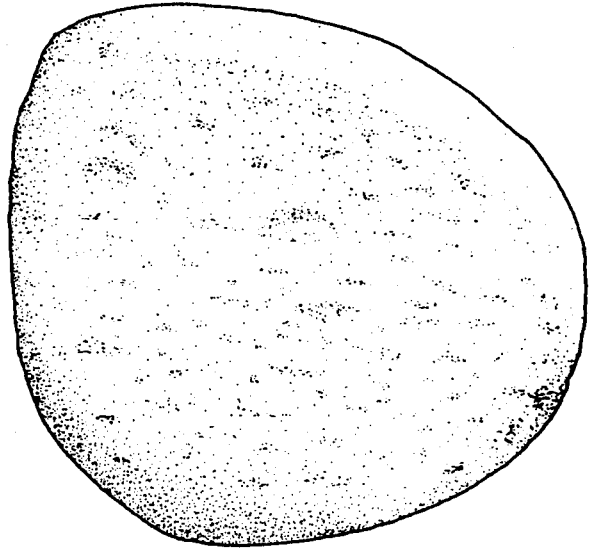
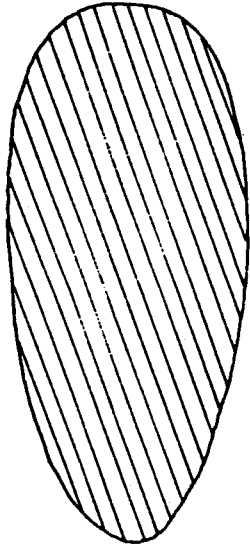

162

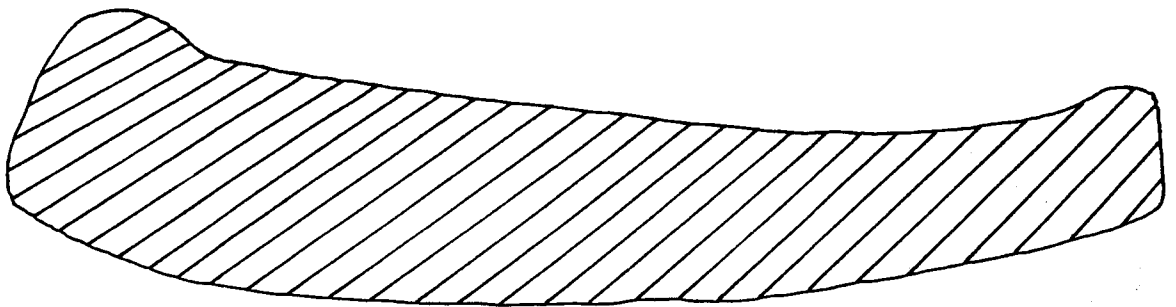
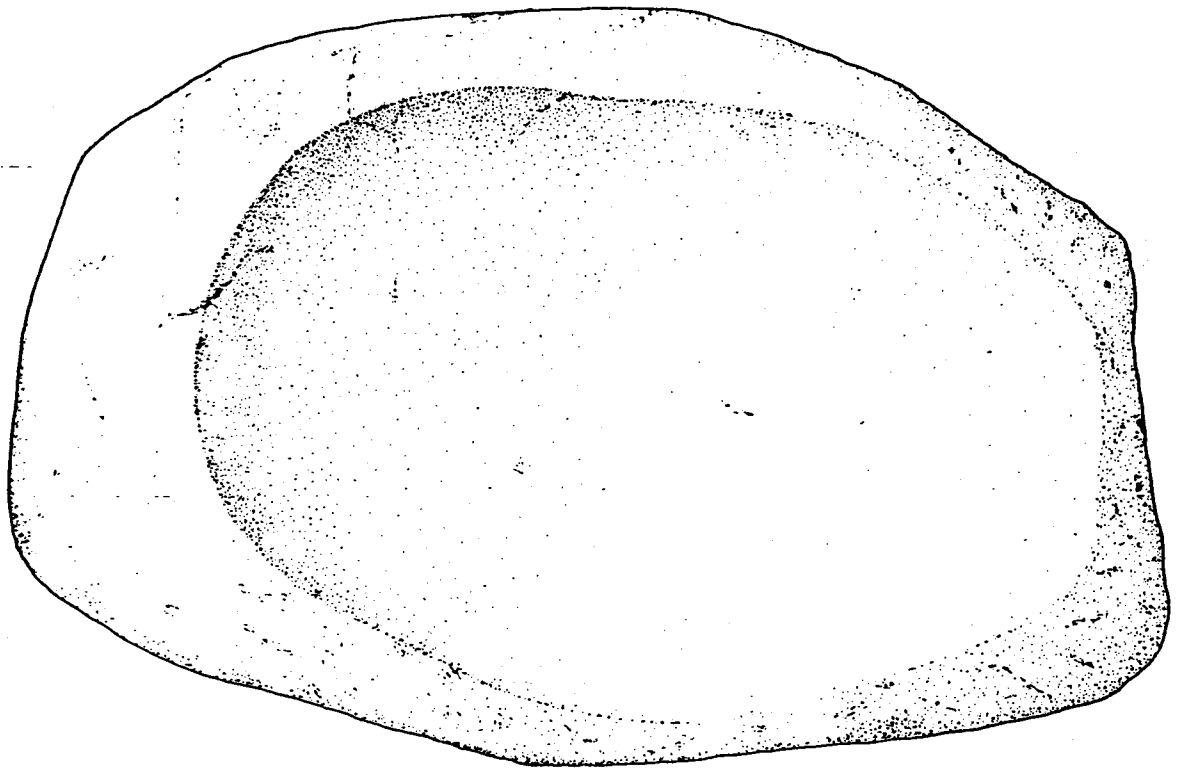



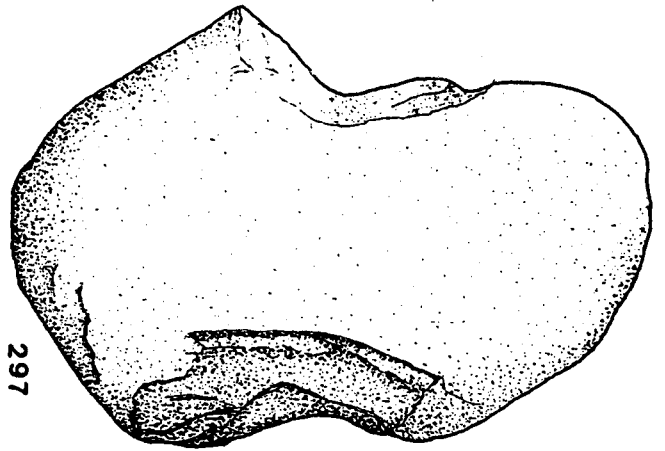
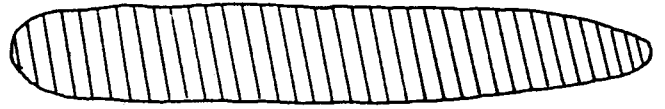
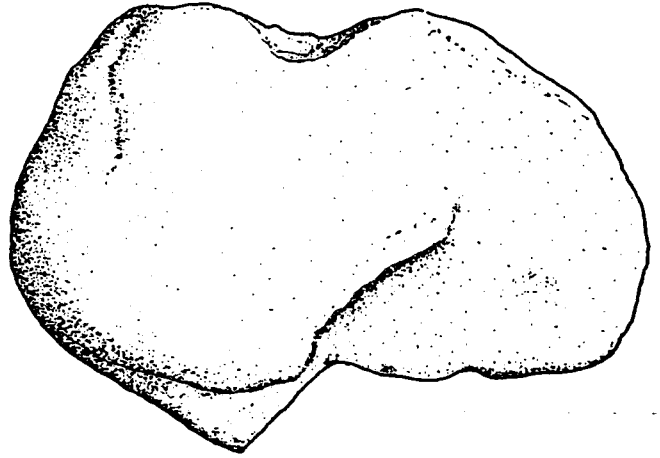

297

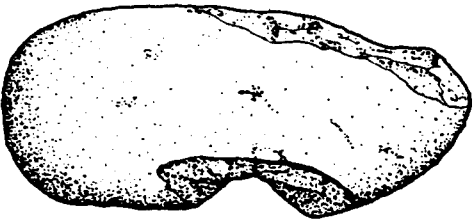
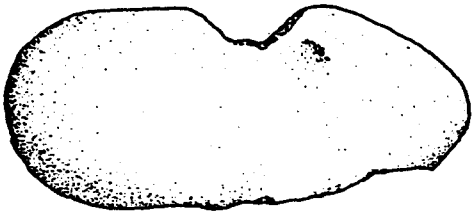

298



ANTA  
da  
**CABEÇUDA**



C 107

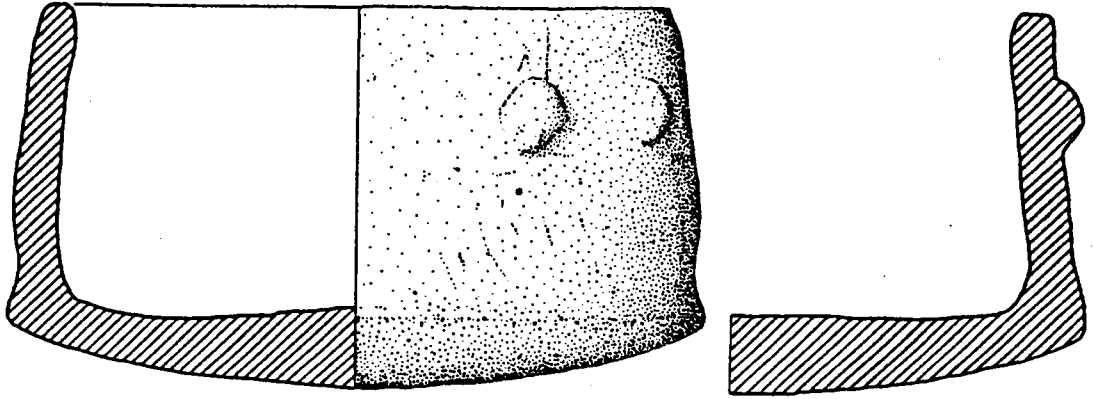

C 108

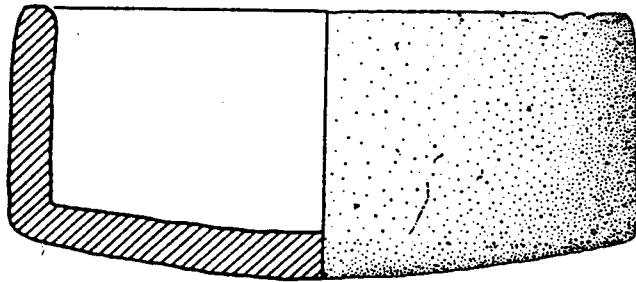

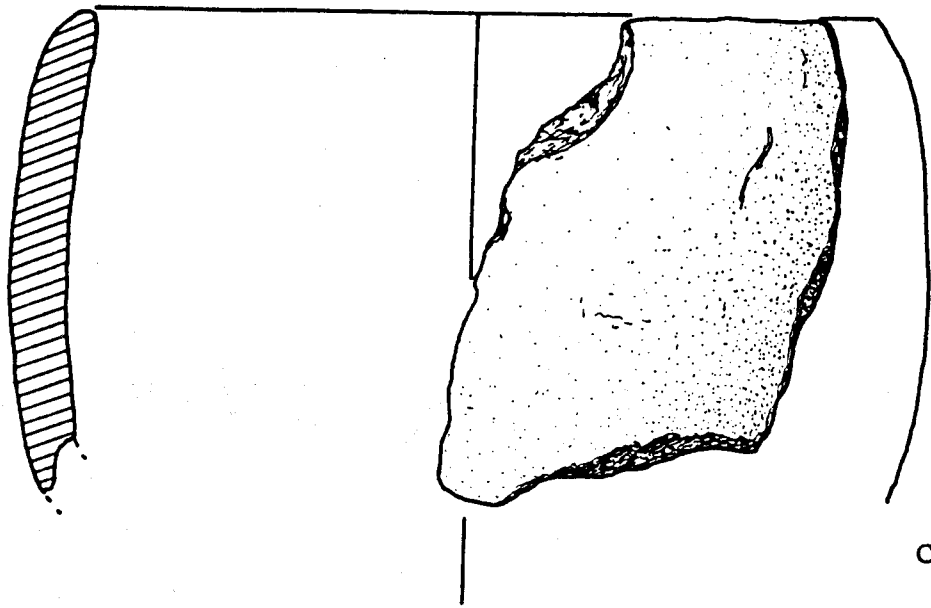

C226

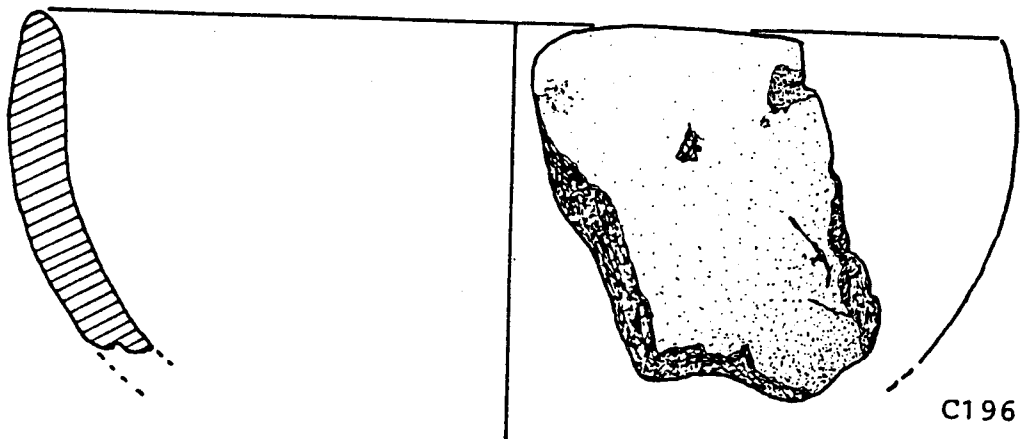

C196

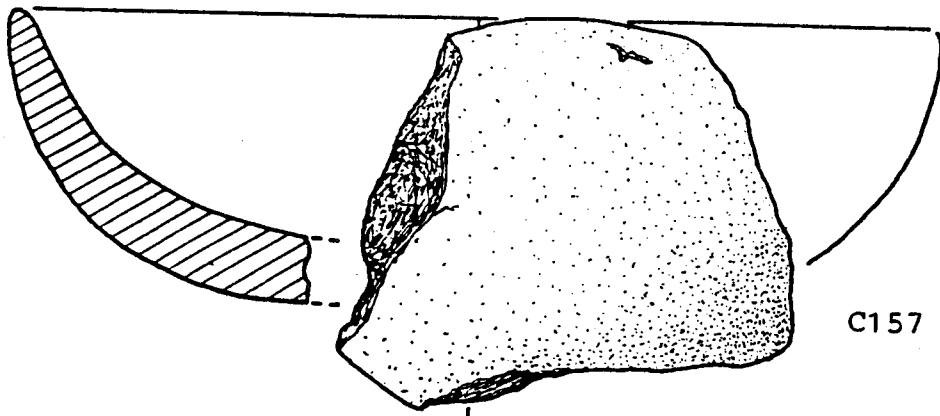

C157



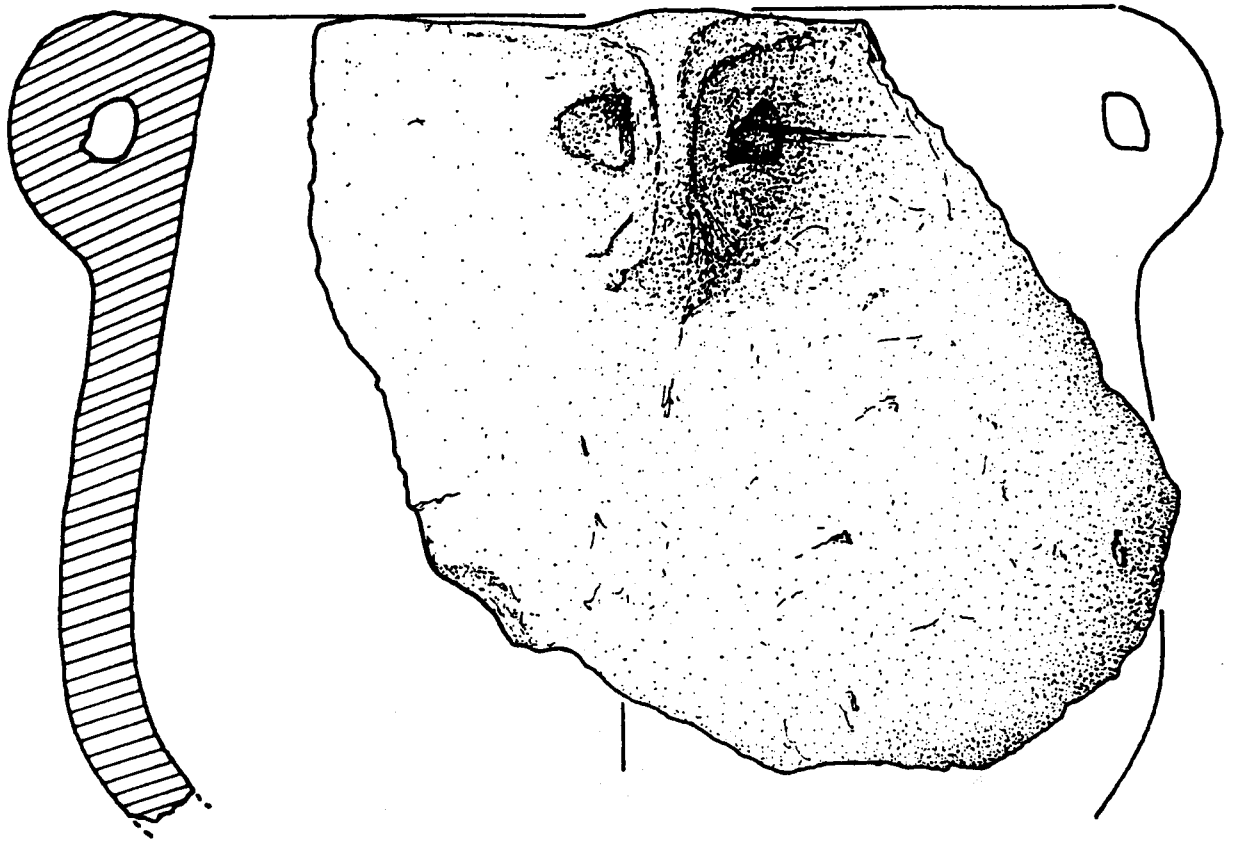

C 106

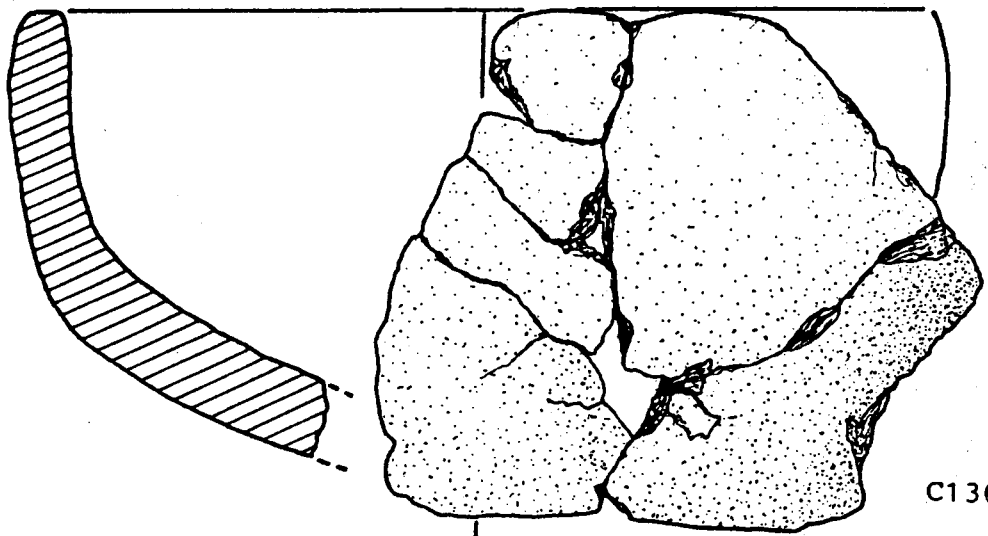

C136



C 105

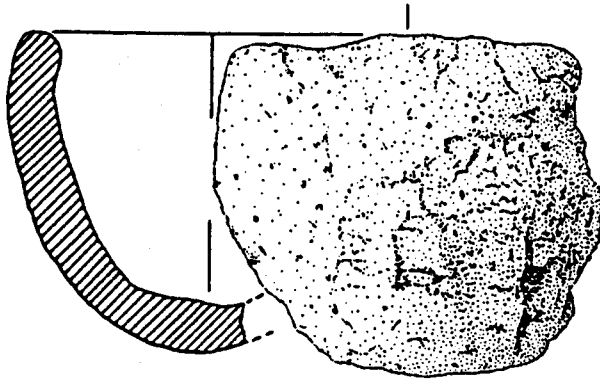

C 148

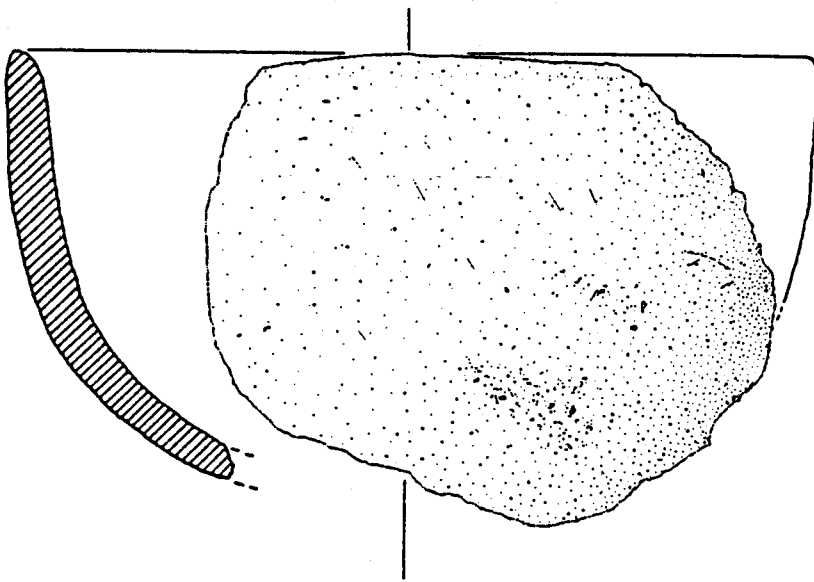

C 229

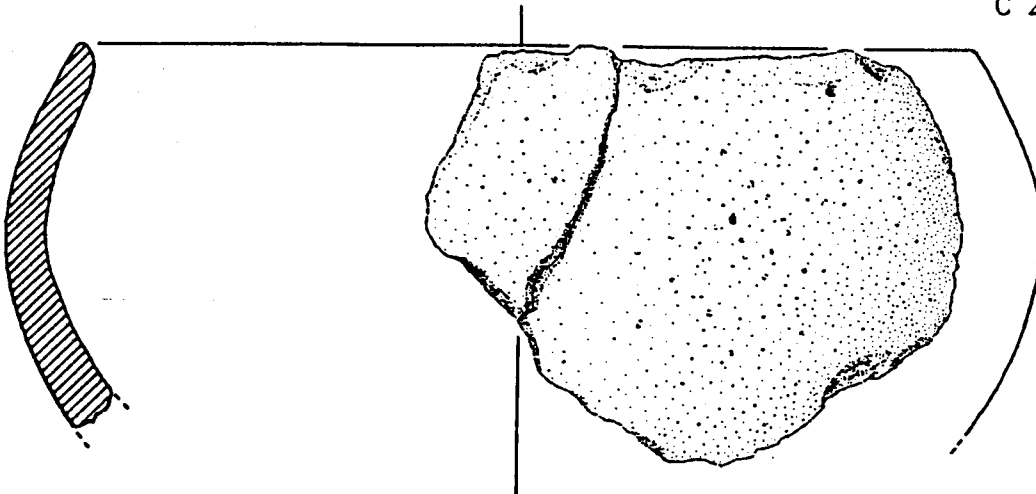

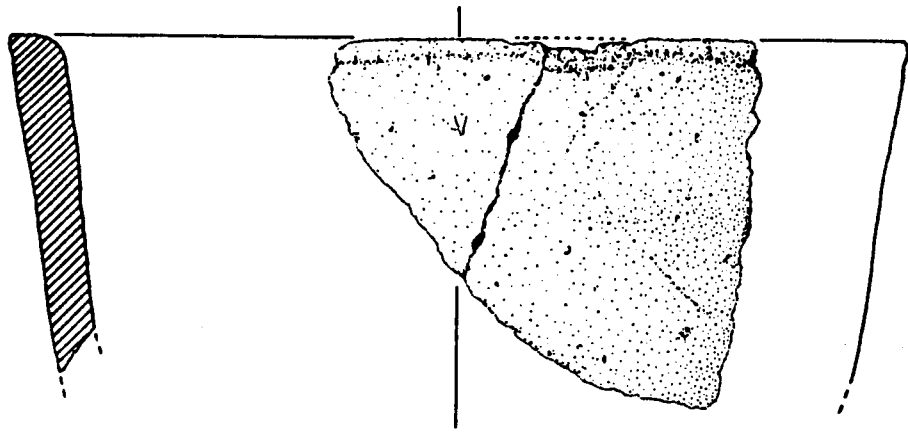

C 111

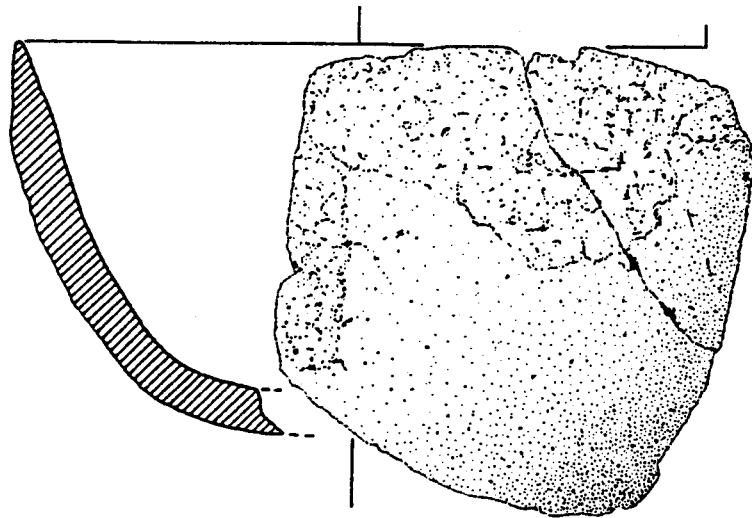

C171



C 150

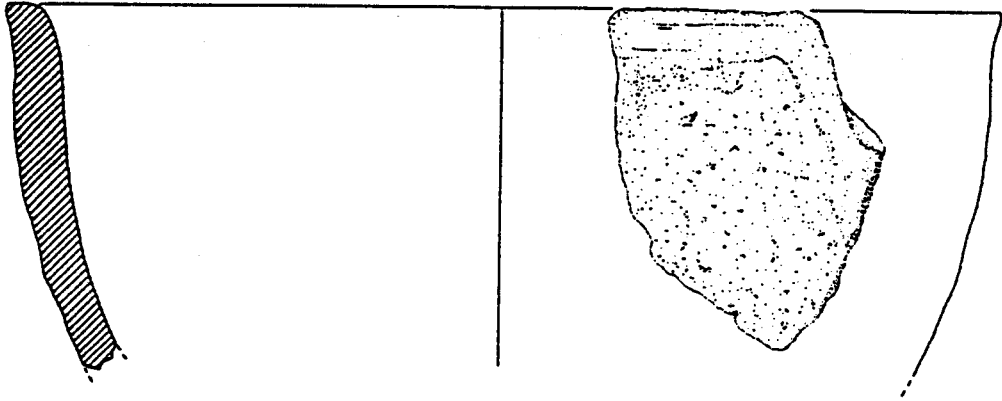

C 158

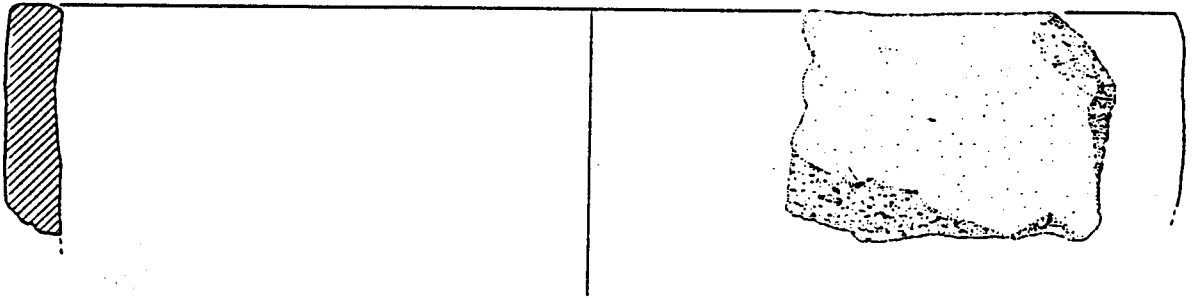

C 224

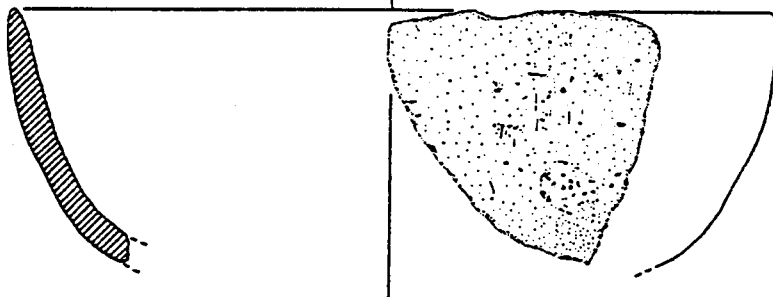

C 138

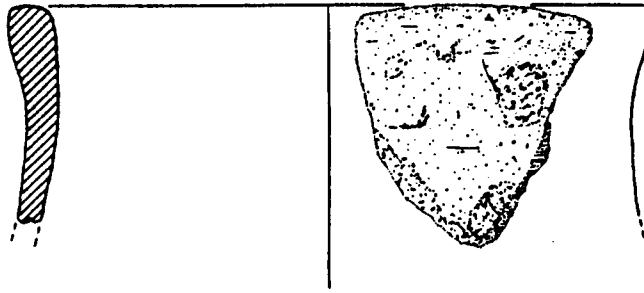

C 208

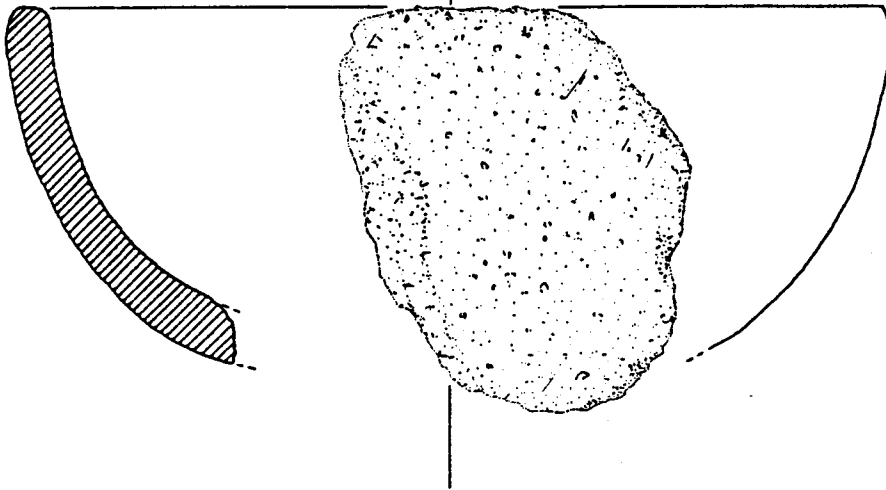

C 202

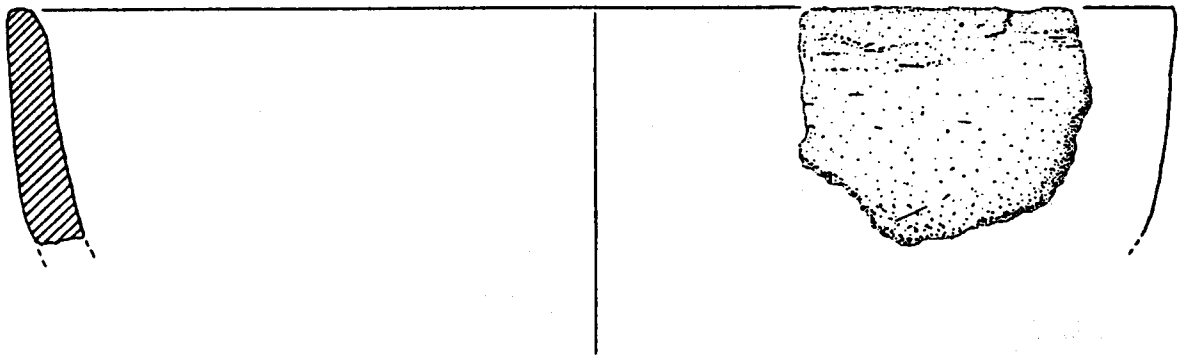

C 145

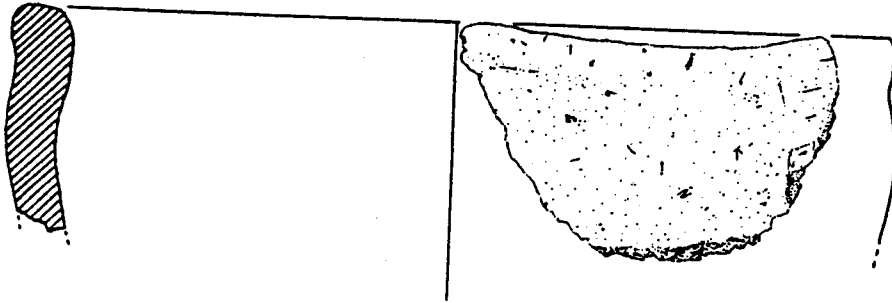

C 129

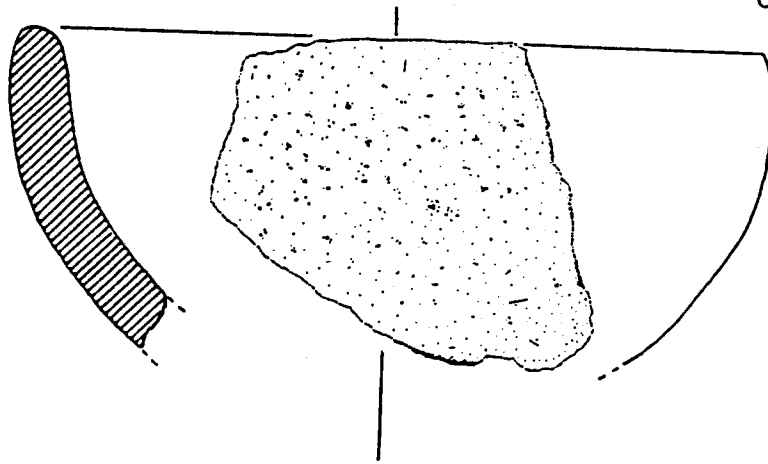

C 207

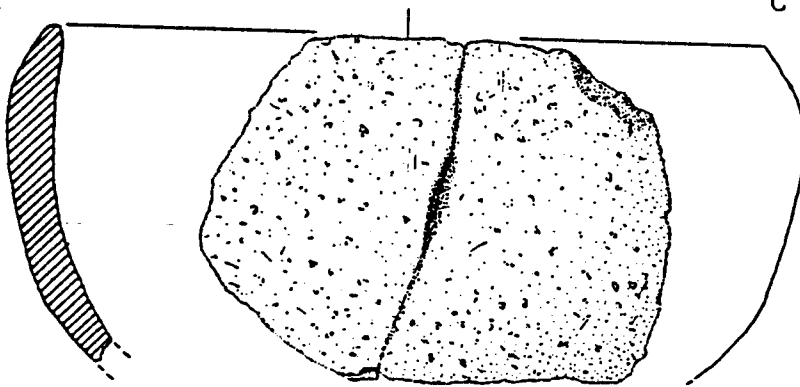

65

0

5cm

C 173

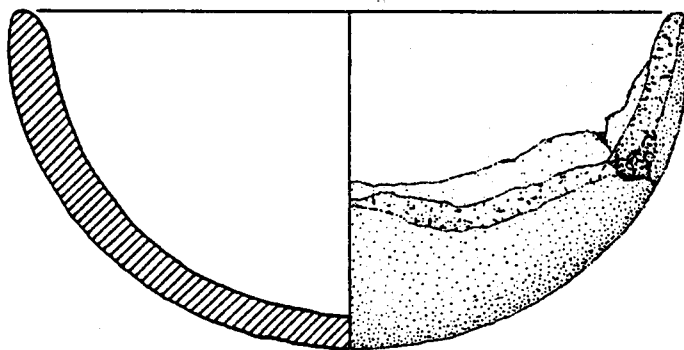

C 156

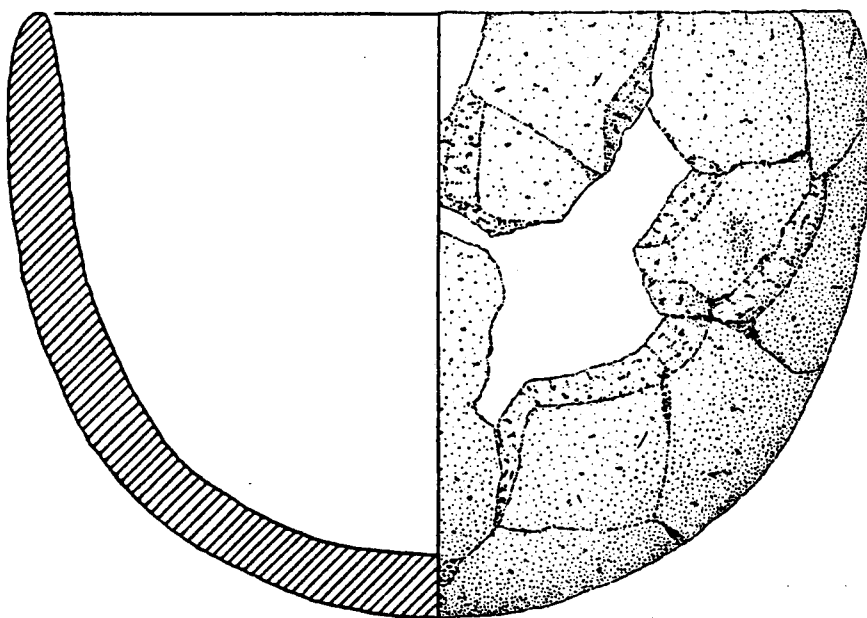

C 132

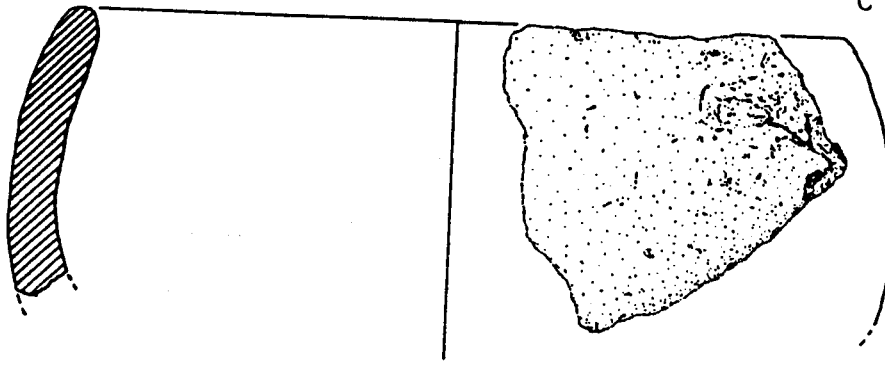

C 235

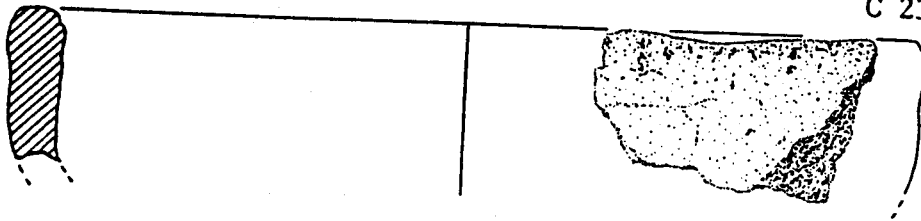

C 188

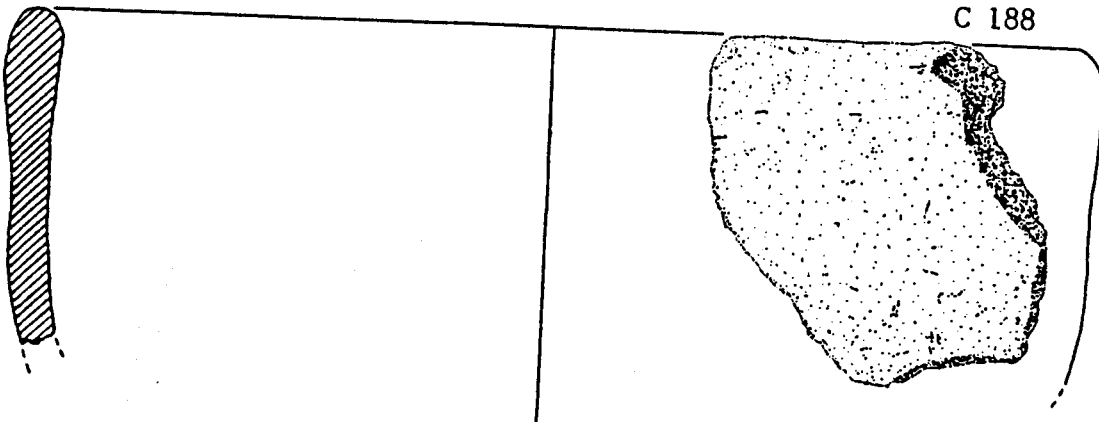

C 144

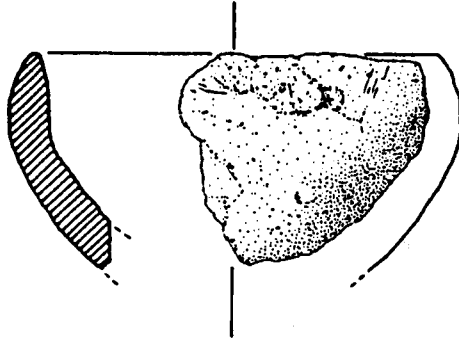

C 137

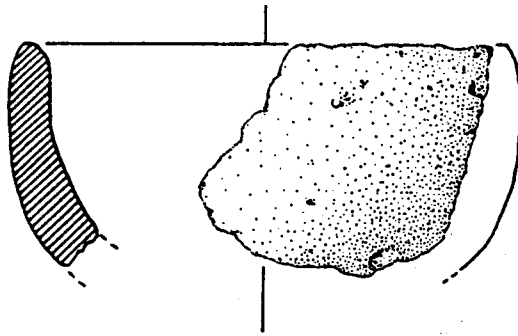

C 151

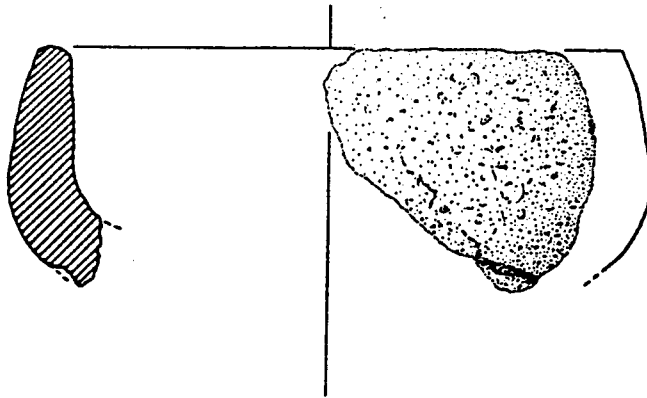

C 222

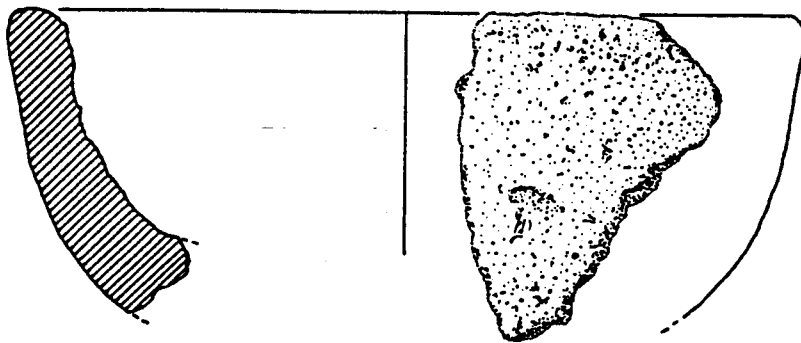

C 153

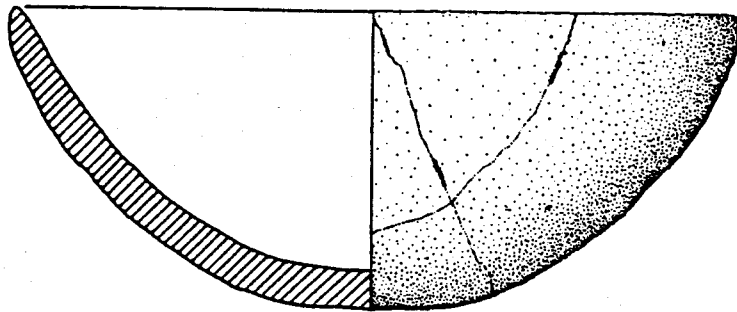

C 174

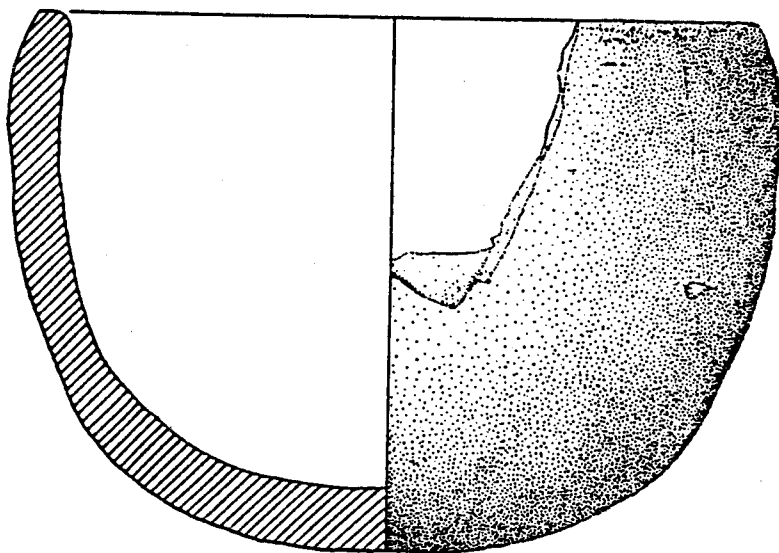

C 205

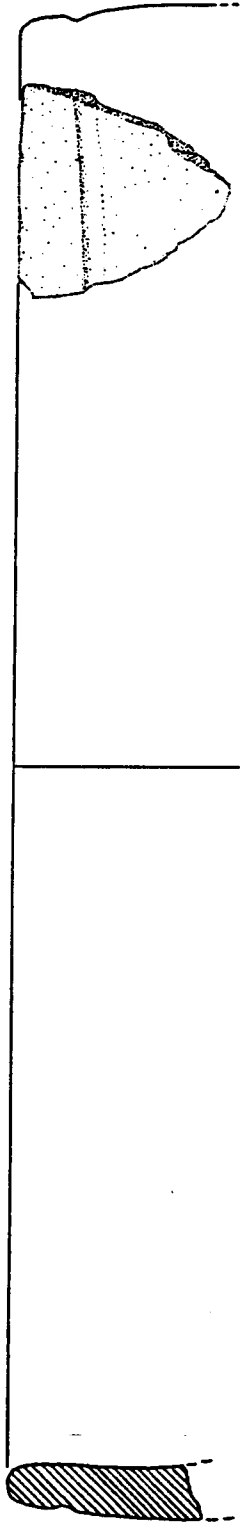

C 135

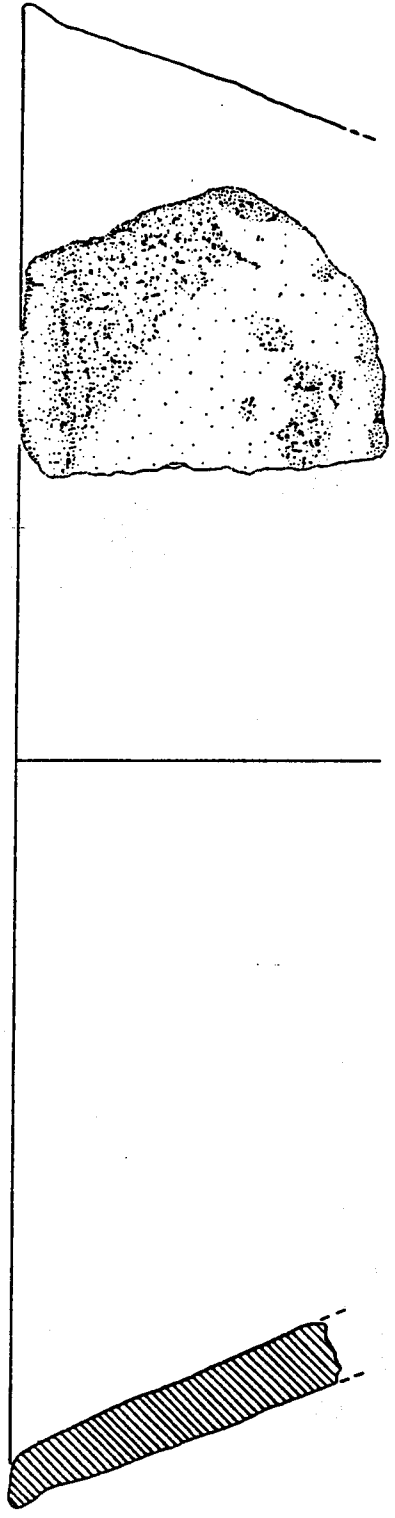



C 149

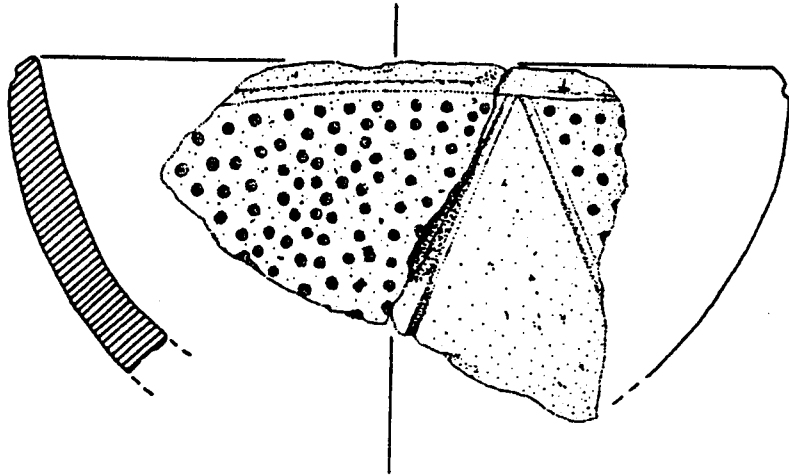

C 146

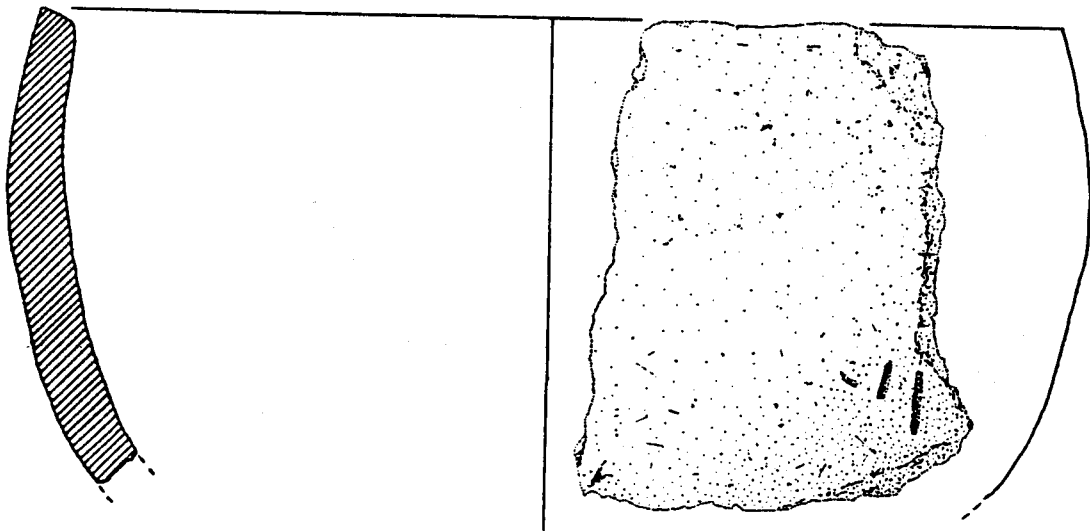

C 152

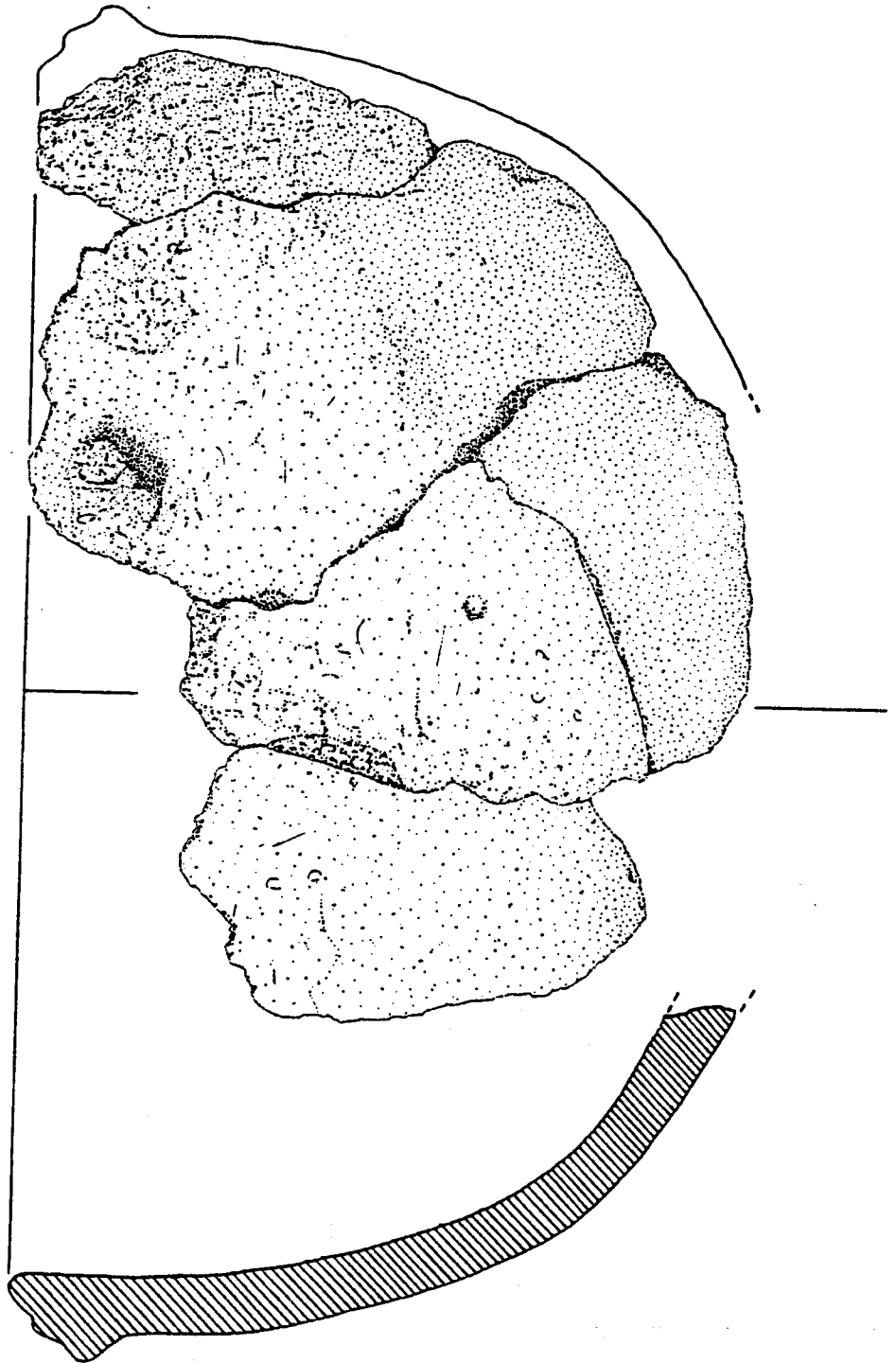

C 142

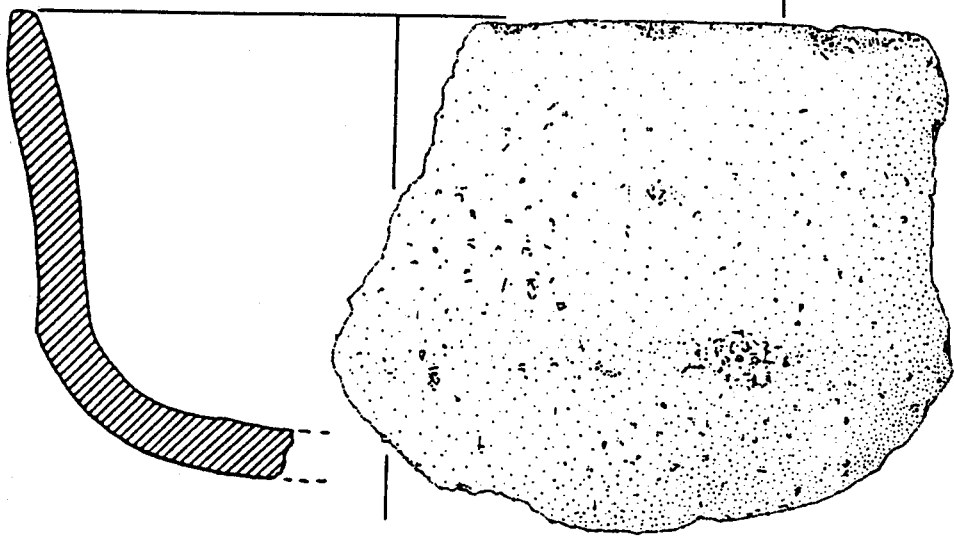

C 161

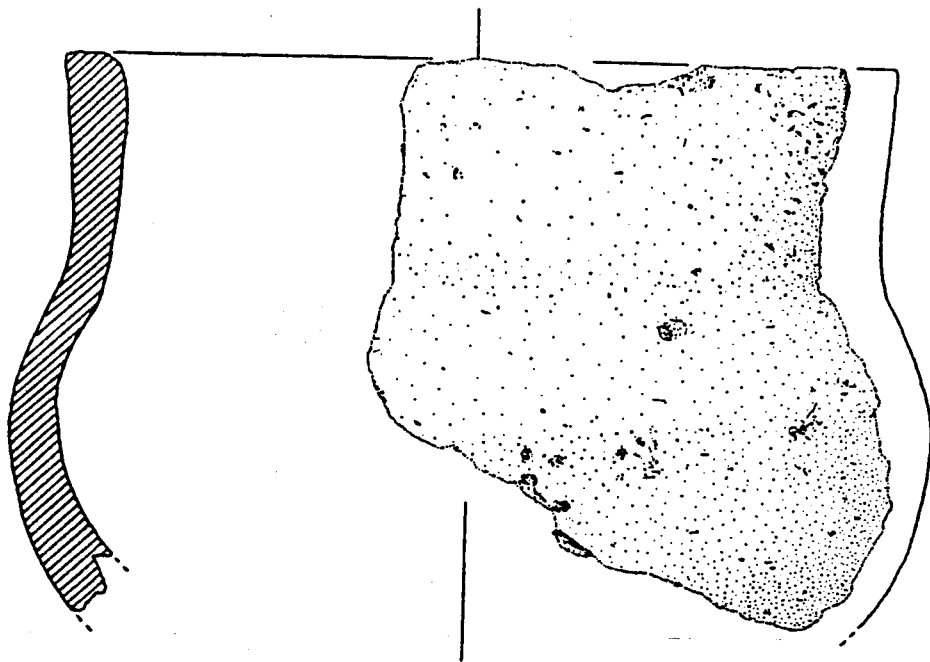

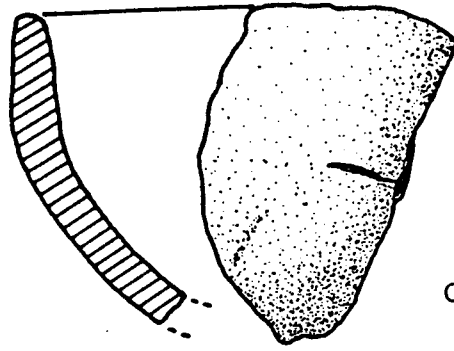

C 228

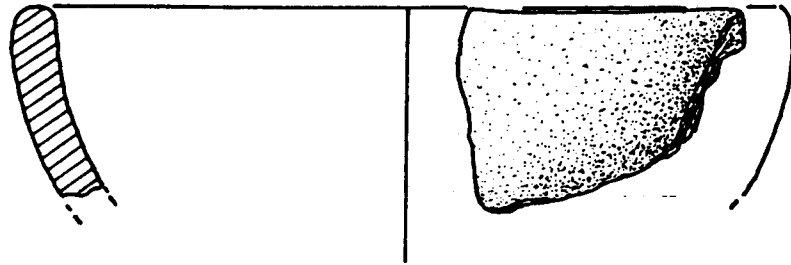

C 179

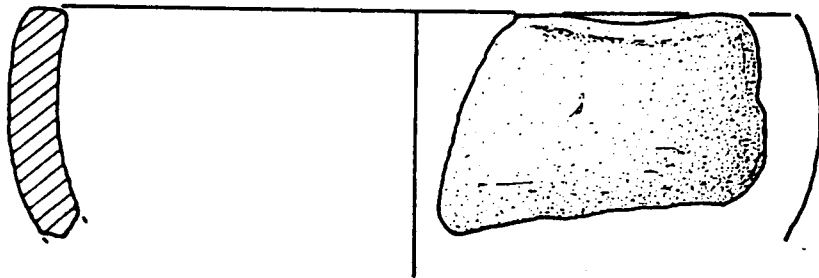

C 131

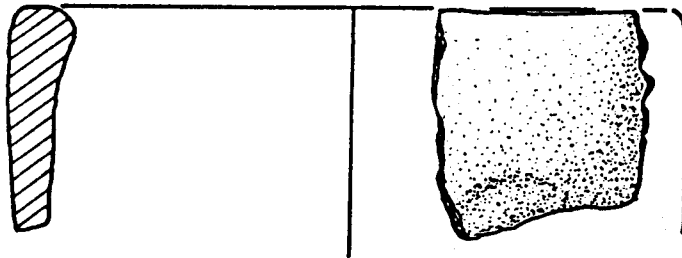

C 214



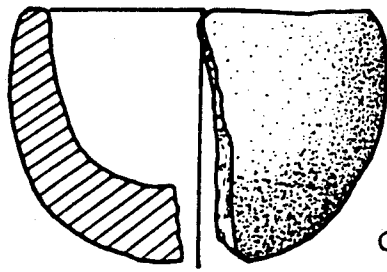

C181

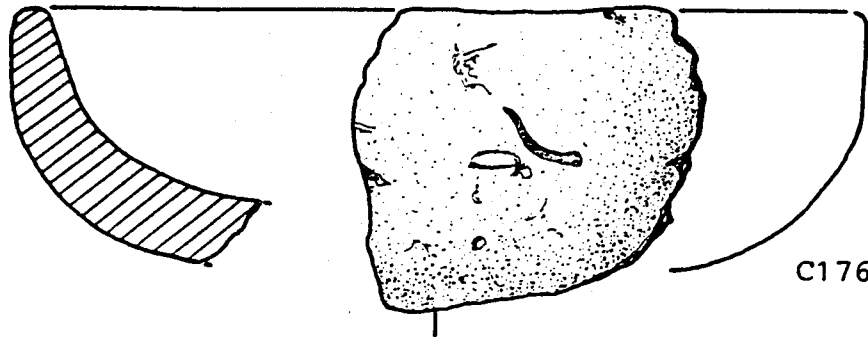

C176

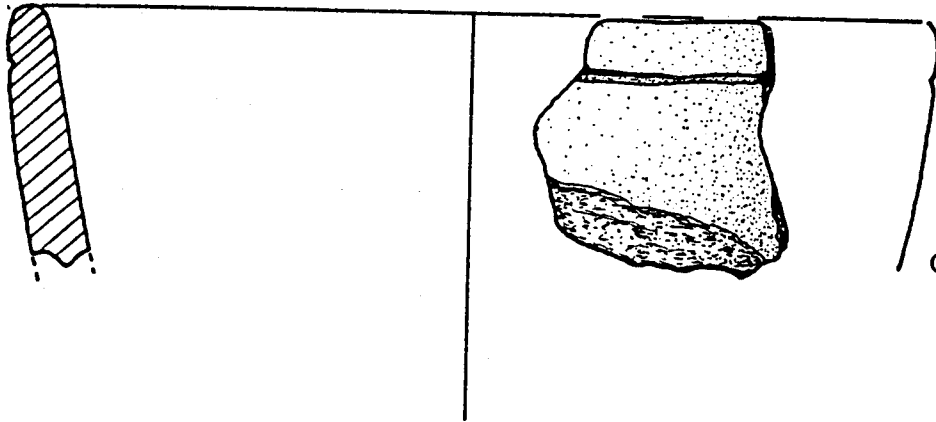

C155



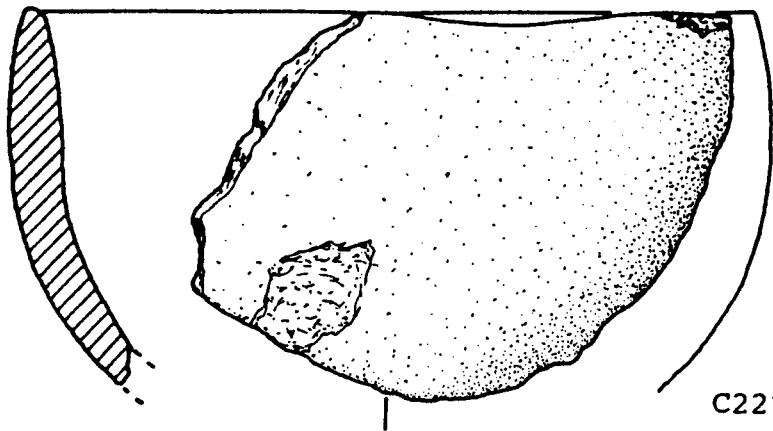

C221

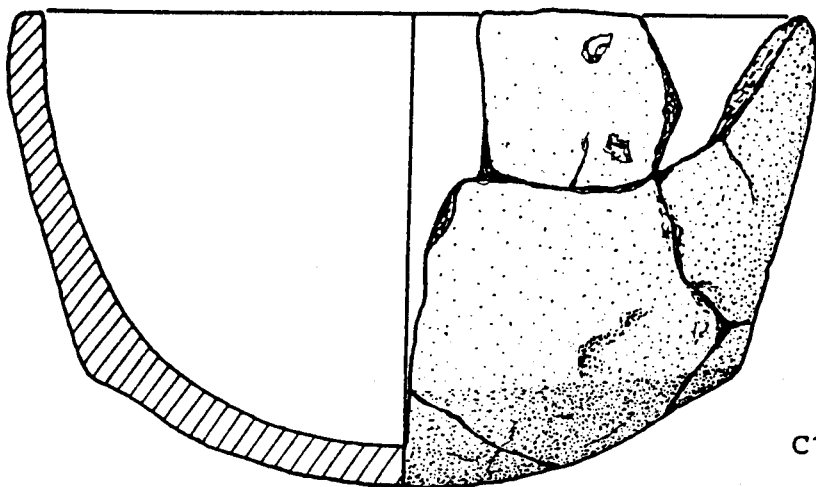

C143

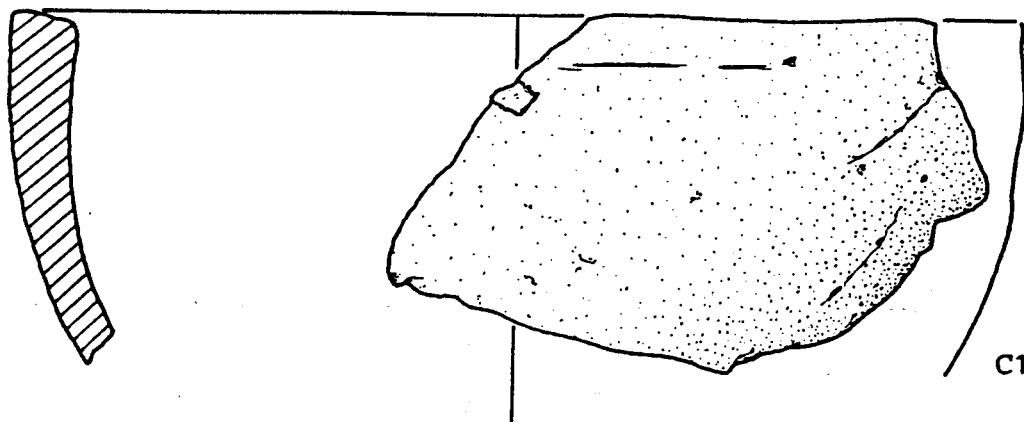

C178

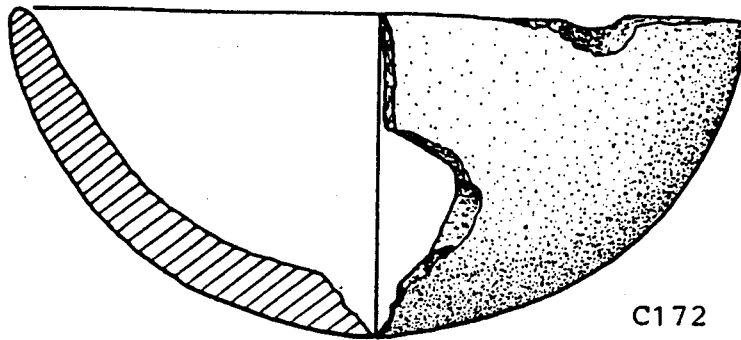

C172

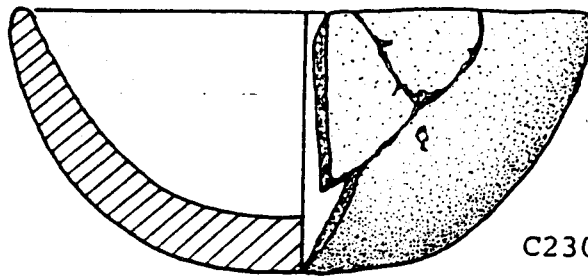

C230

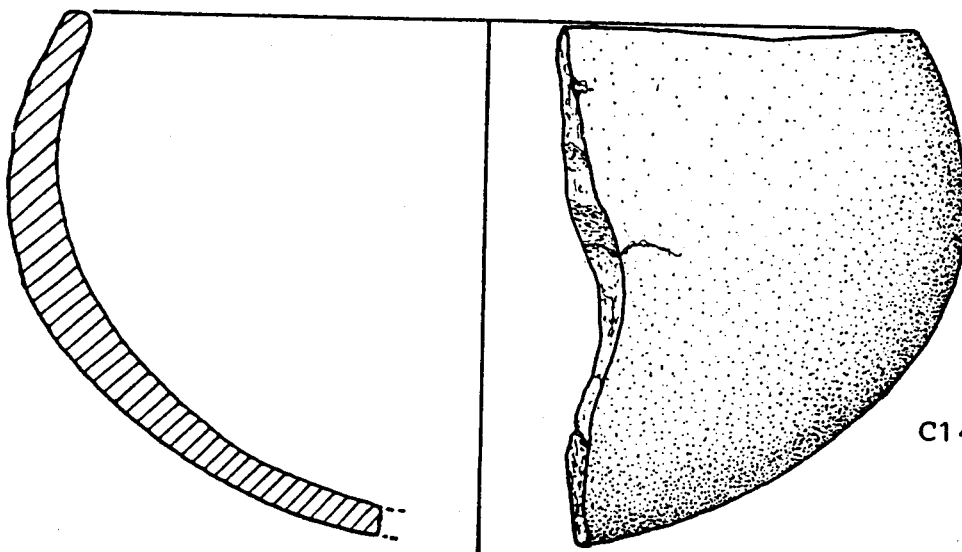

C140



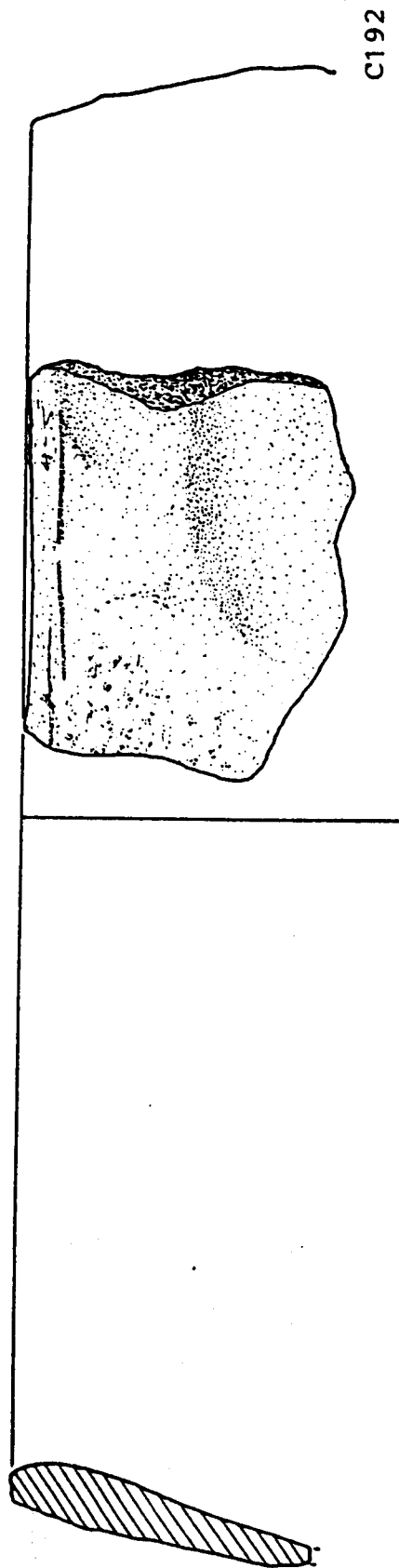
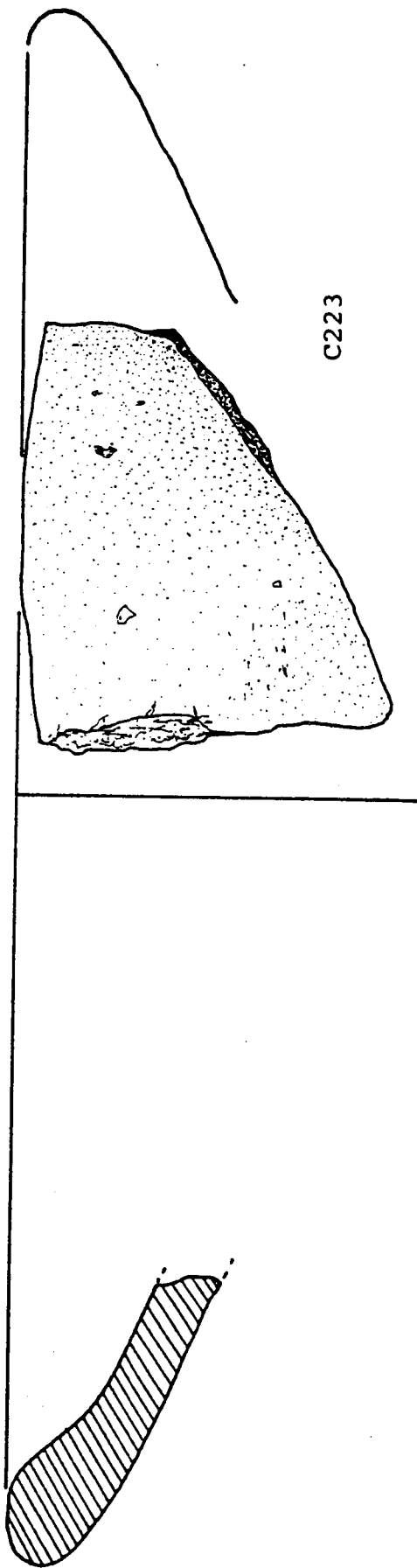



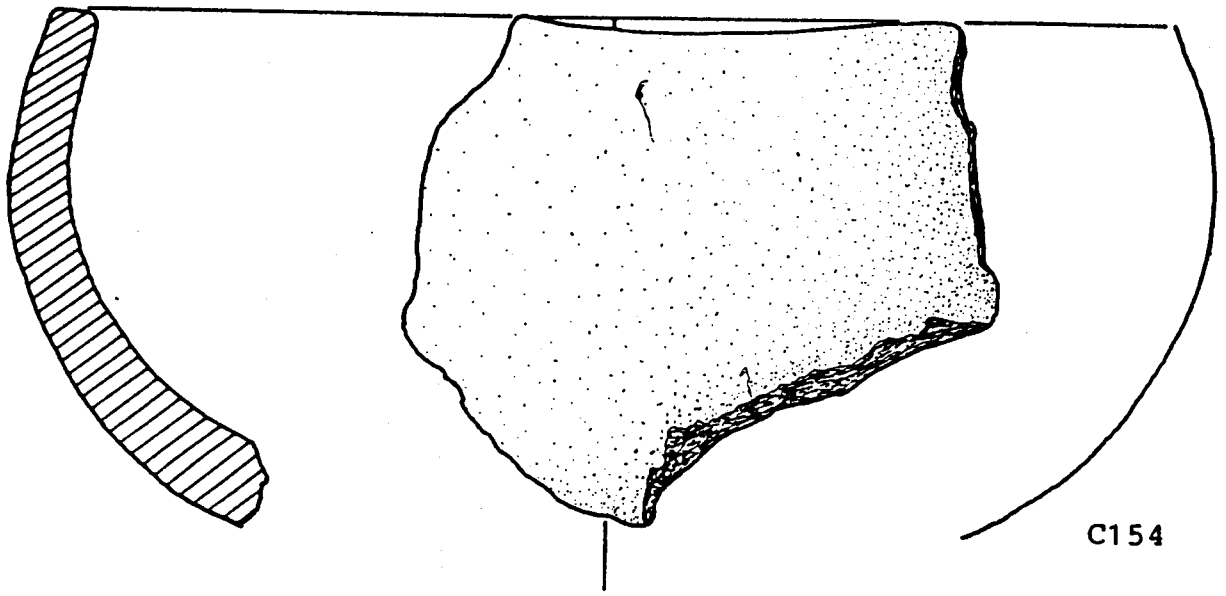

C154

C 198

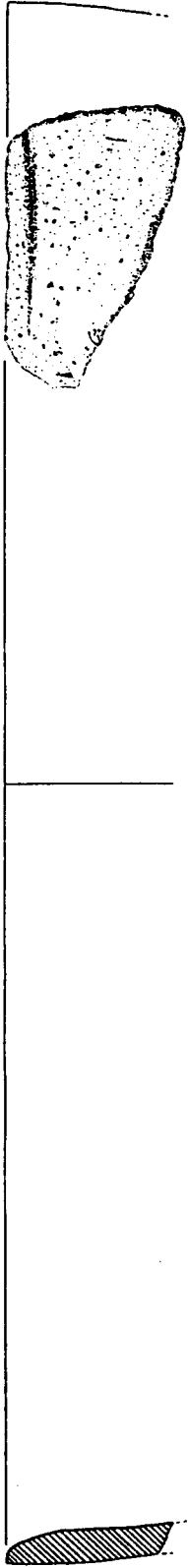

C 217

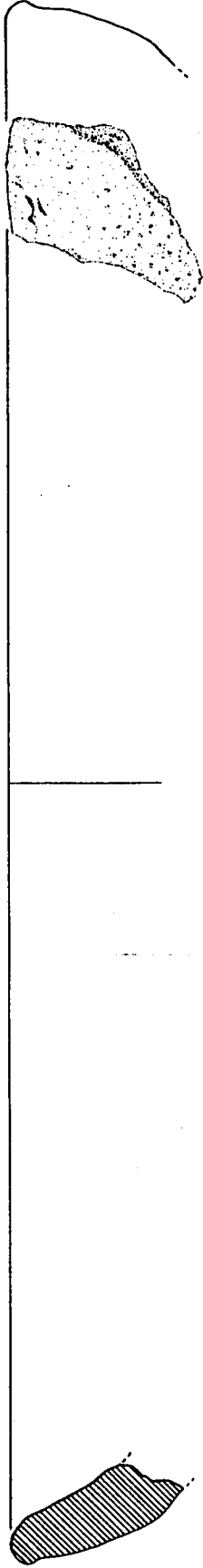

C 212

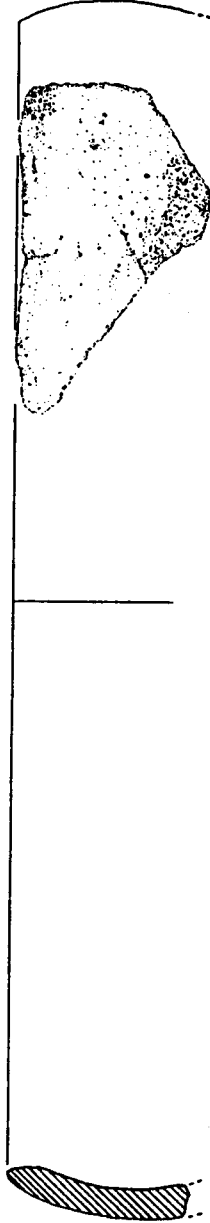

C 206

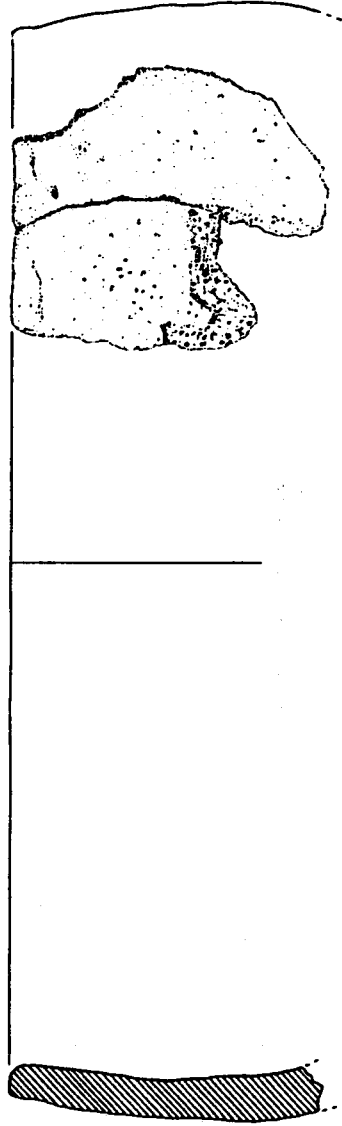

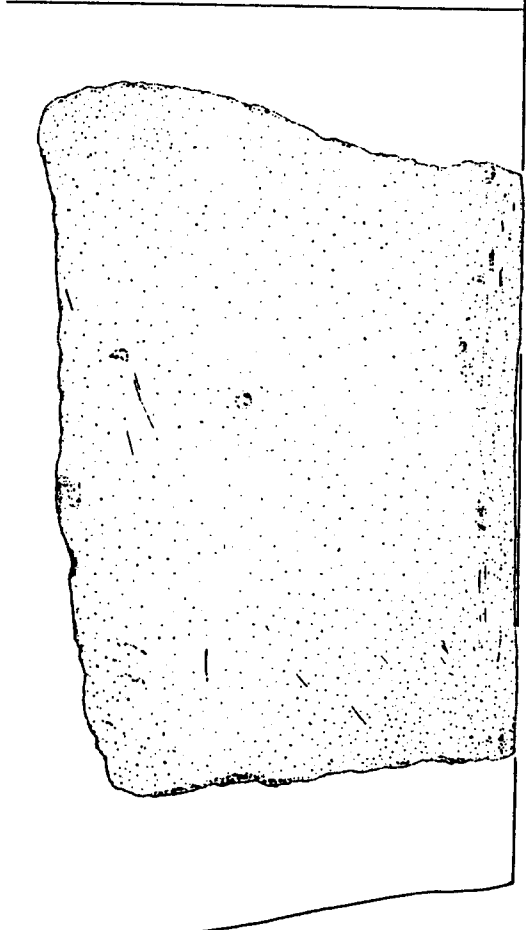

C 160

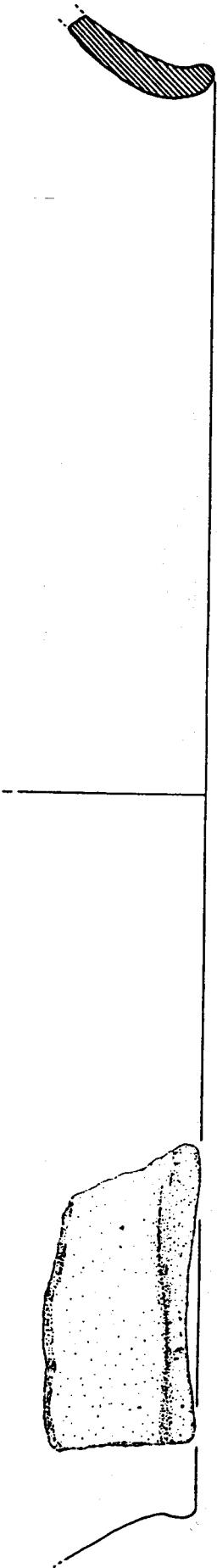

C 191

C 138

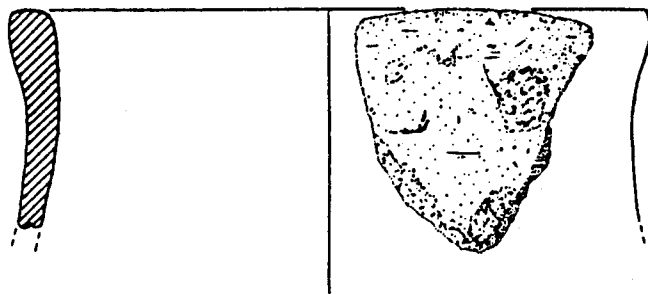

C 208

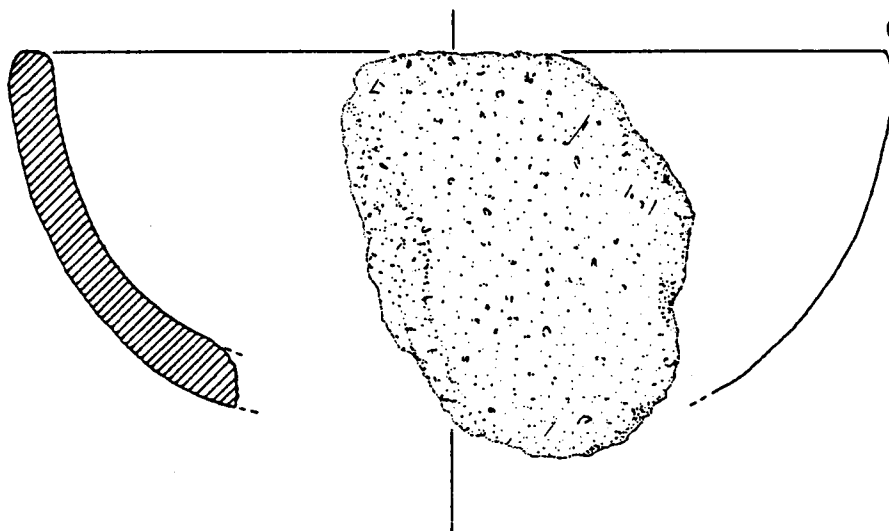

C 202

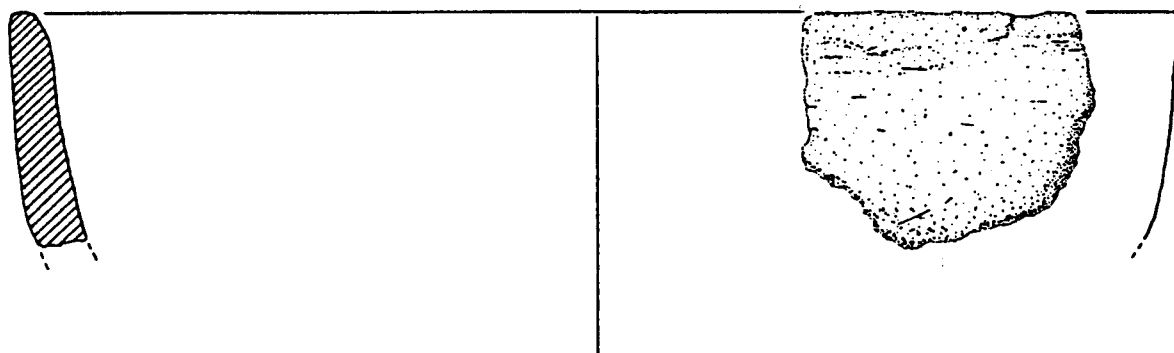

0 5 cm



C 180

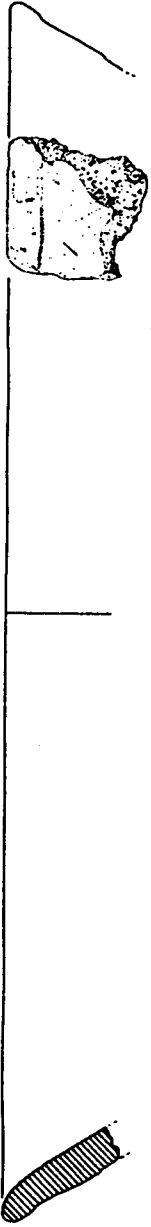

C 183

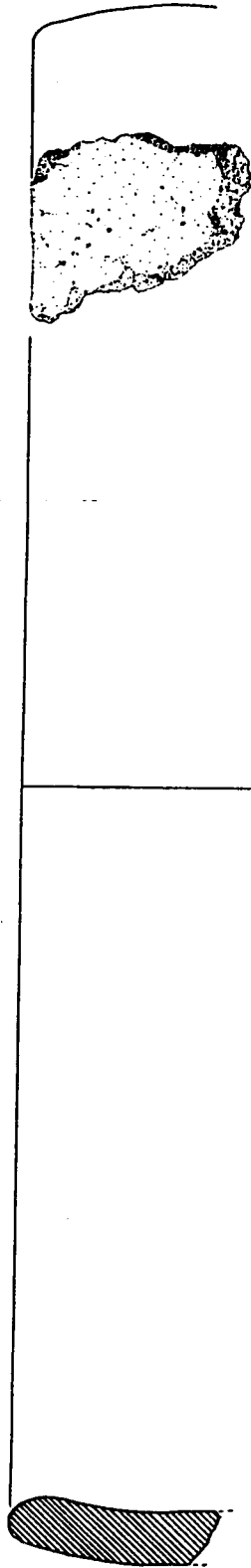

C 215

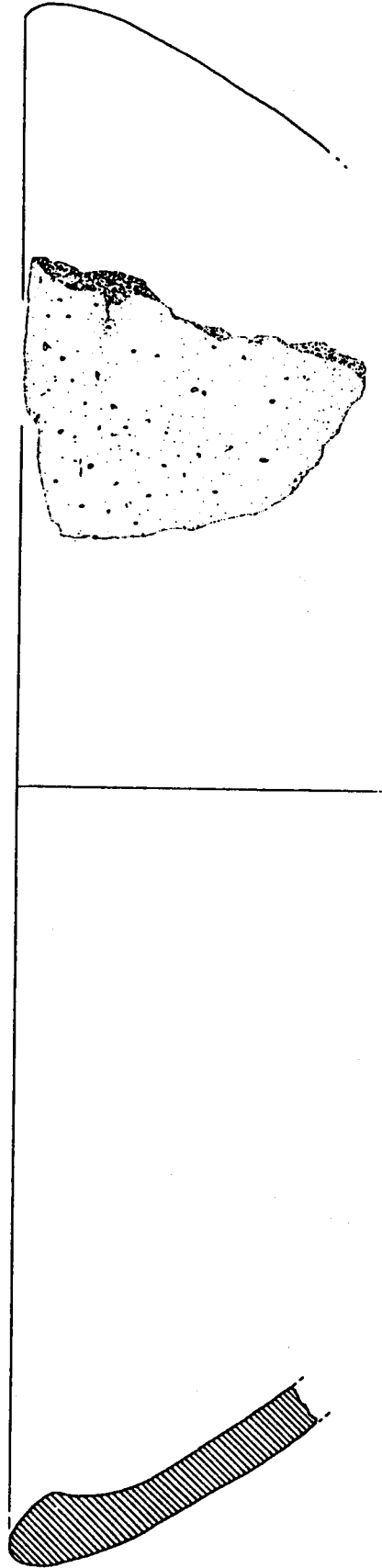

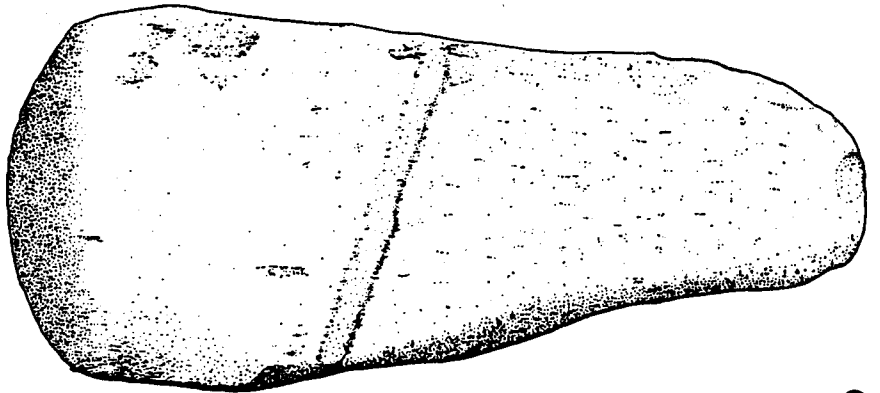
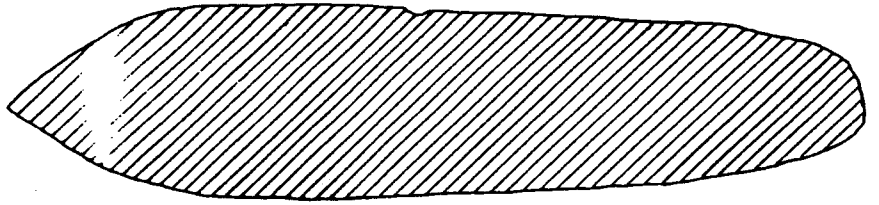
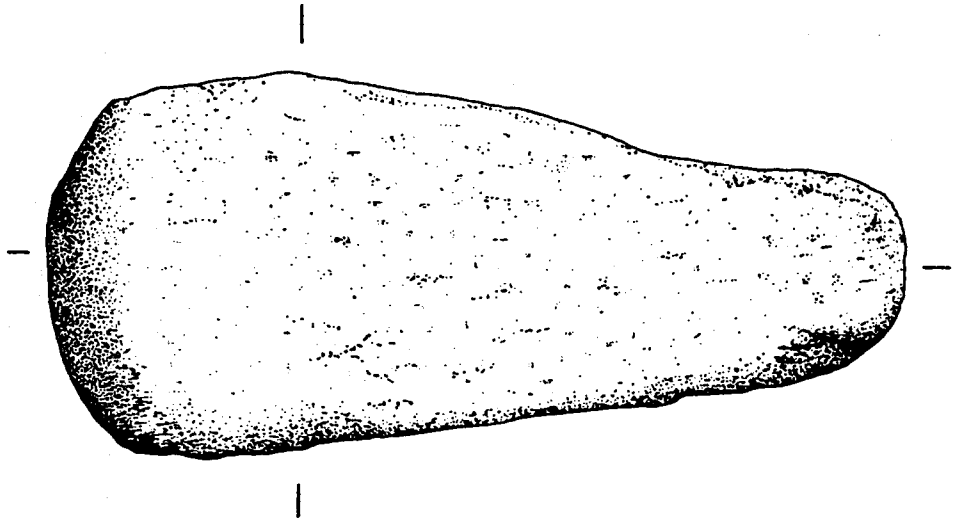
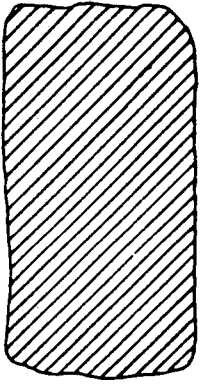

C 114

C 109

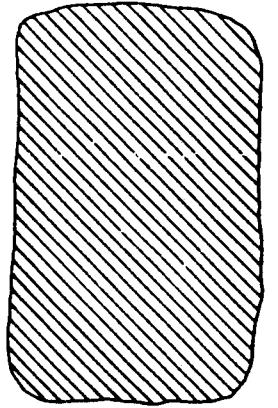
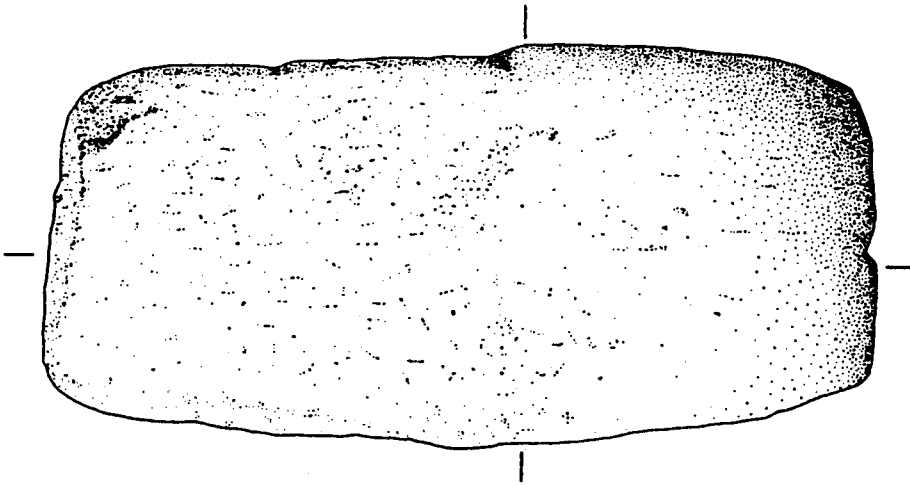
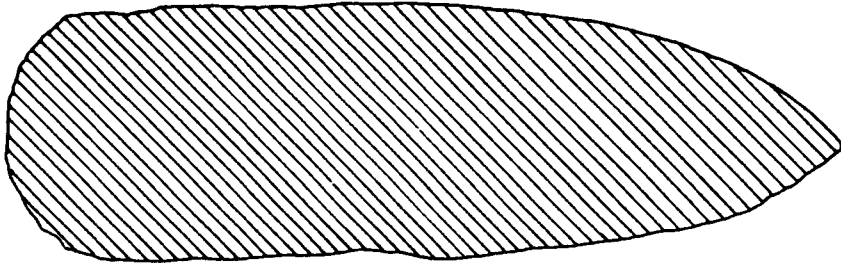
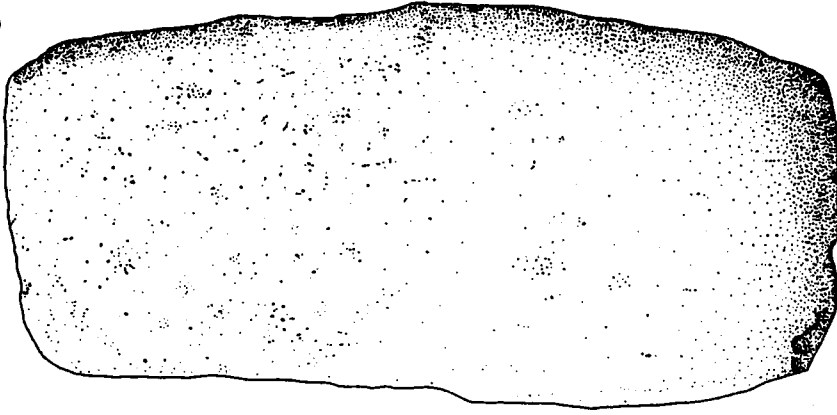



C 112

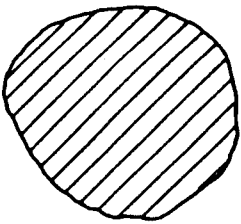
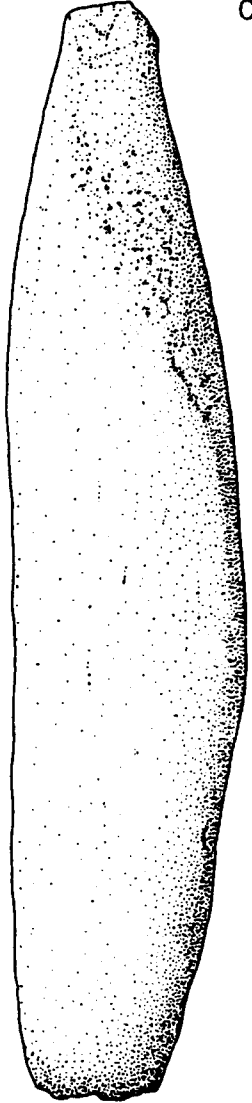
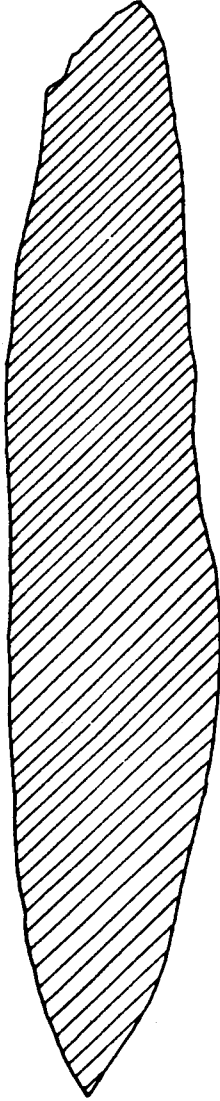

C 104

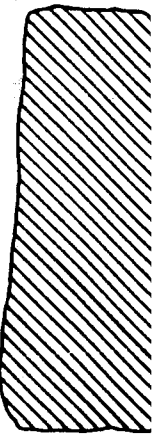
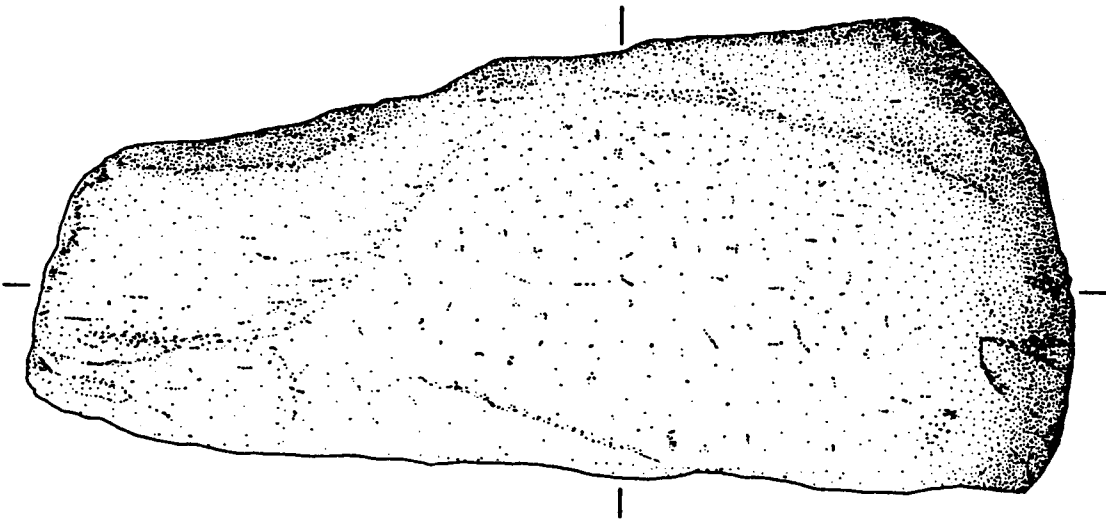
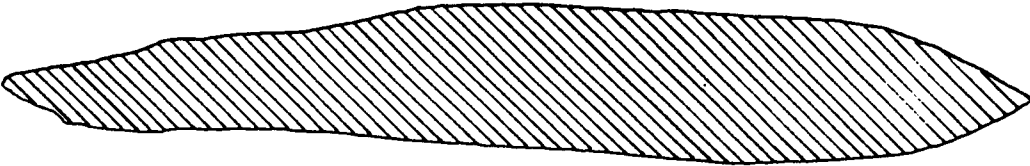
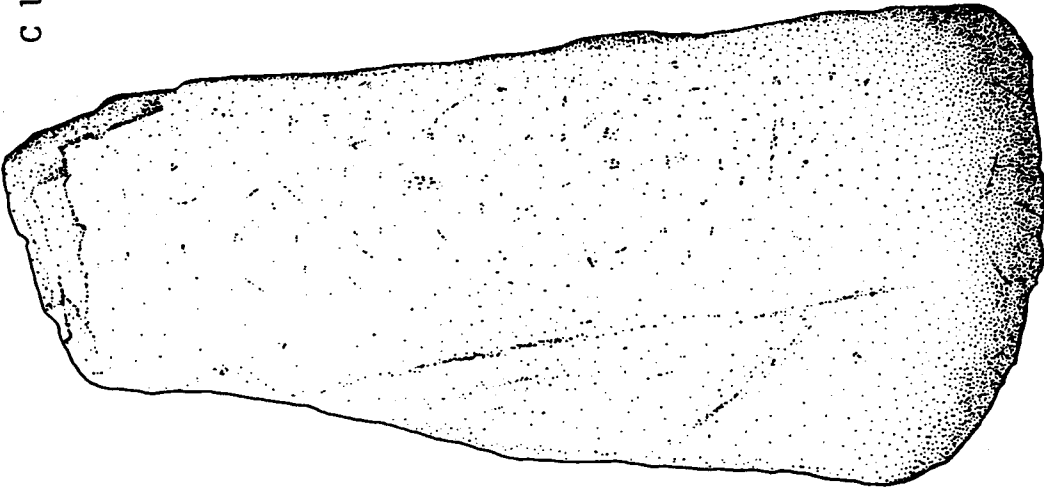

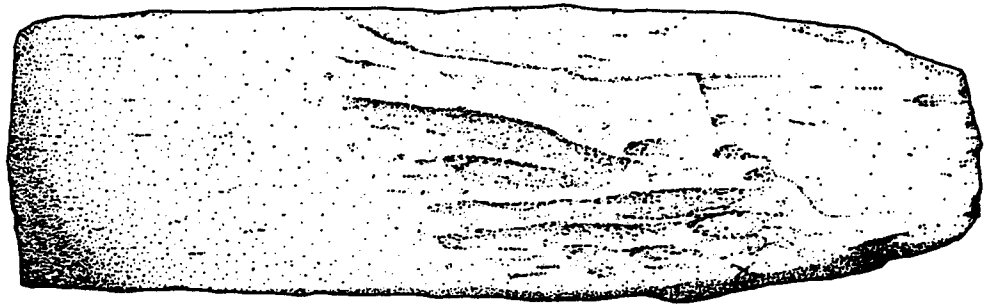
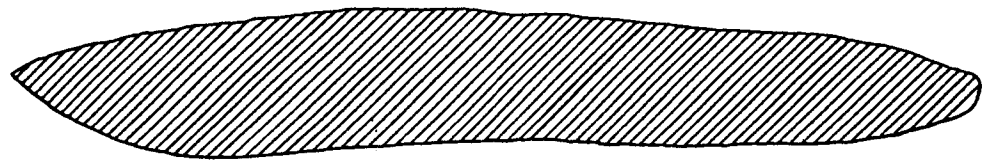
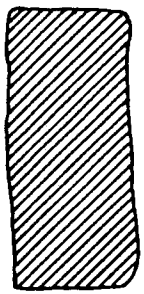

C115-A

C 110

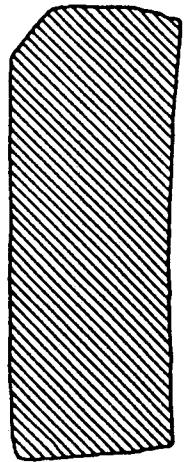
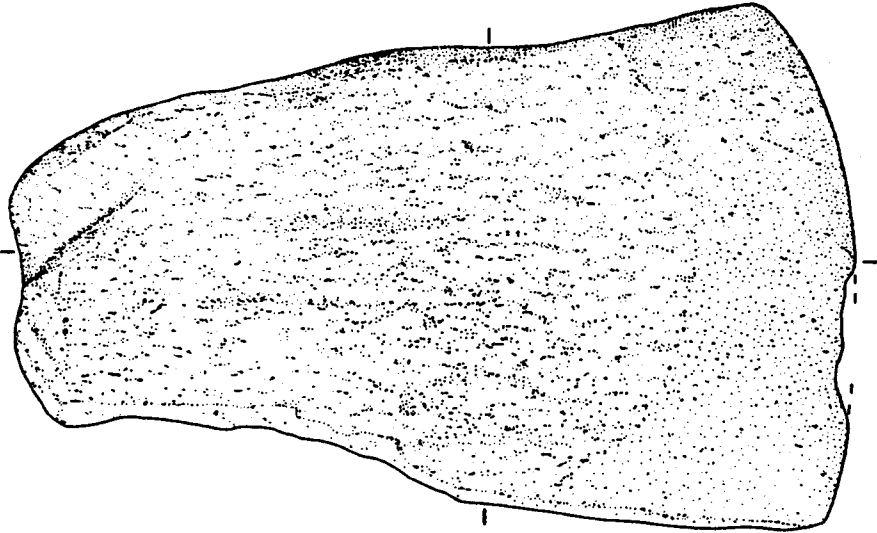
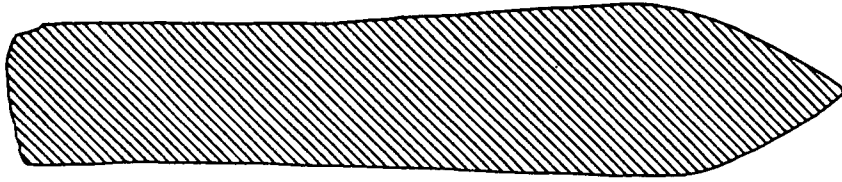
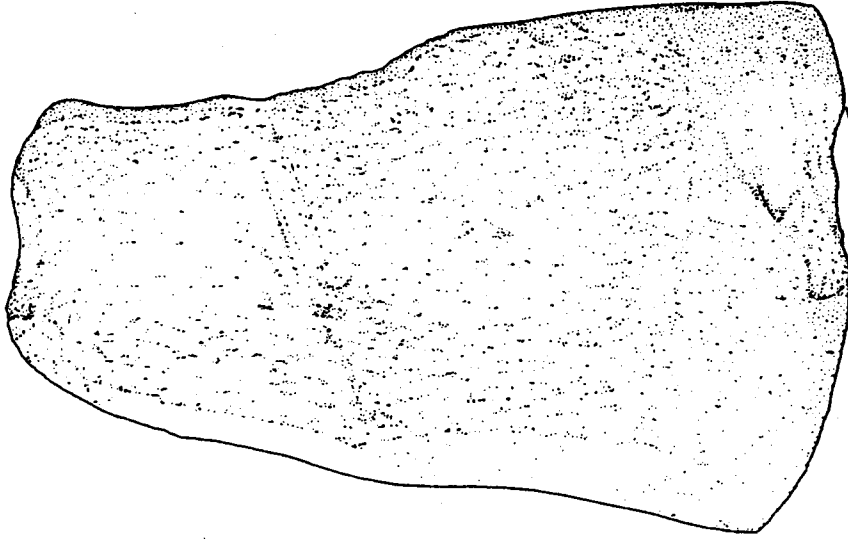

C 101

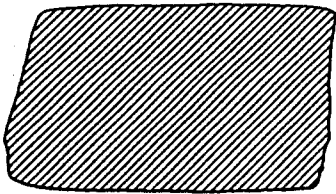
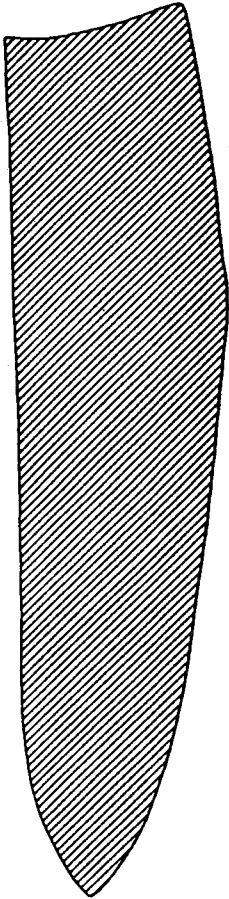

0 5 cm

C 115

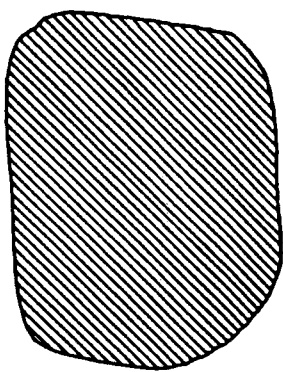
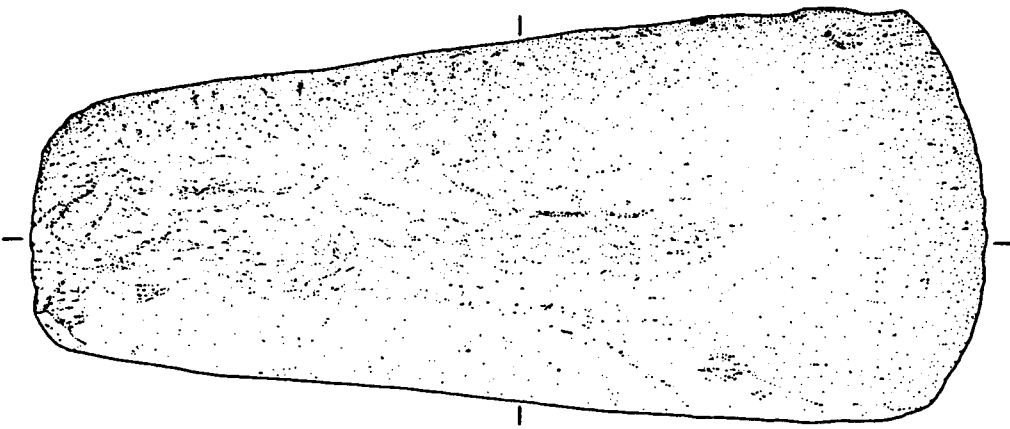
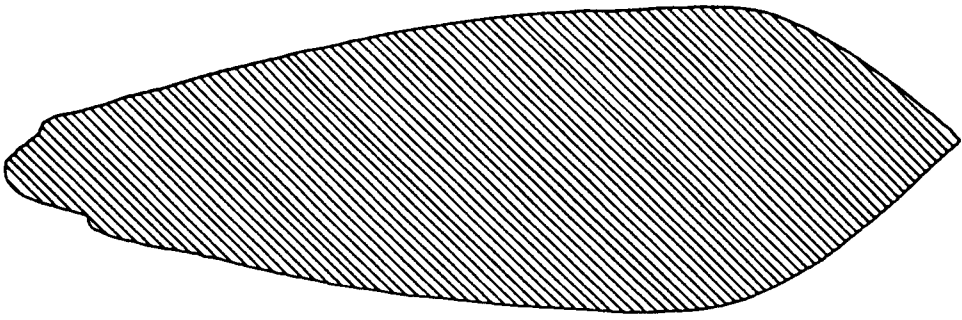
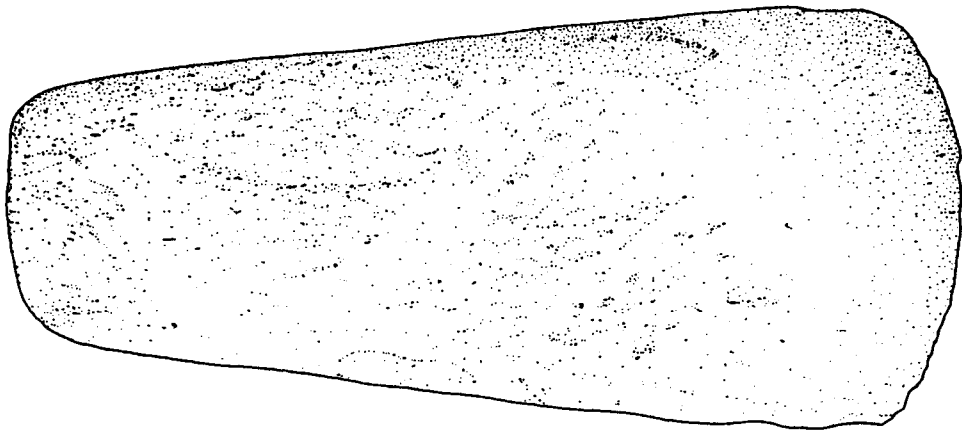

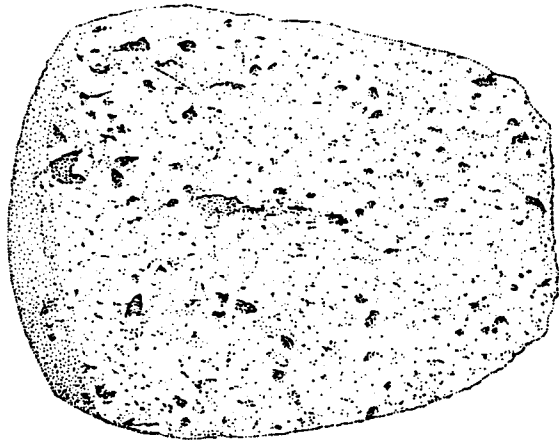
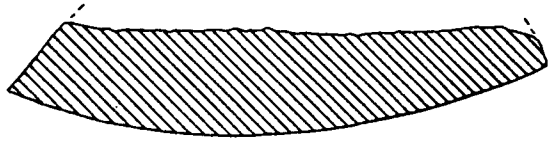
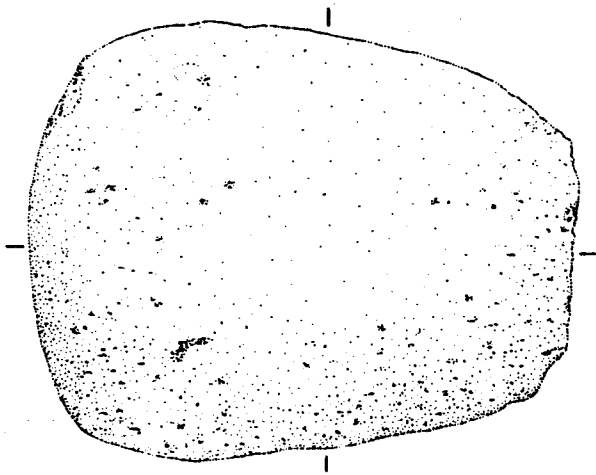
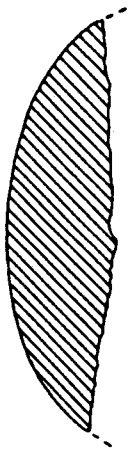

C 102

C 39

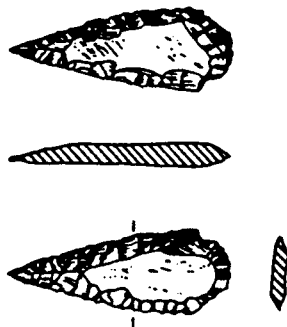

C 43

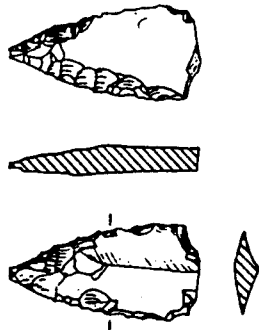

C 4

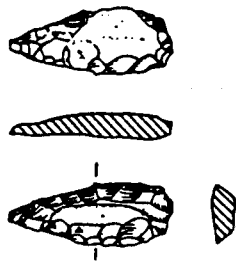

C 12

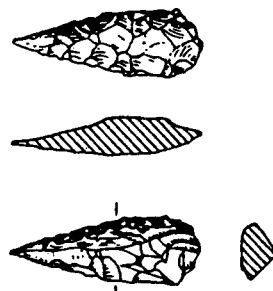

C 35



C 19

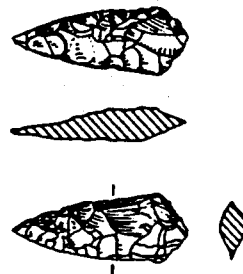

C 24





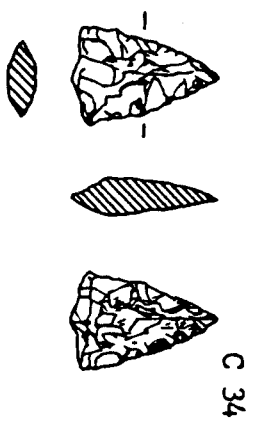
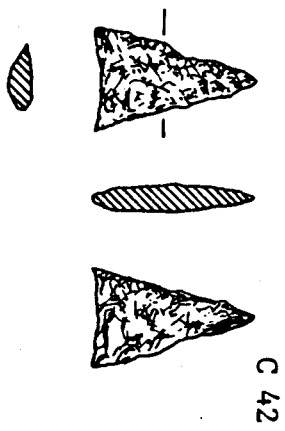
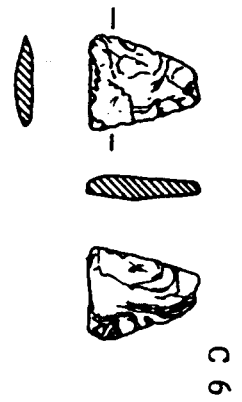
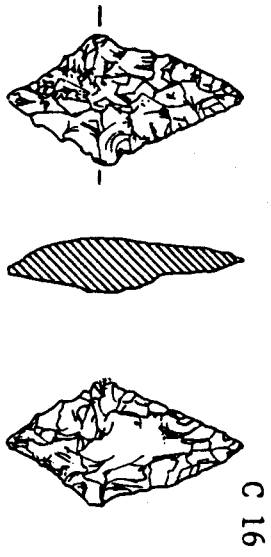
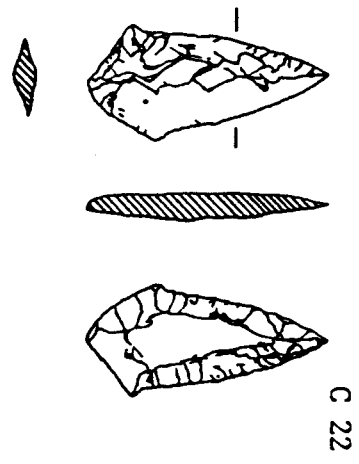

C 23

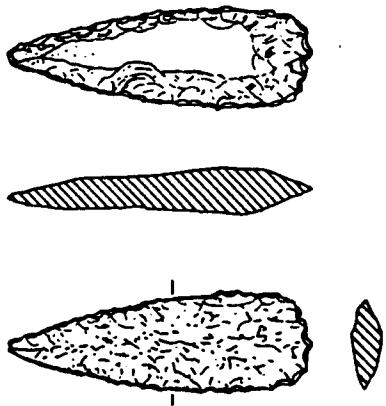

C 27

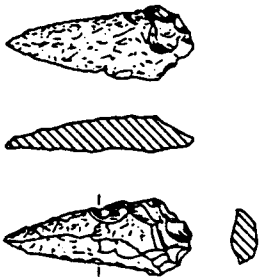

C 7



C 3

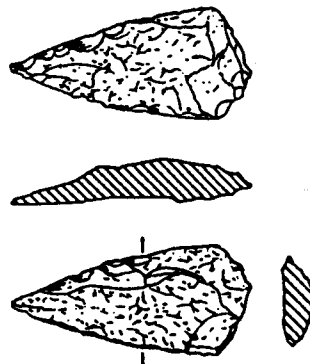

C 26

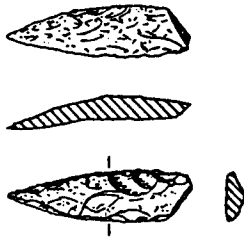

C 38

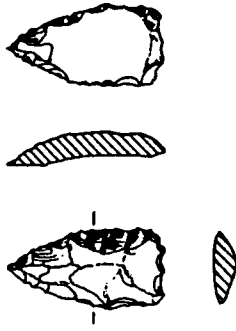

C 31

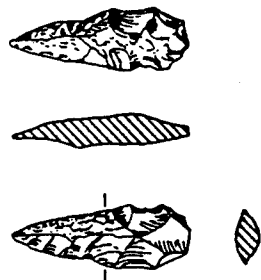

C 20

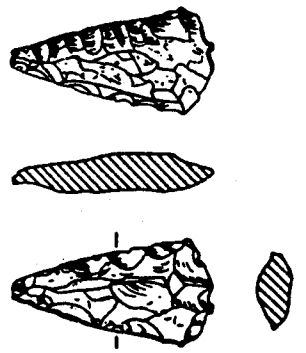

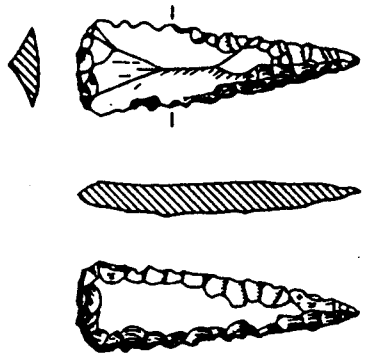

C 11

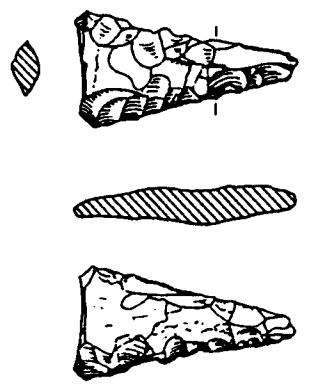

C 36

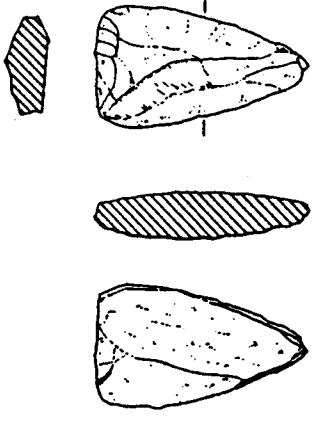

C 32

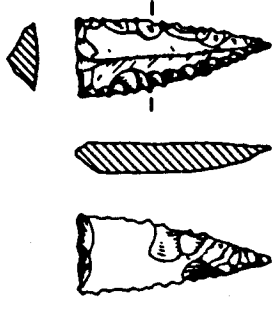

C 41

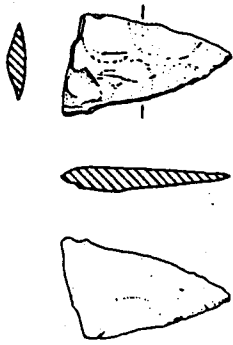

C 5

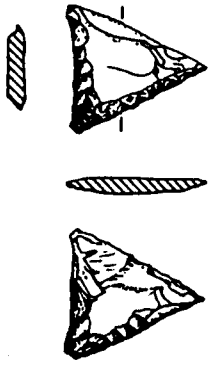

C 30

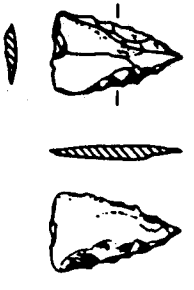

C 44



C 45



C9

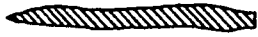

C8

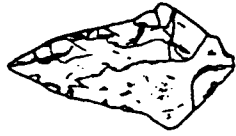

C1

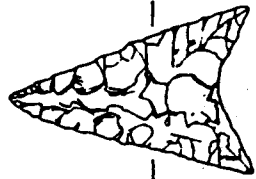
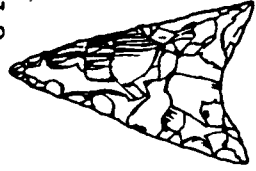

C18



C17



C33



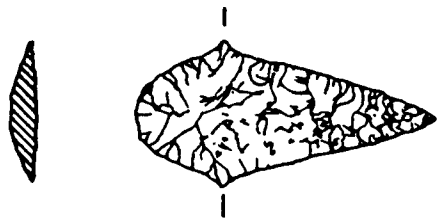

C 13

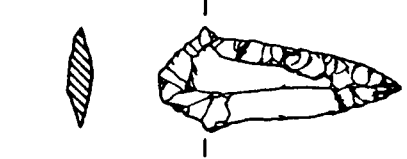
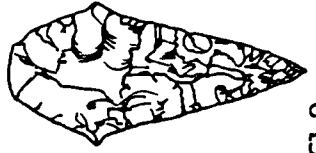

C 2

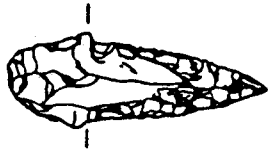

C 37



C 21



C/113

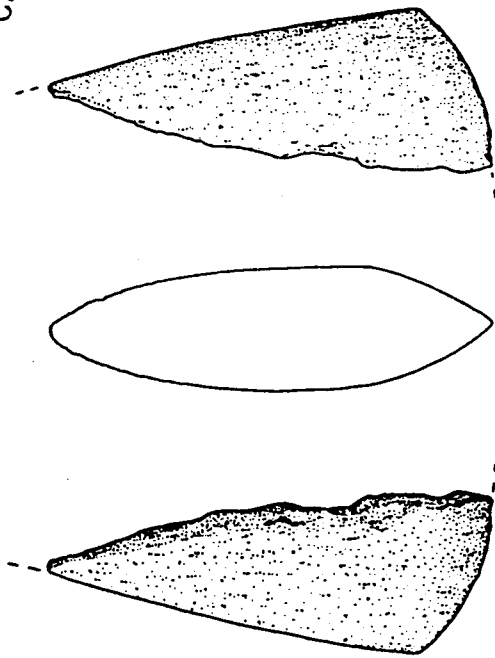

C/172

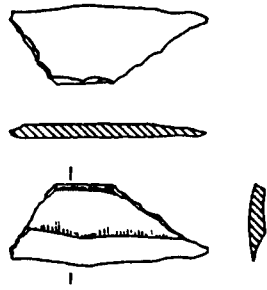

C/173

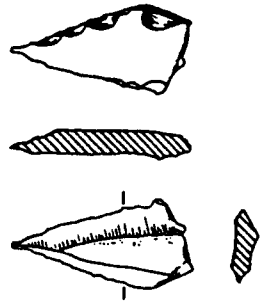

C/174

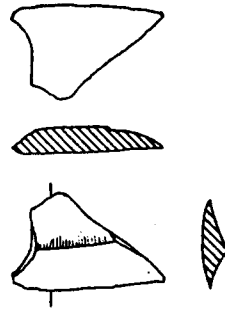

C/175

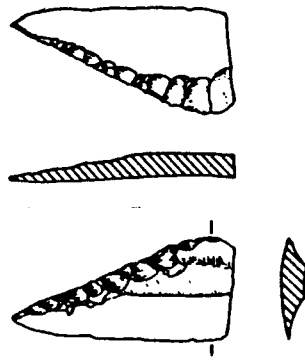

C/171

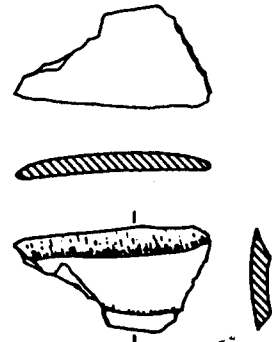

C/176

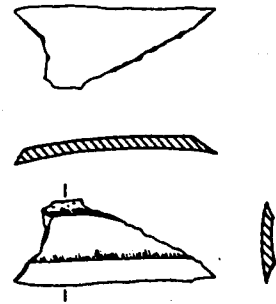

C/177

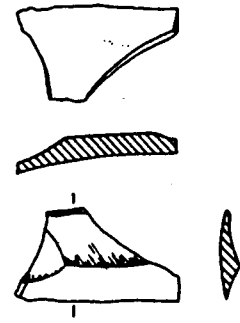

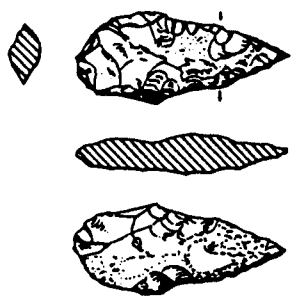

C 10

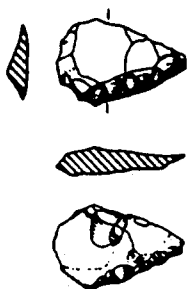

C 14

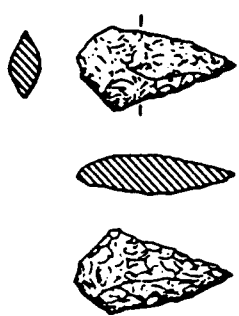

C 15



C 25



C 28



C 29

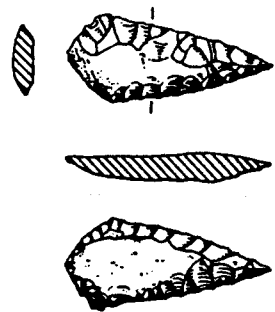

C 40

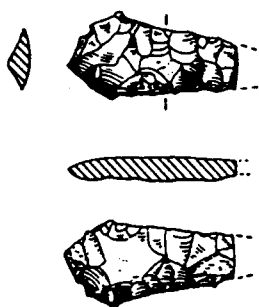

C 46

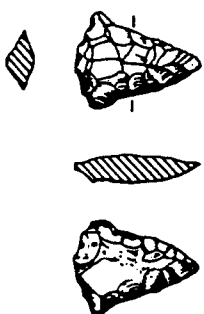

C 46A



C 87

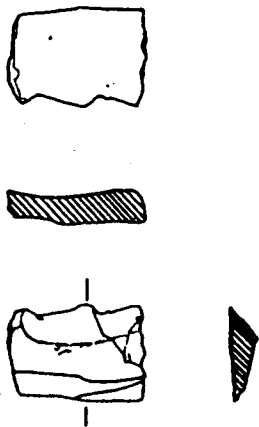

C 86

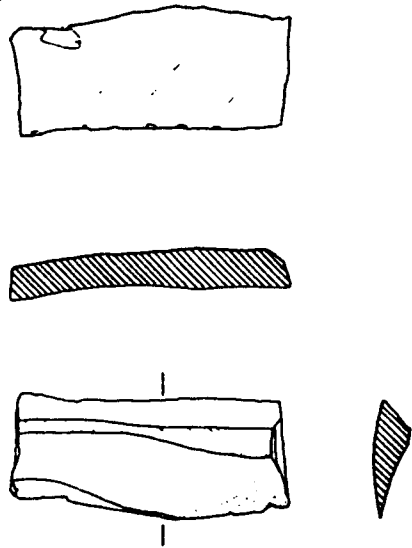

C 81

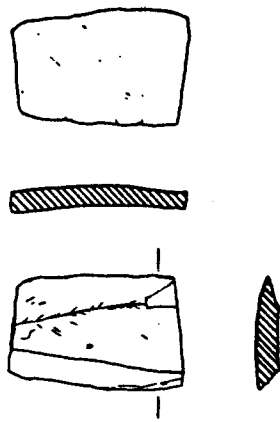

C 82

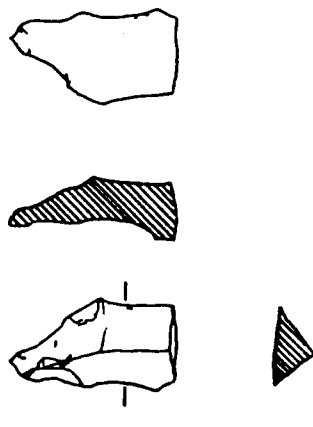

C 85

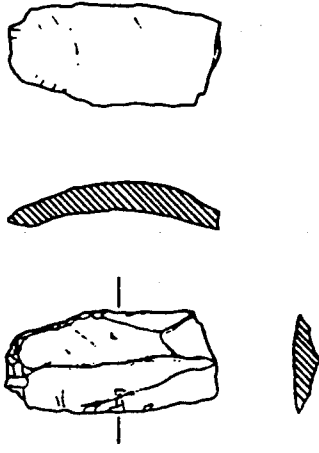

C 98

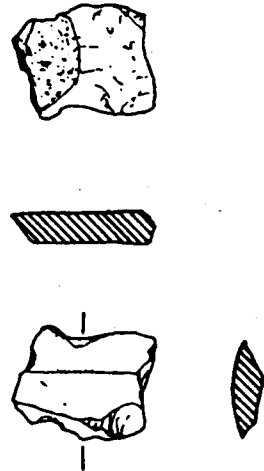

C 99

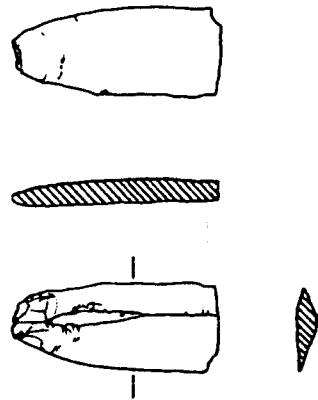

C 80

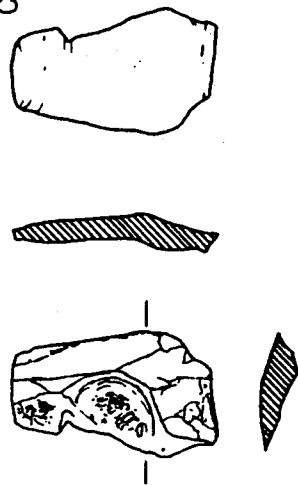



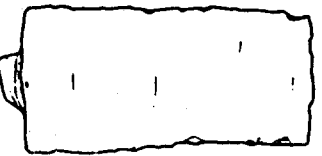
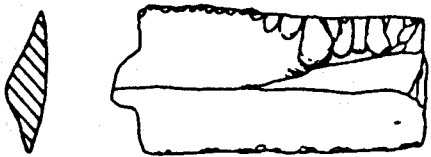

C 83

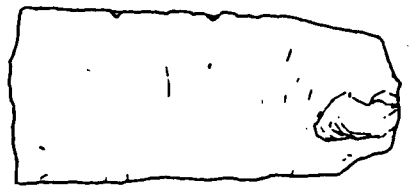
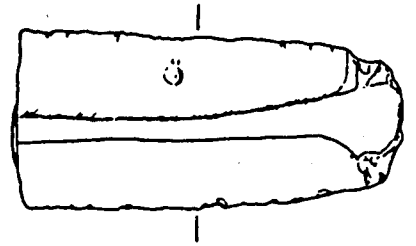

C 88

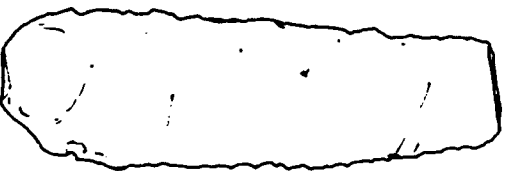
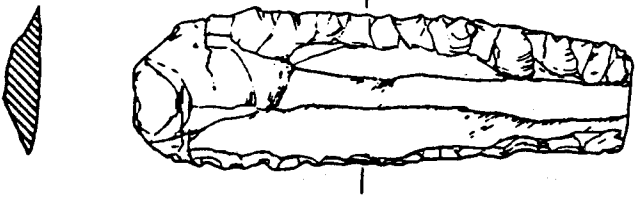

C 84

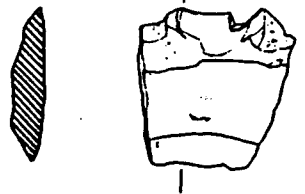

C 100



C 116

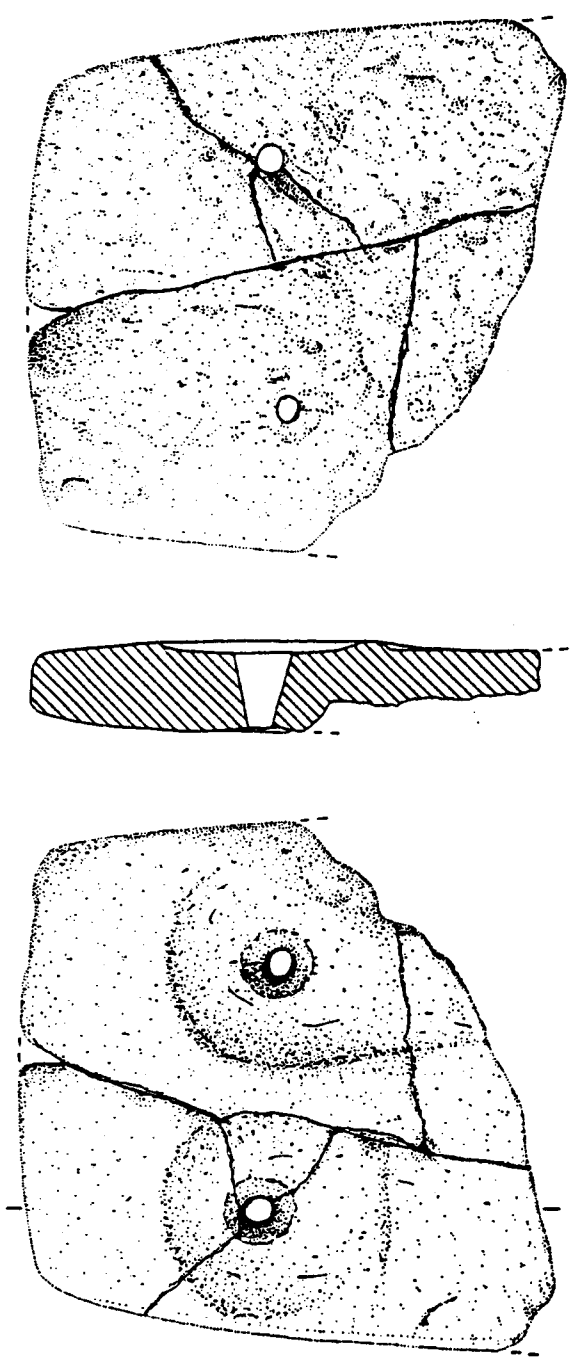

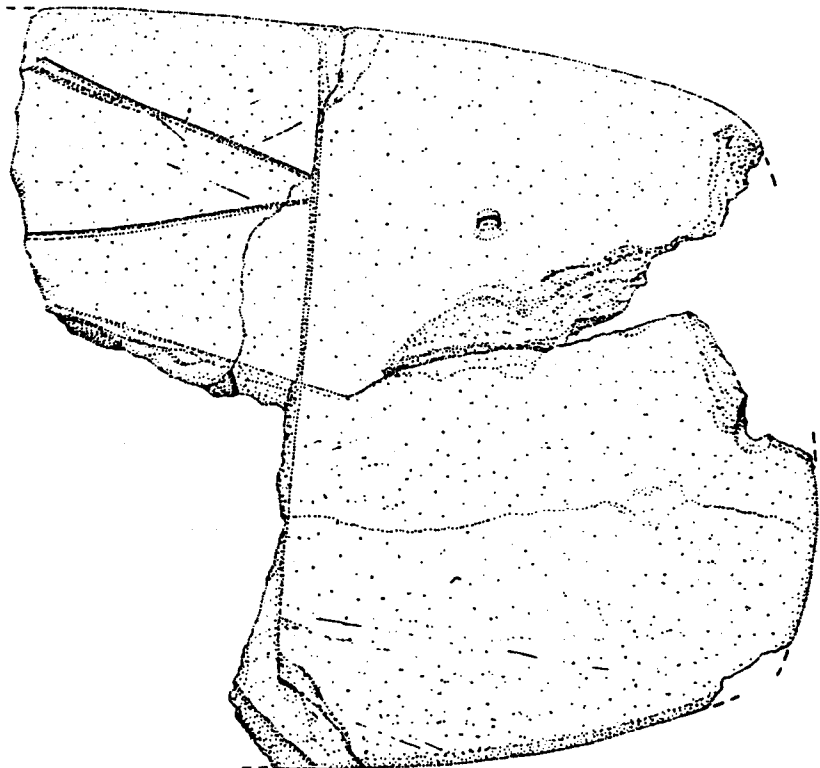
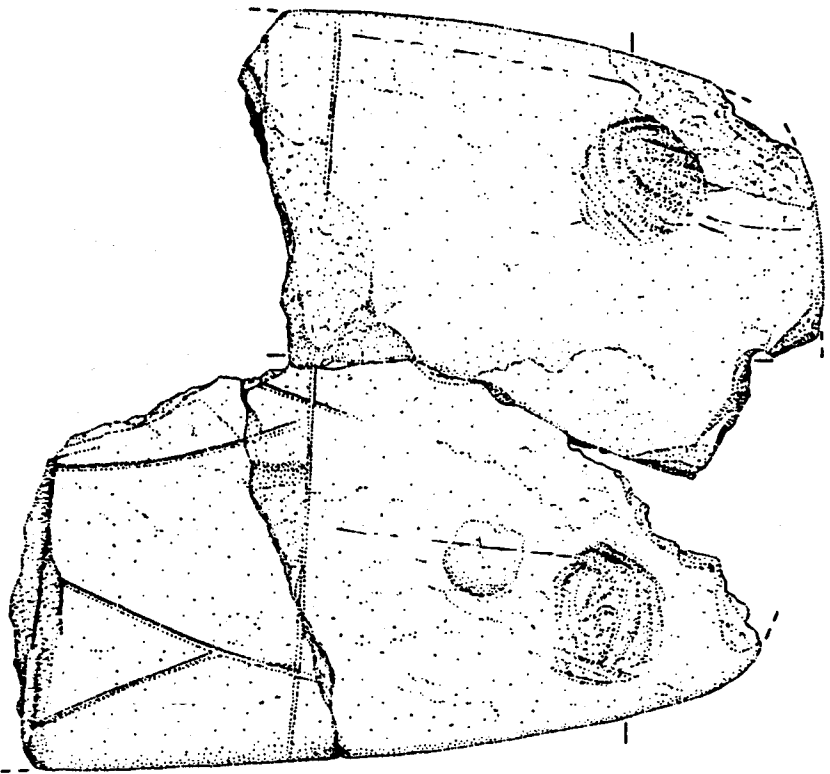

C 124

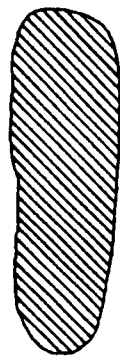
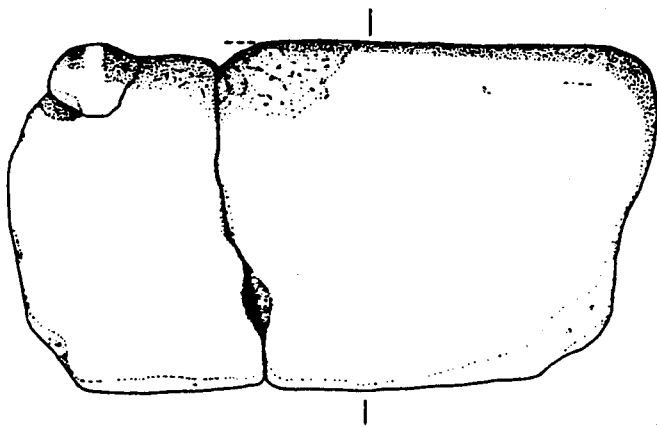
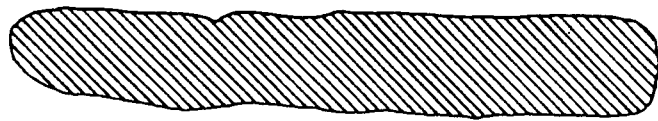

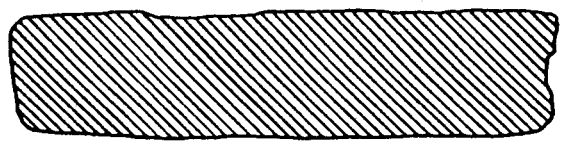
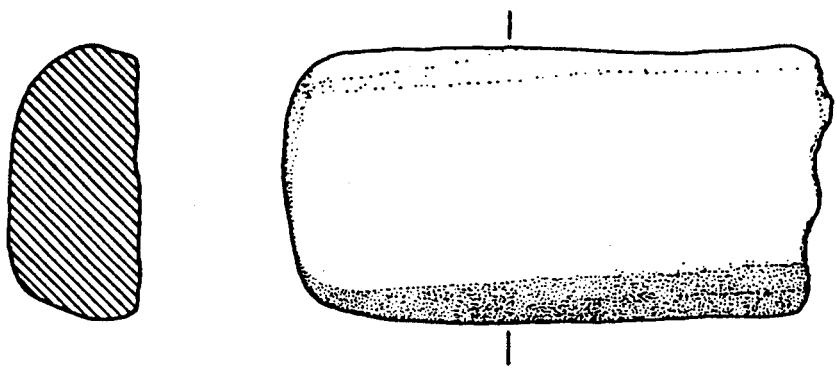

C 126

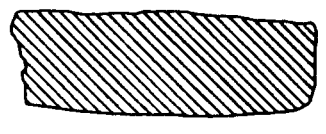
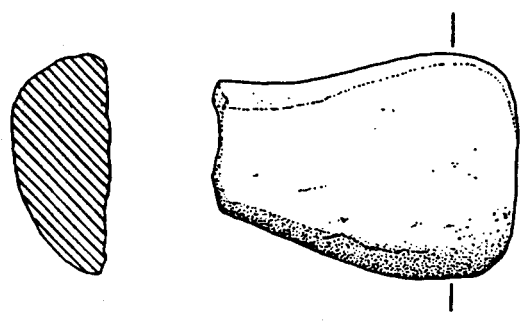

C 118



C/111

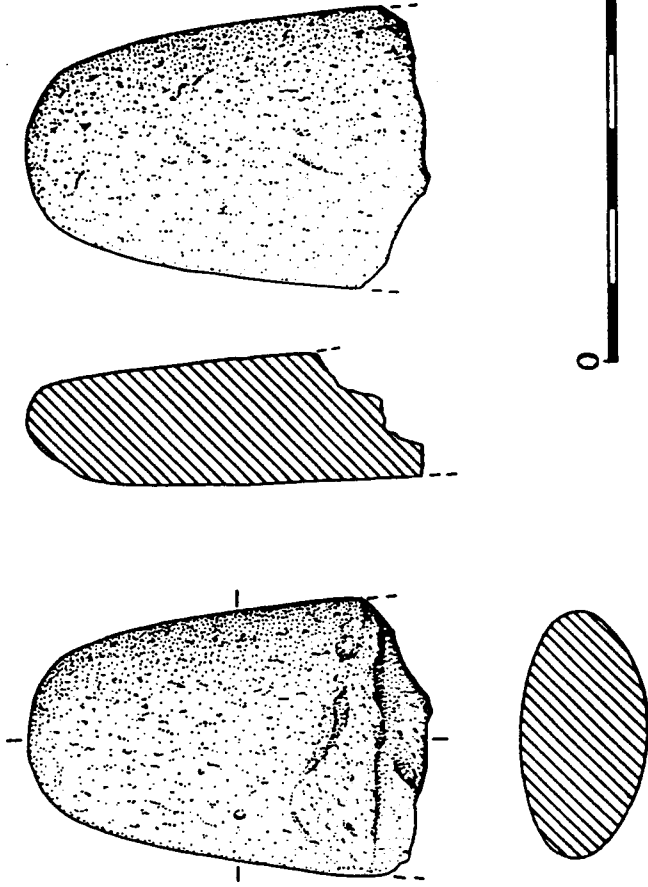

C/122

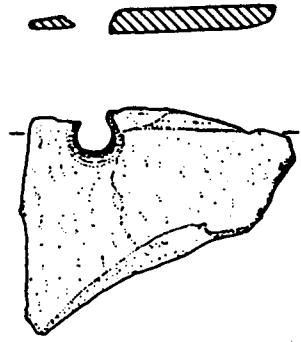

C/121

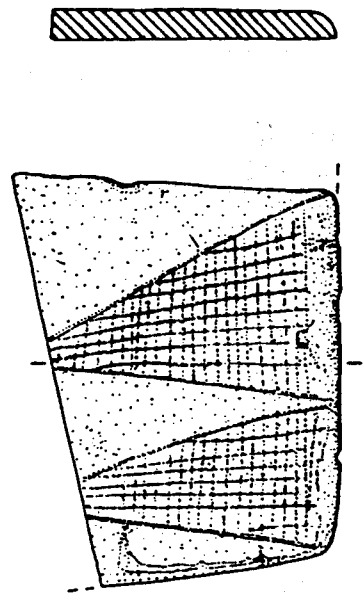

C/78

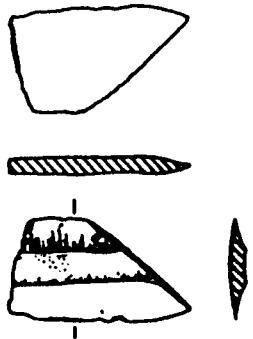

C/79

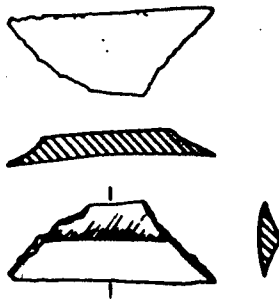

C/237

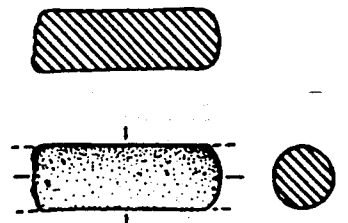

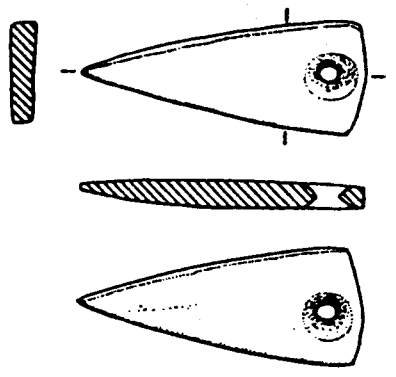

C/91-A

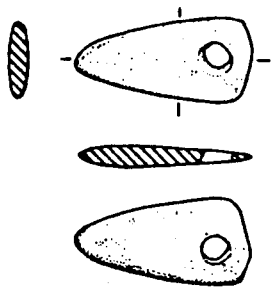

C/91

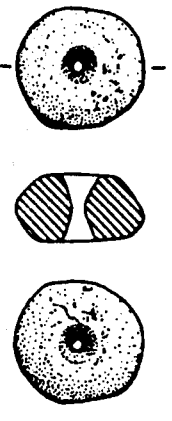

C/56

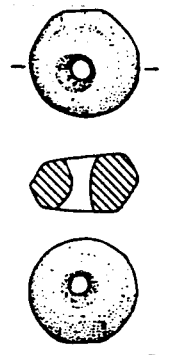

C/61

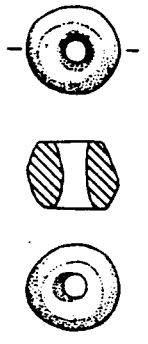

C/66

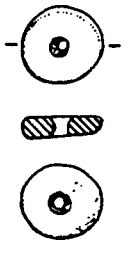

C/55

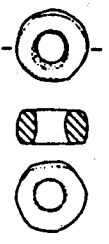

C/58

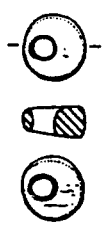

C/53

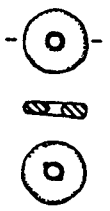

C/47

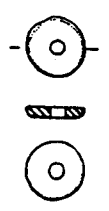

C/62

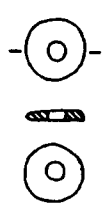

C/63

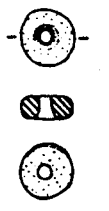

C/52

C/67

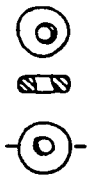

C/65

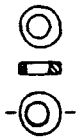

C/50

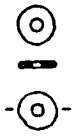

C/60

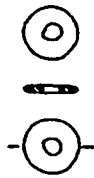

C/70



C/

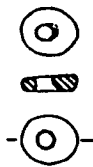

C/67



C/48



C/69



C/54



C/64



C/51

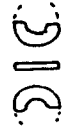

C/57





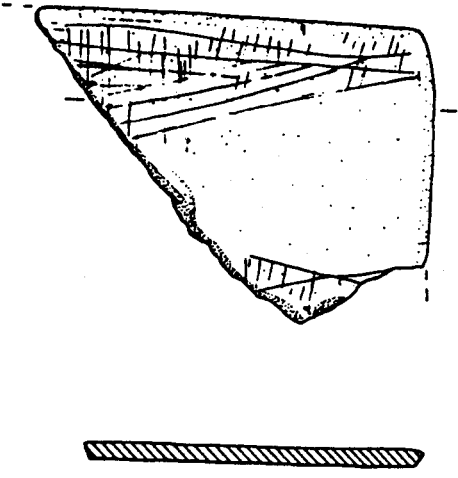

C 122

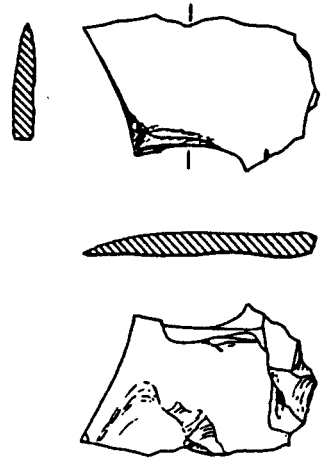

C 96

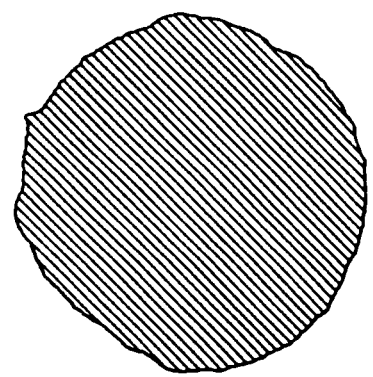
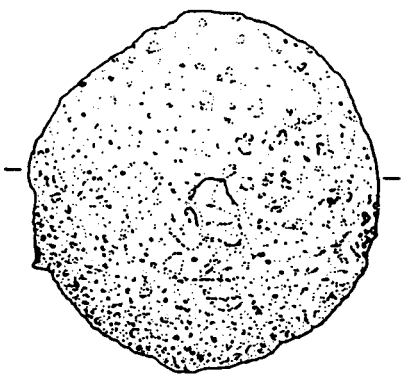

C 121

C 166

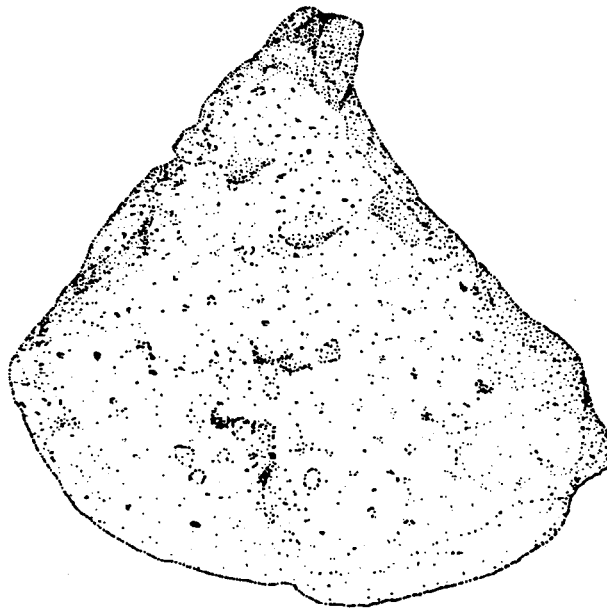
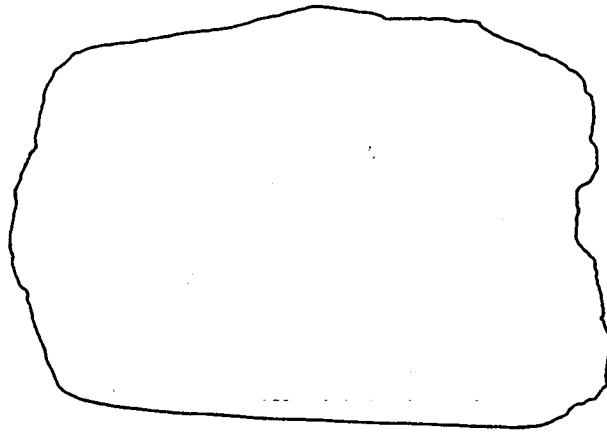
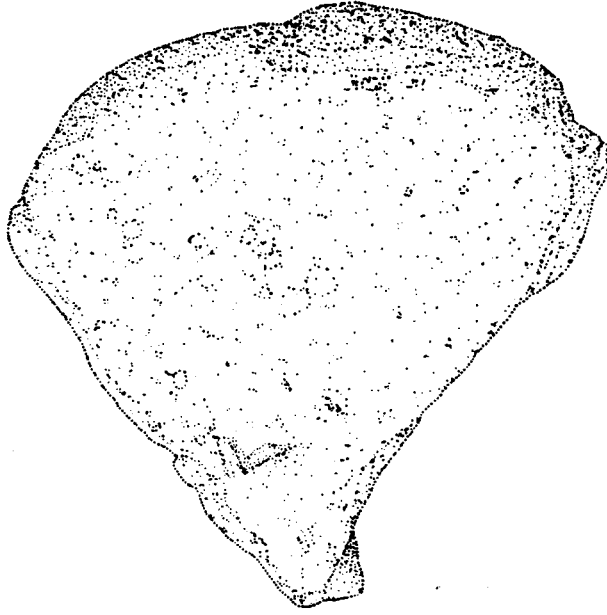

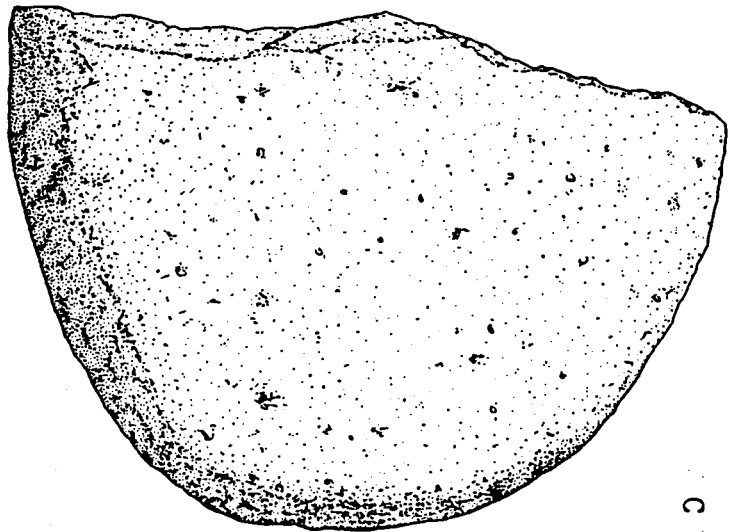
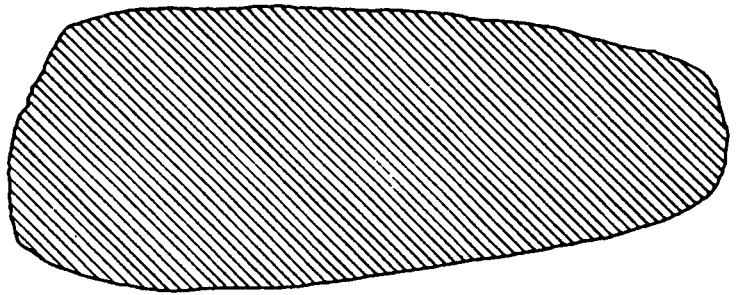
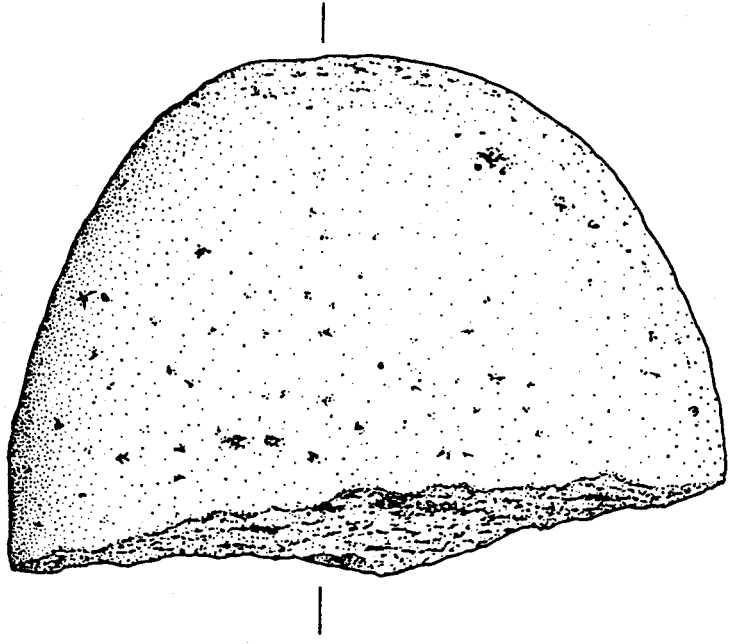
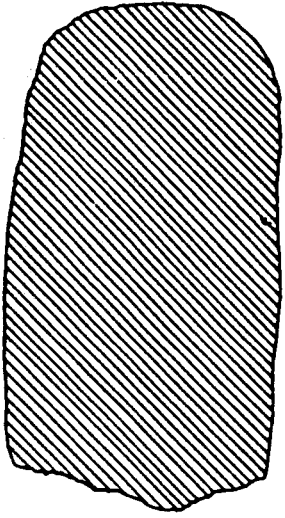

C 163

C 164

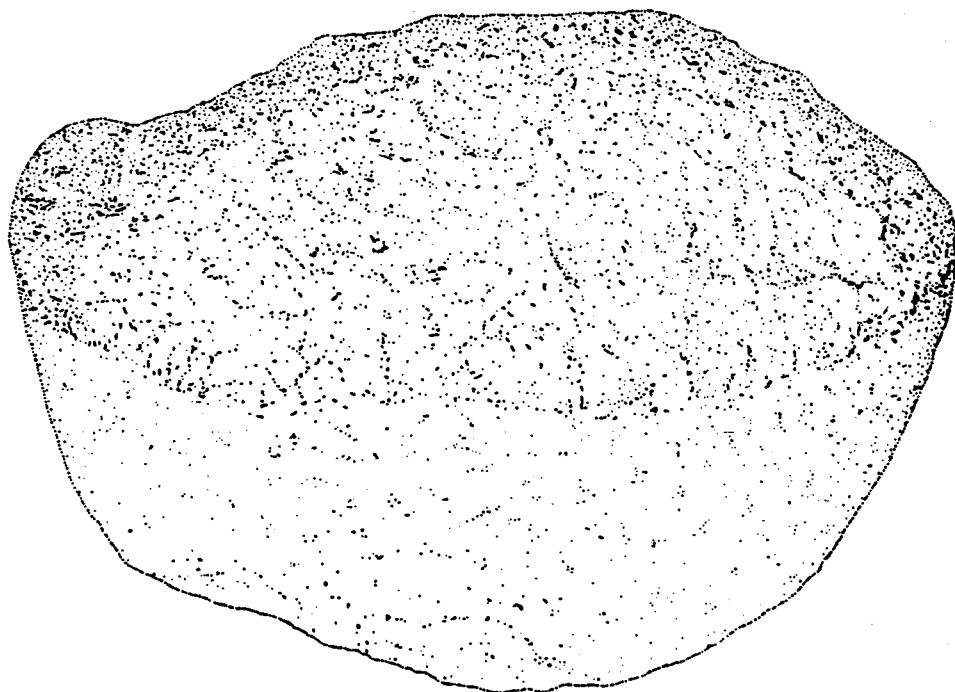
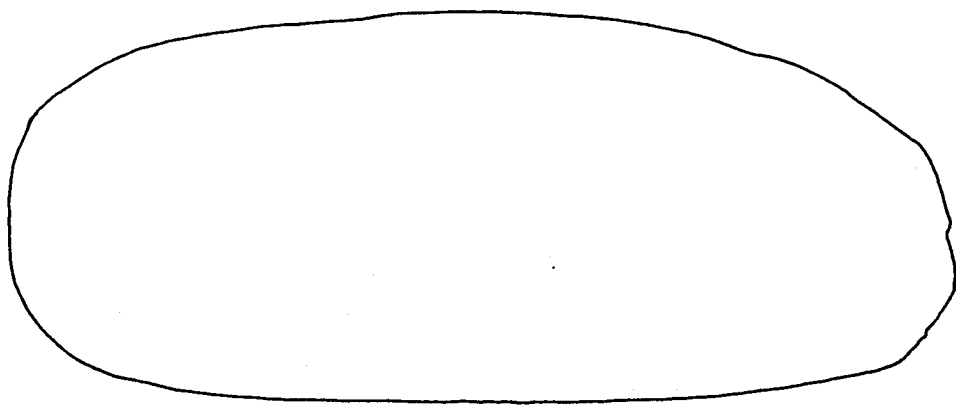
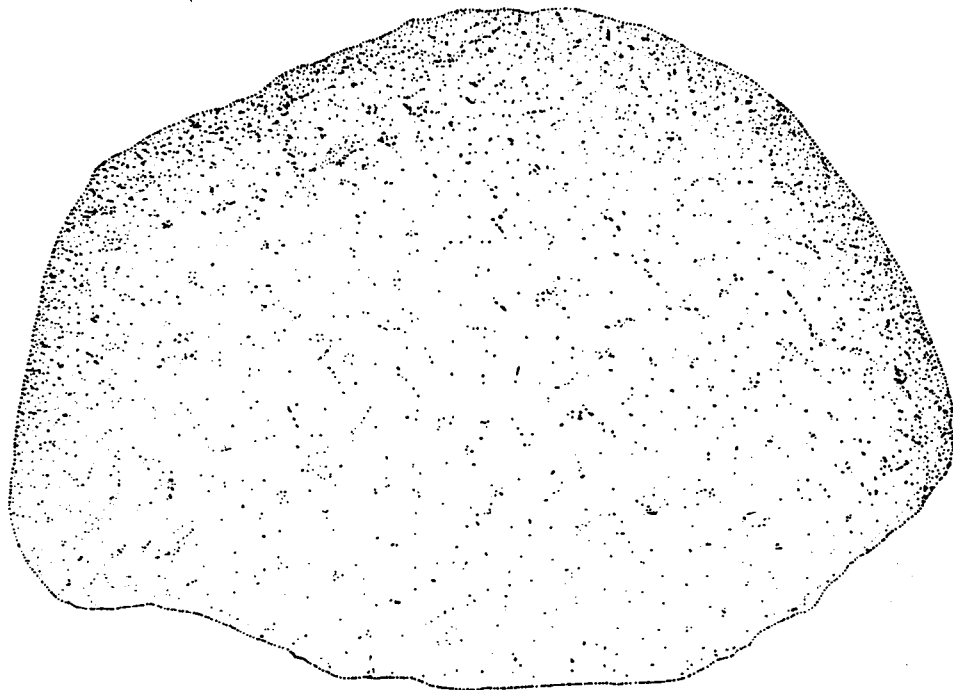

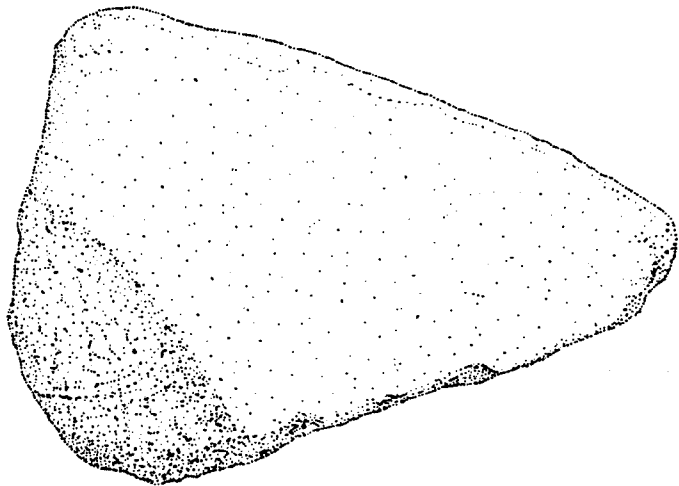
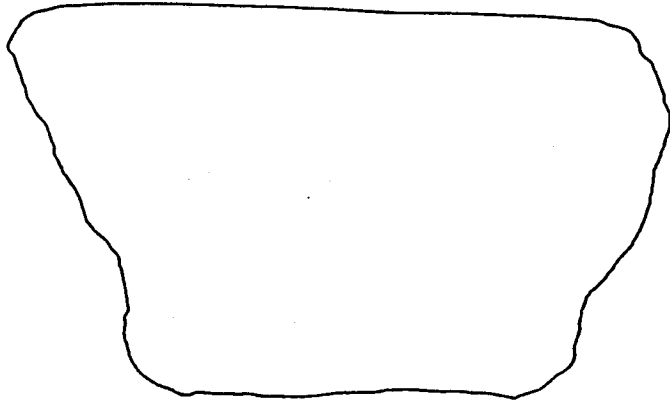
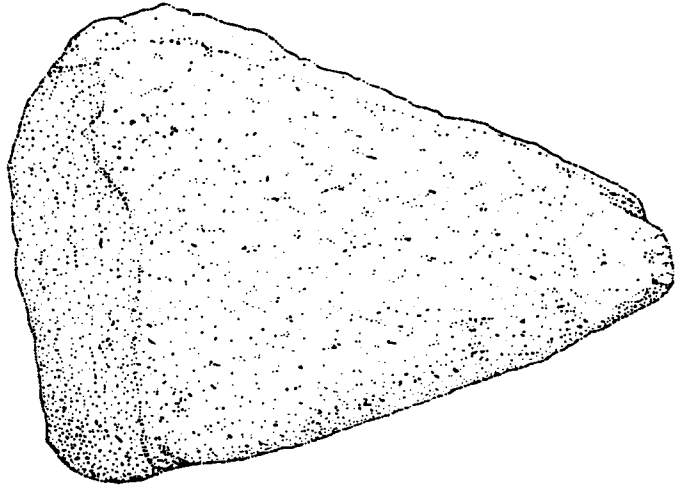

C 169

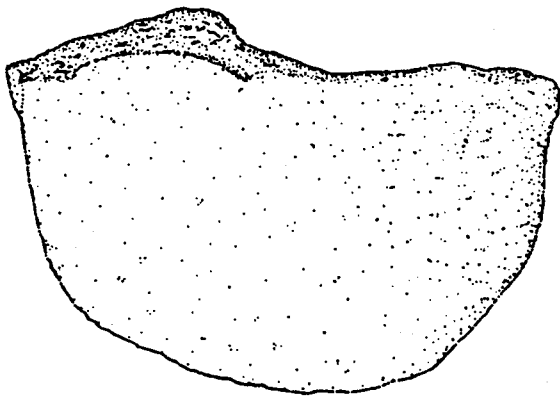
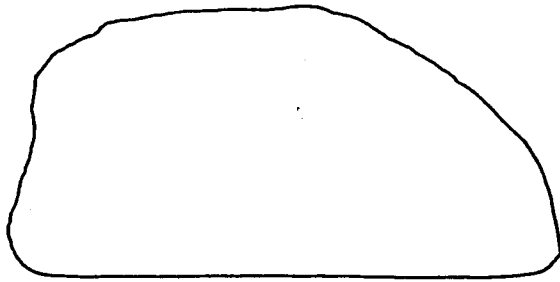
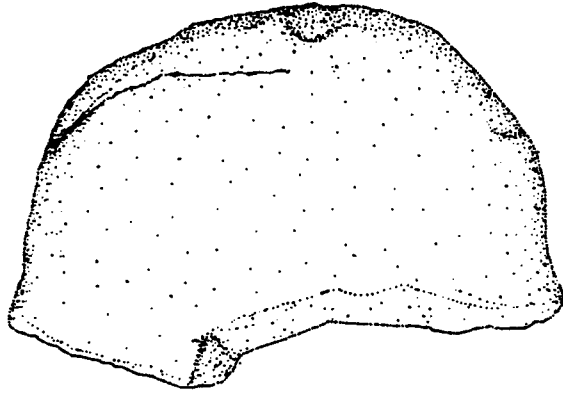

0  
5 cm

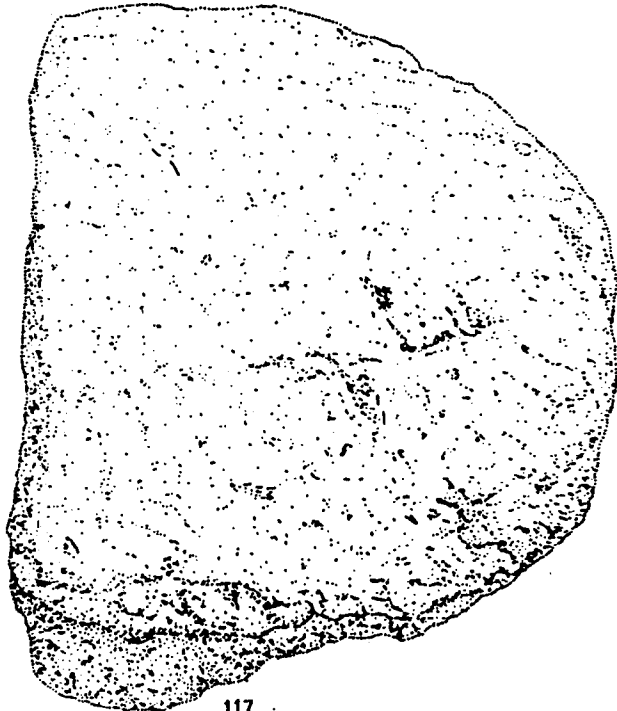
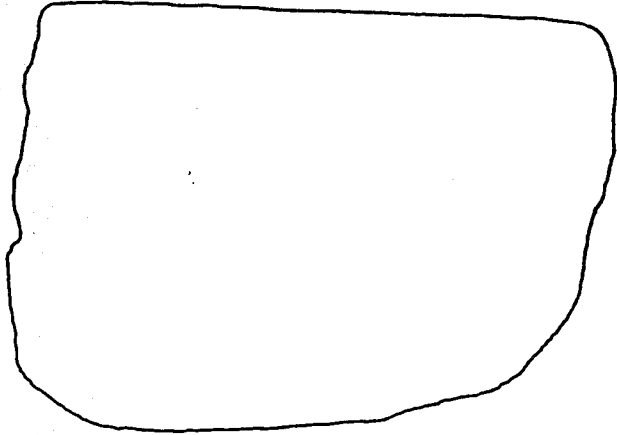
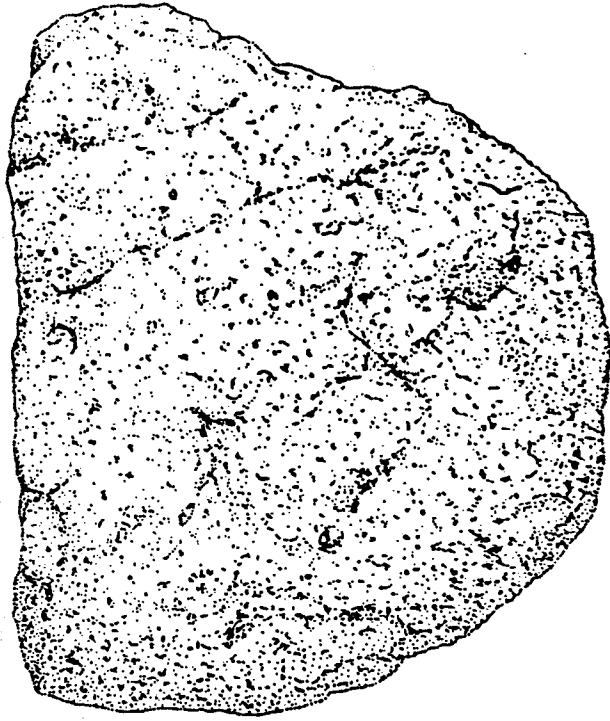

C 168

C 240

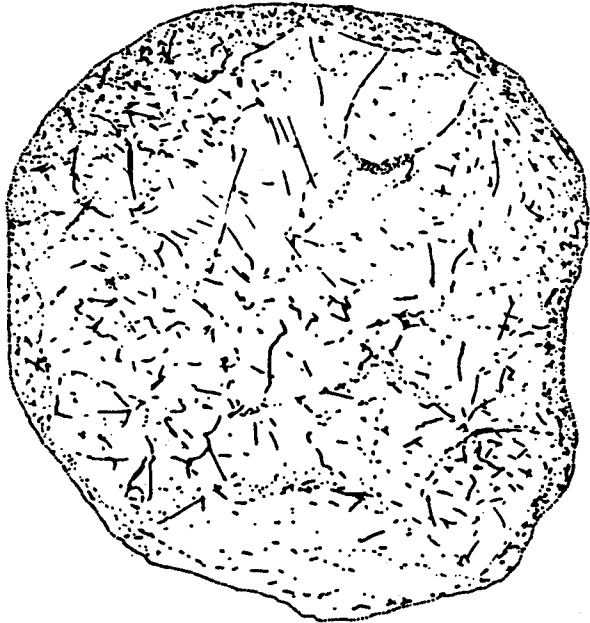
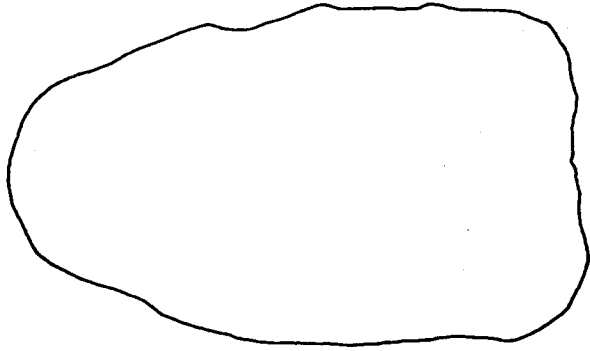
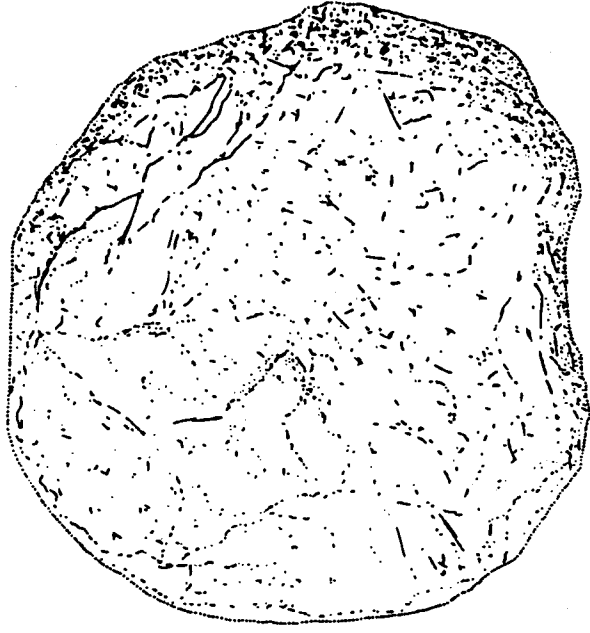



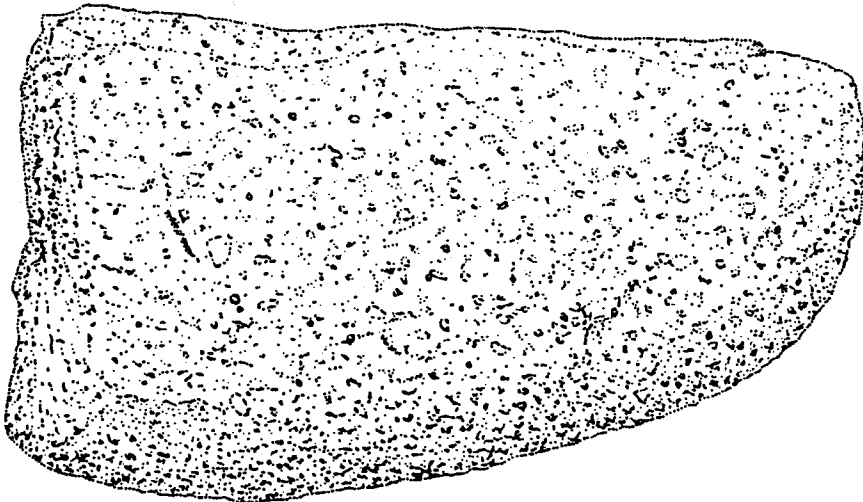
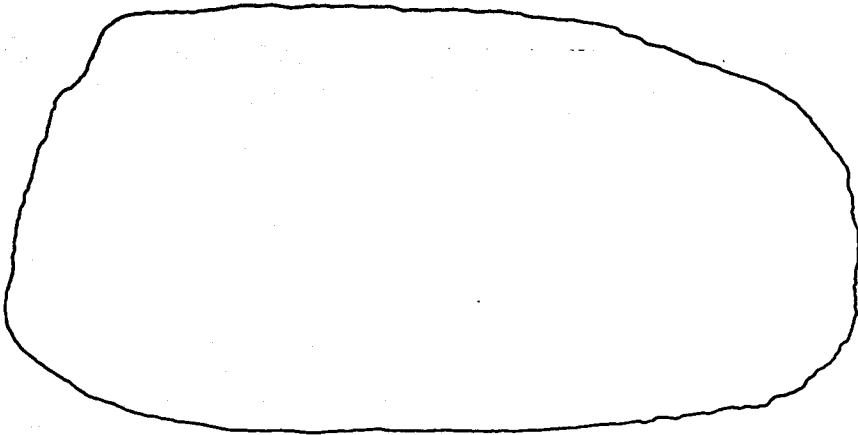
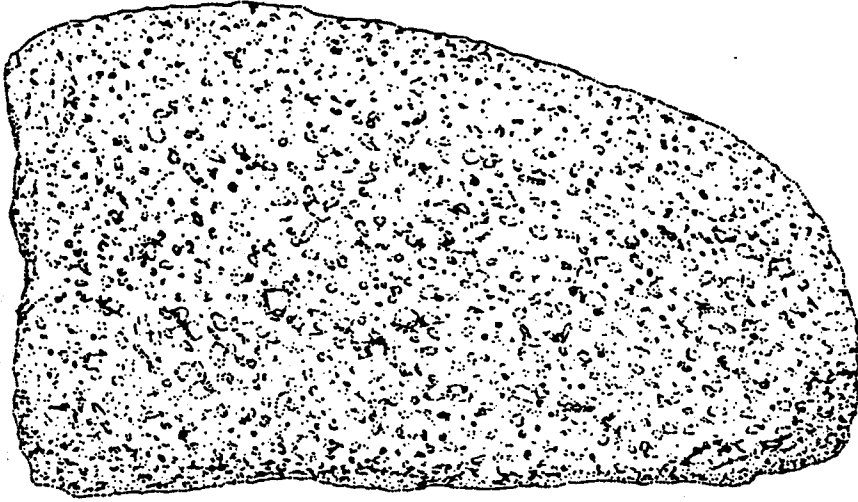

C 241

C 242

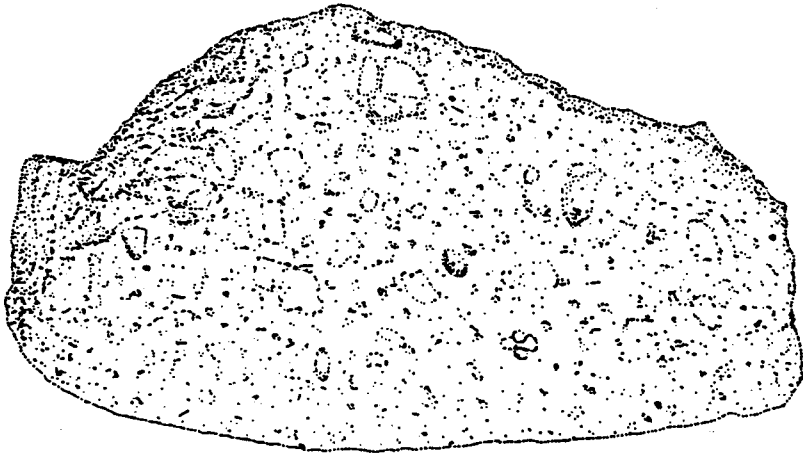
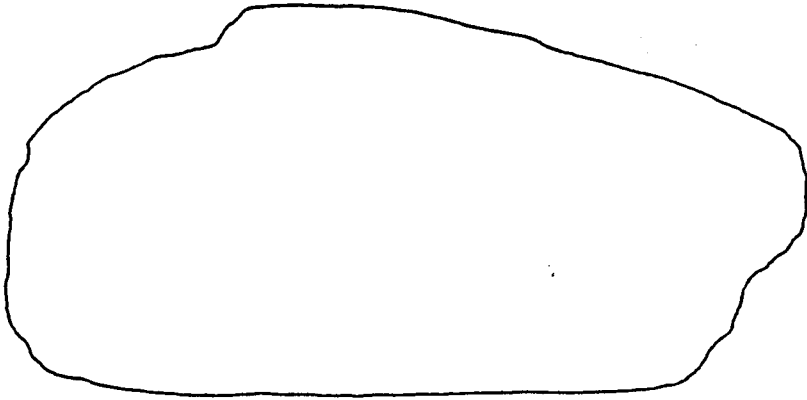
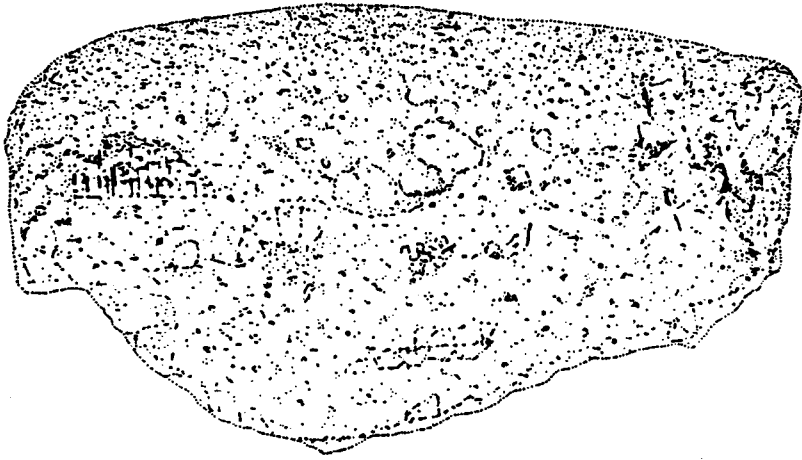

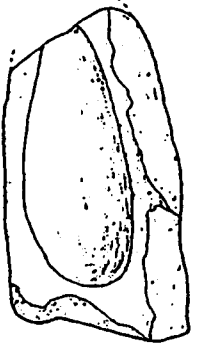
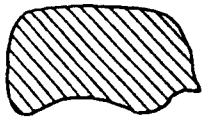

C244

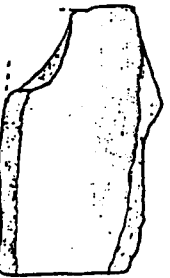

C245

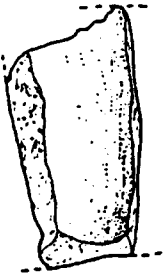

C246



C247

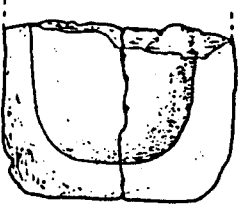

C248

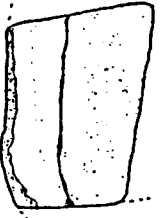
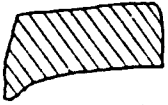

C249



C250

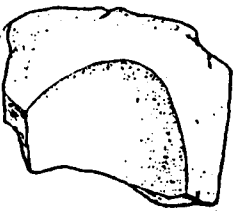
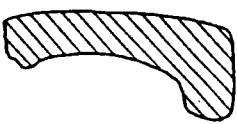

C251



C252

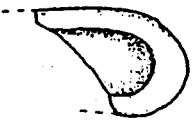

C253

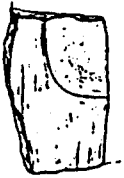

C254

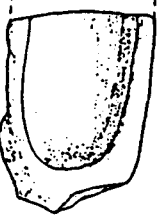

C255

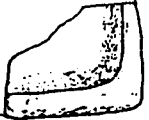
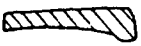

C256

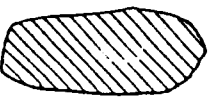

C257



C258



ANTA DA CABEÇUDA

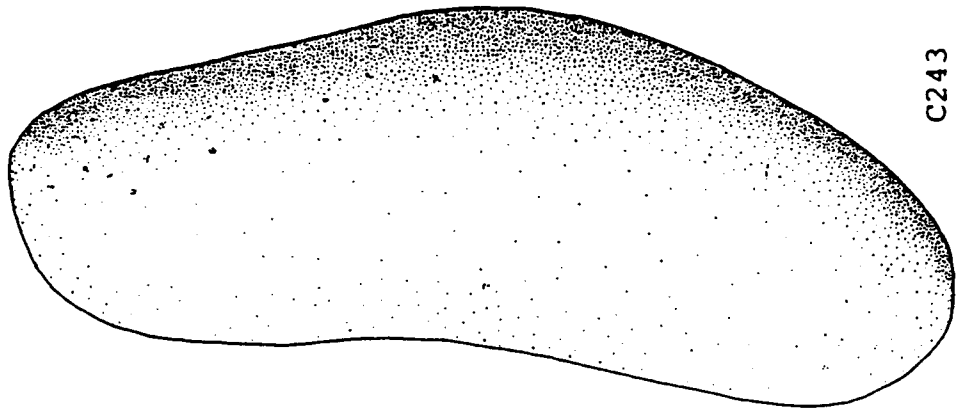

C243

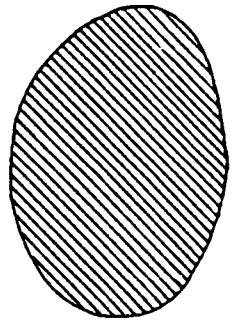
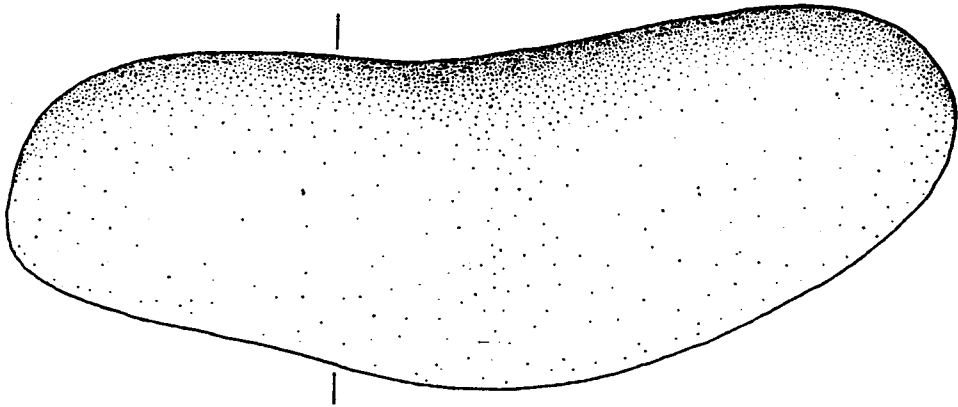
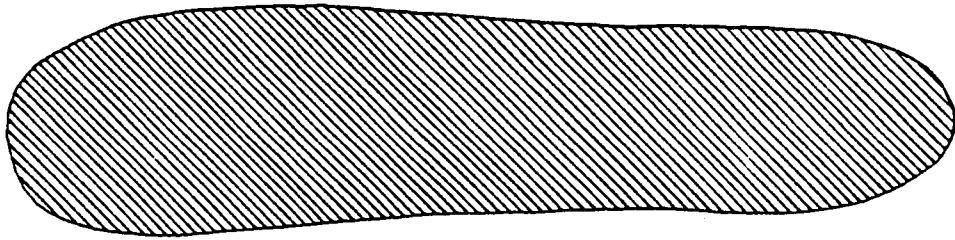



ANTA  
das  
**CASTELHANAS**



AC 94

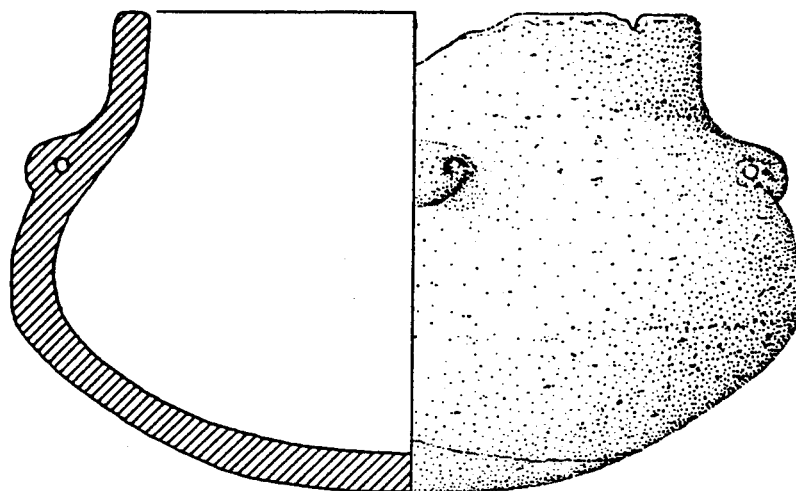

AC 86

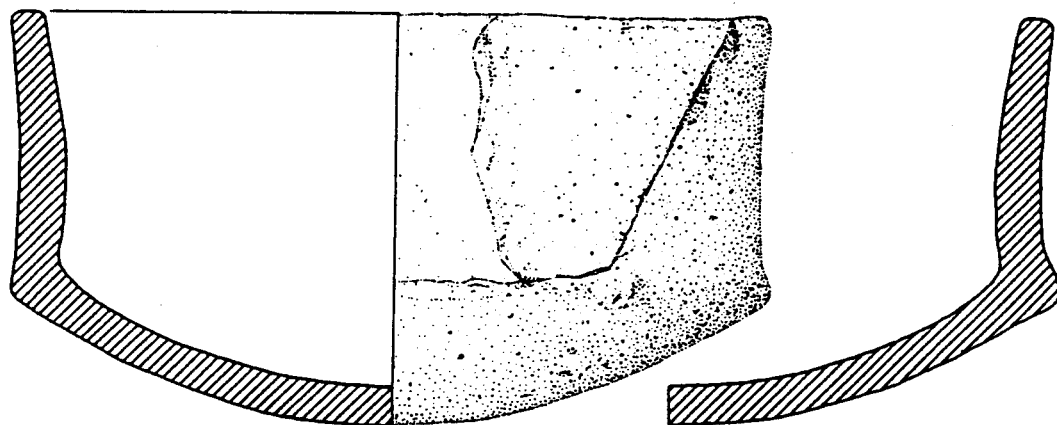

AC 87

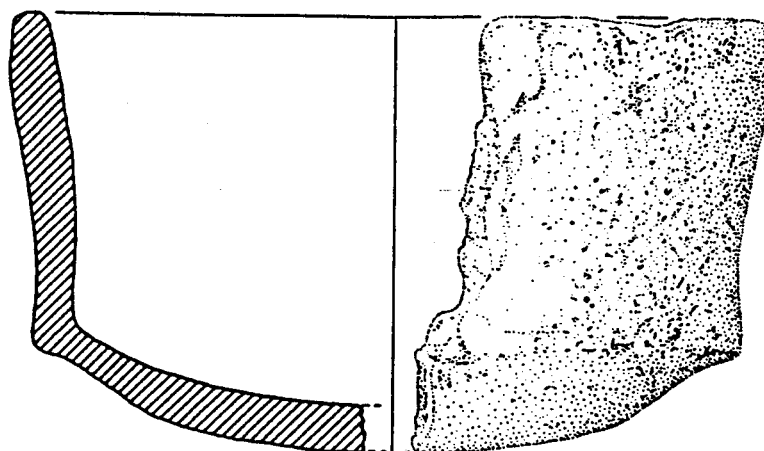



AC 84

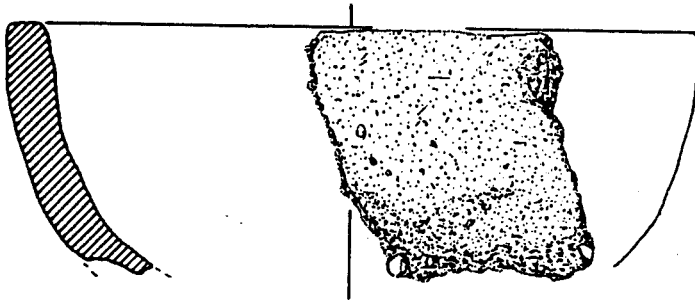

AC 82

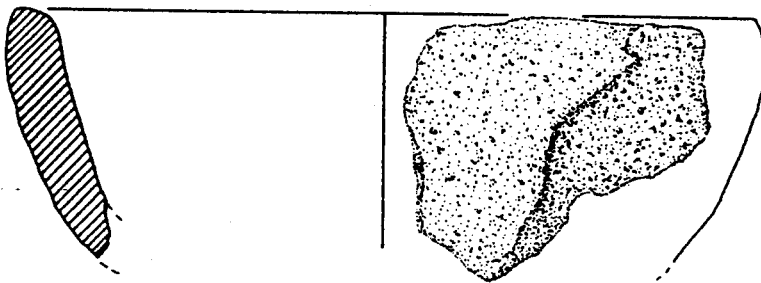

AC 89

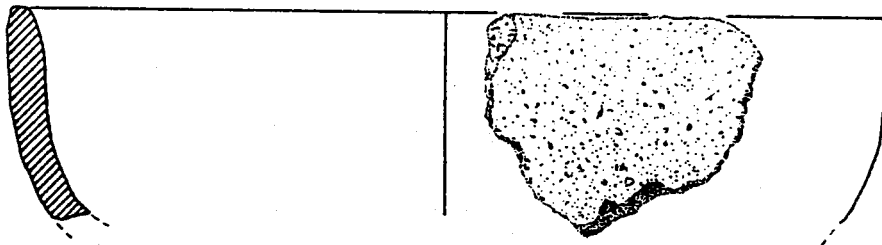

AC 74

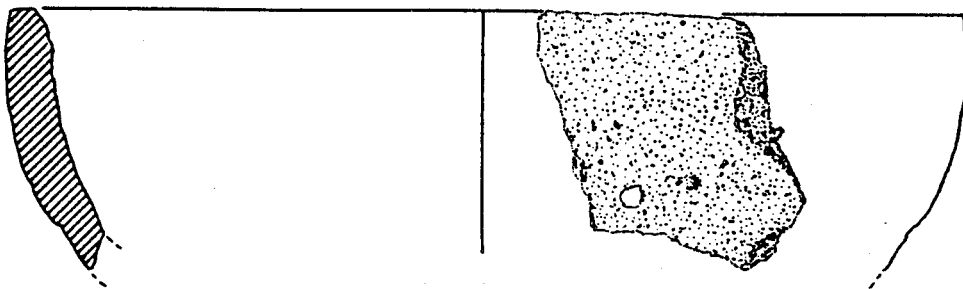

AC 68

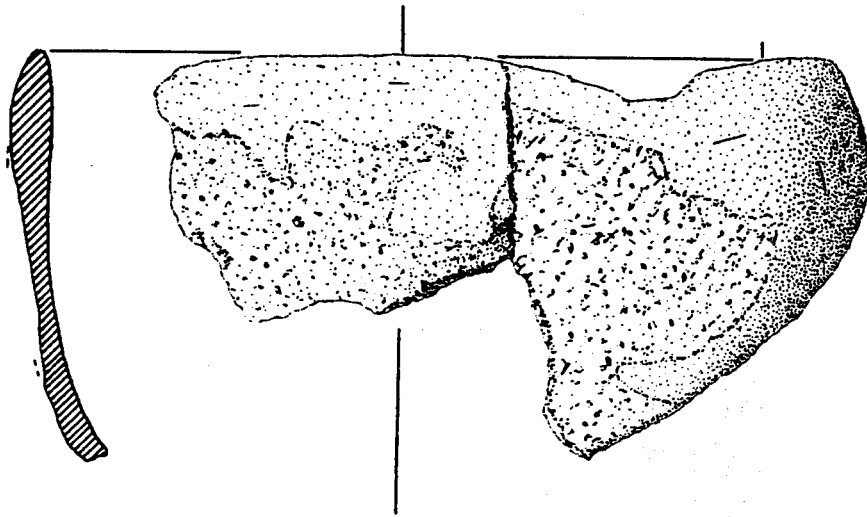

AC 93

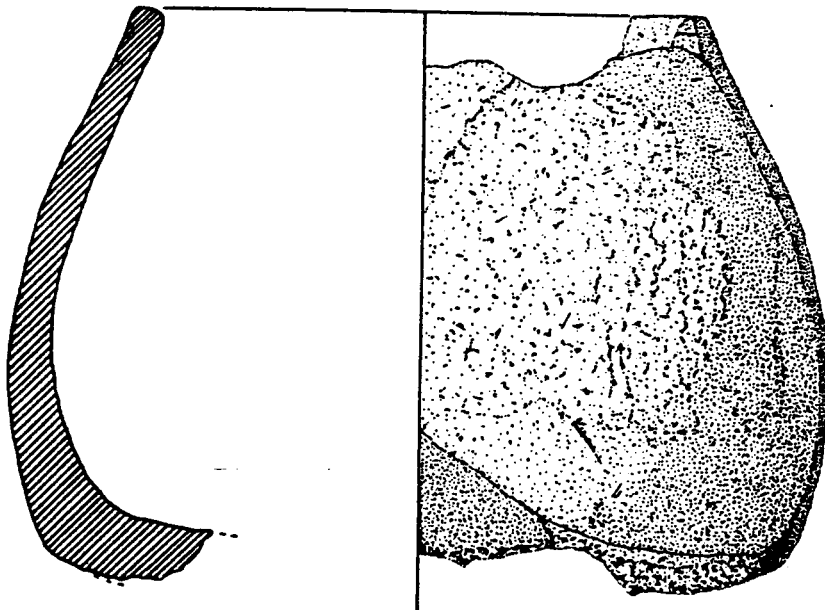

AC 78

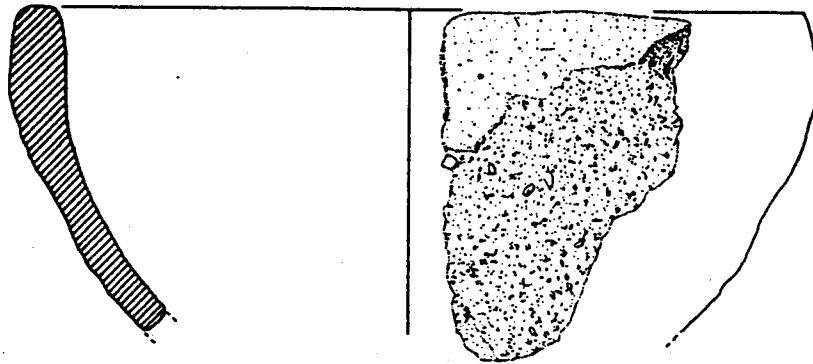

AC 66

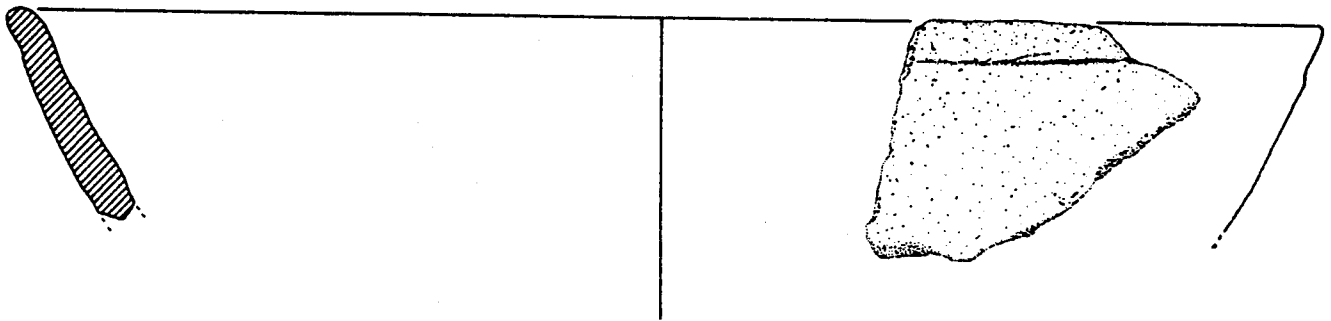

AC 69

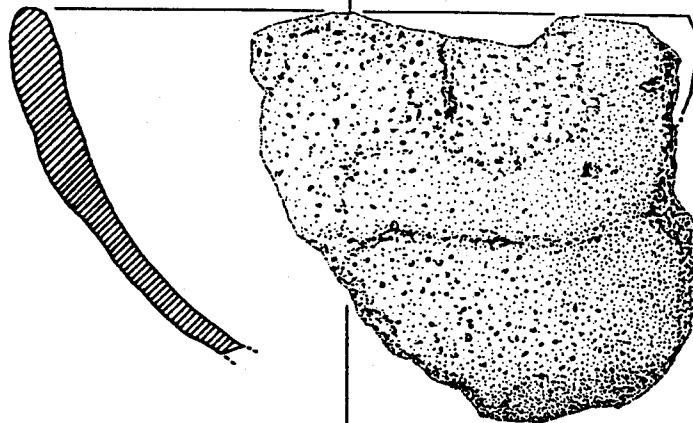

AC 63

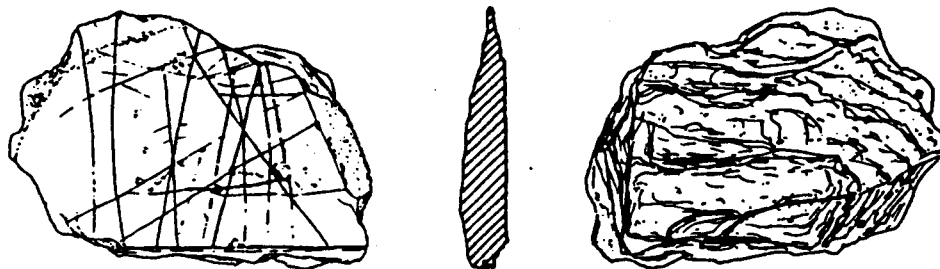

AC 76

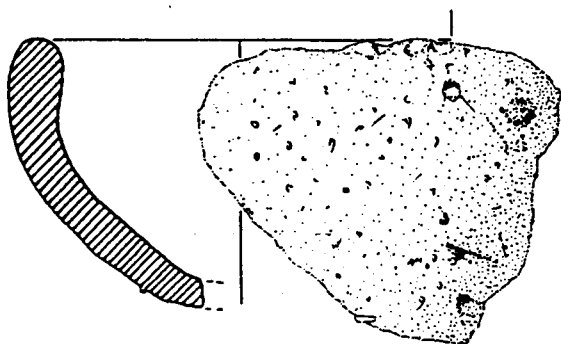

AC 67

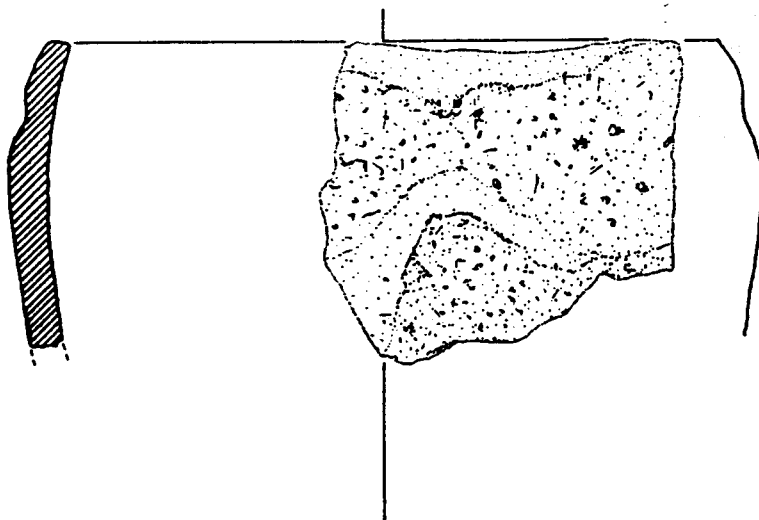

AC 73

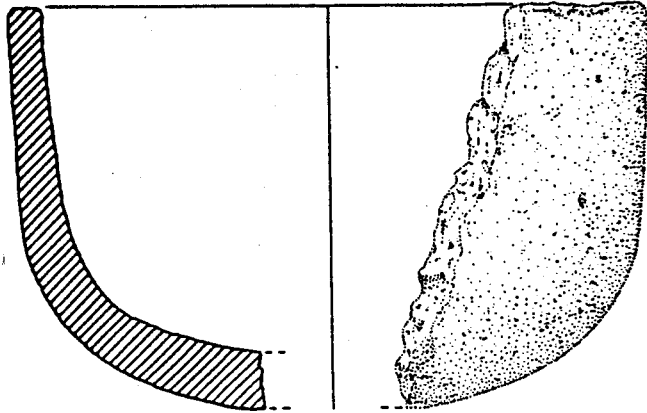

AC 90

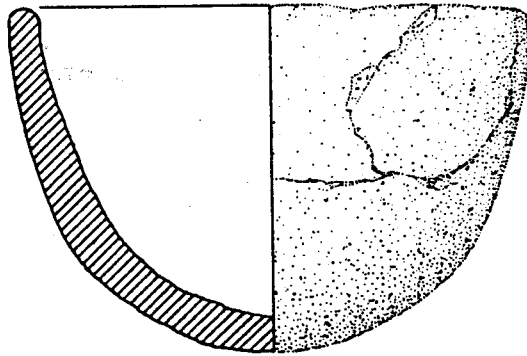

AC 79

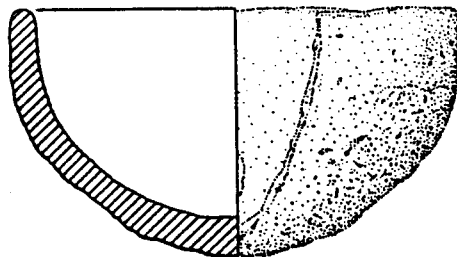

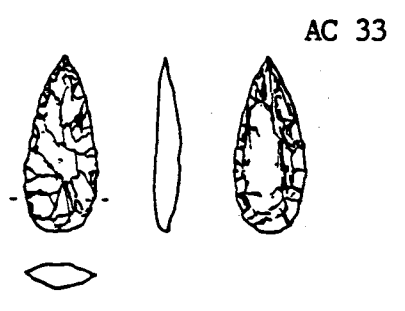
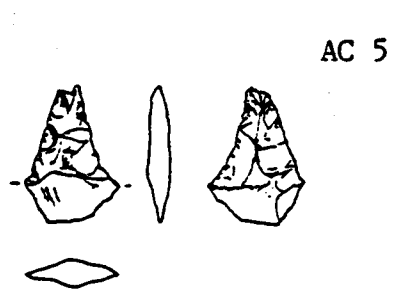
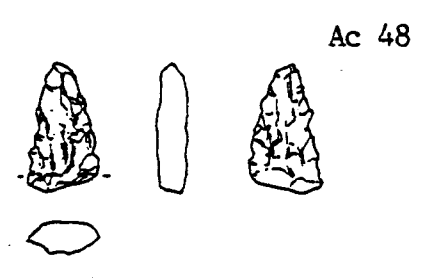
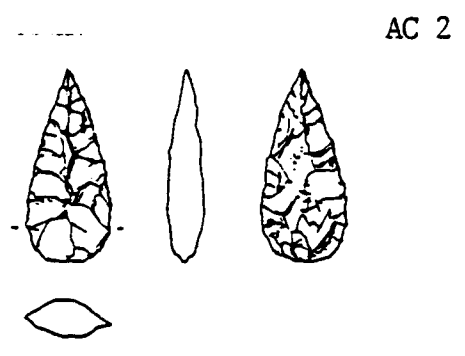
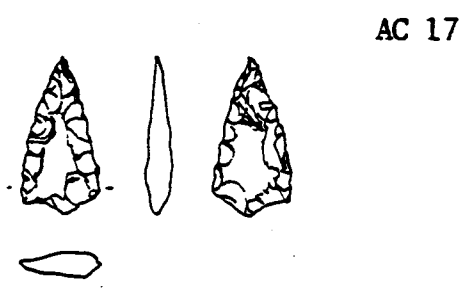
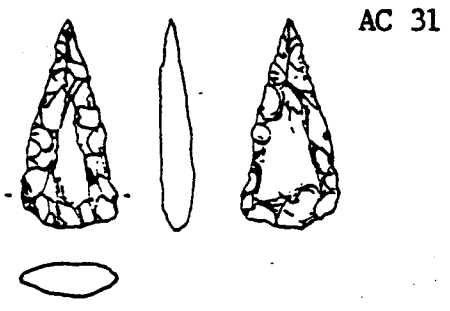

AC 16

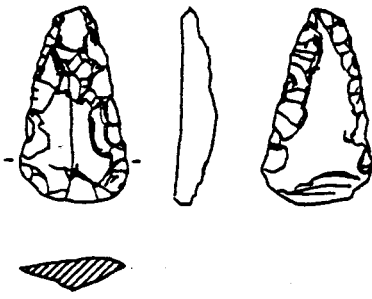

AC 37

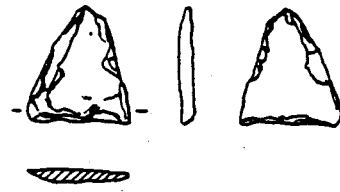

AC 52

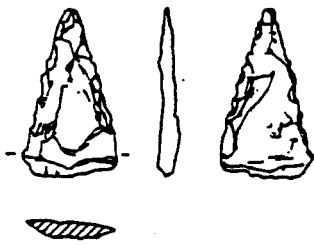

AC 14

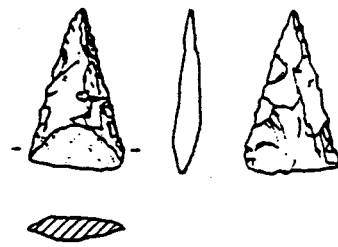

AC 9

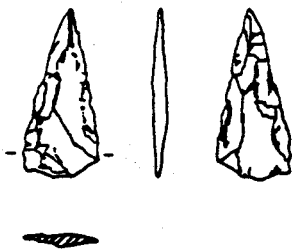

AC 3

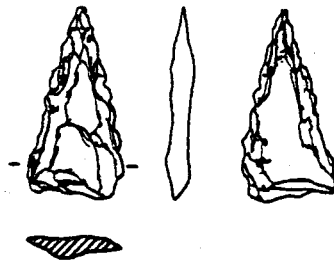

AC 20

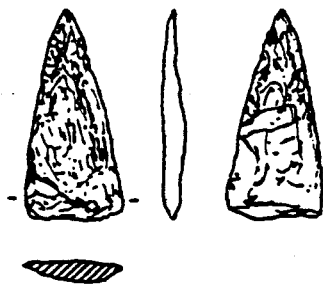

AC 42

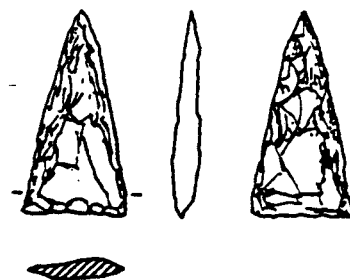

AC 18

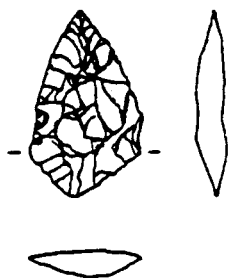

AC 47

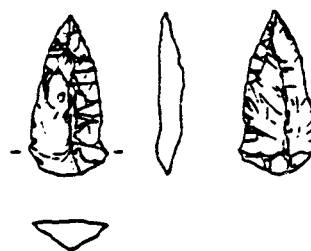

AC 12

AC 23

AC 10

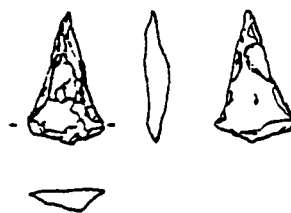
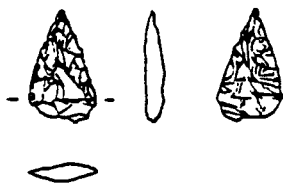
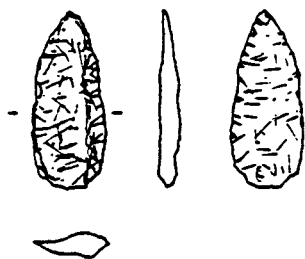

AC 51

AC 41

AC 29

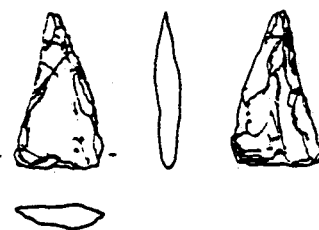
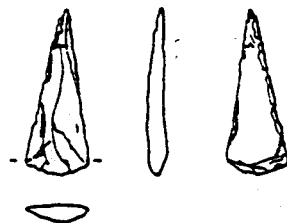
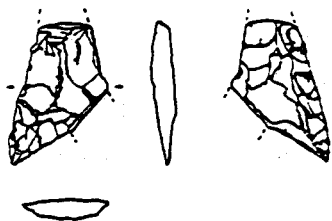

AC 21

AC 26

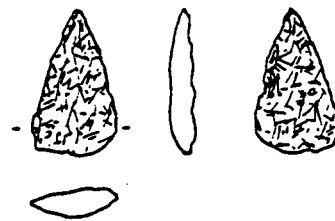
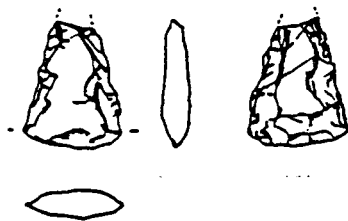





AC 43



AC 44

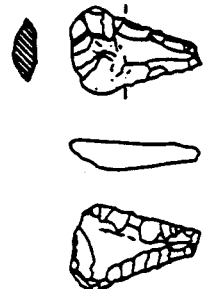

AC 45

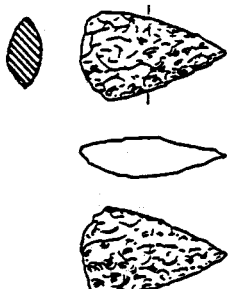

AC 46

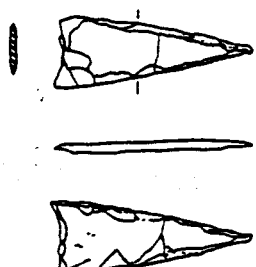

AC 49

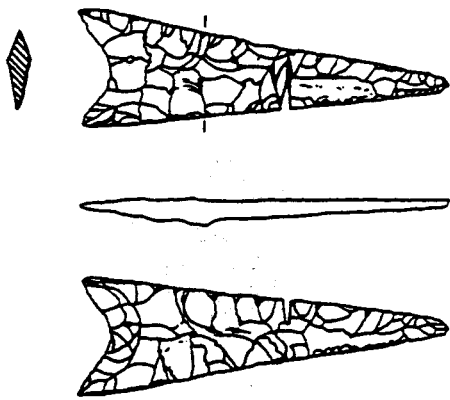

AC 53

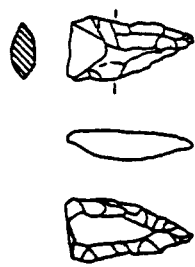

AC 54

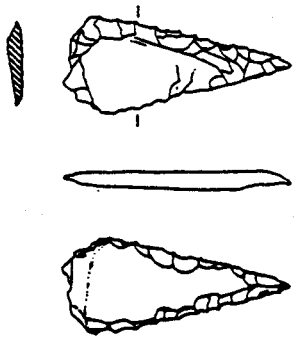

AC 55



AC 4

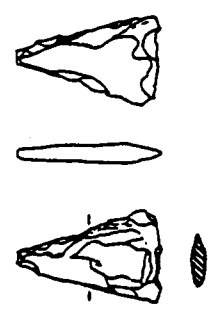

AC 8

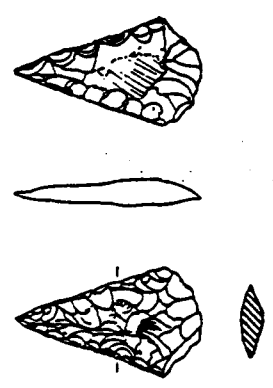

AC 11

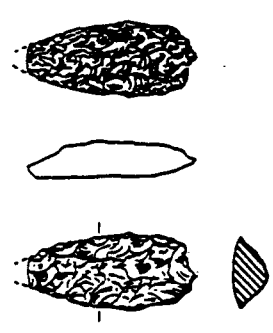

AC 6

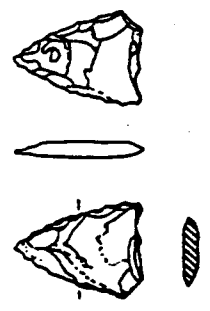

AC 13

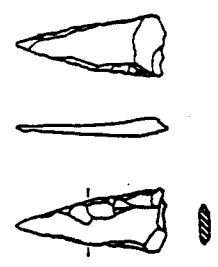

AC 22

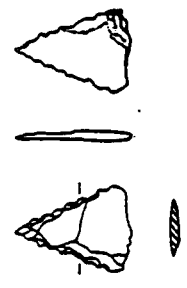

AC 7

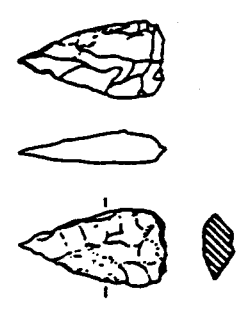

AC 15

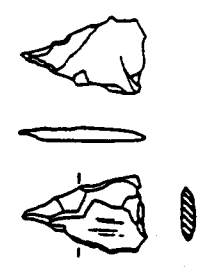

AC 17

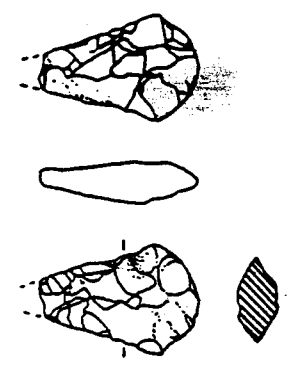

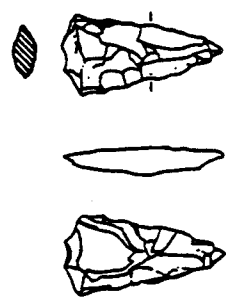

AC 25

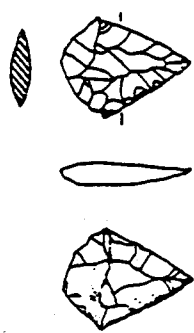

AC 32

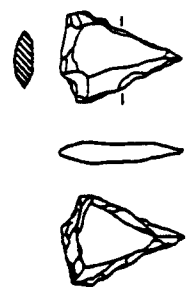

AC 36

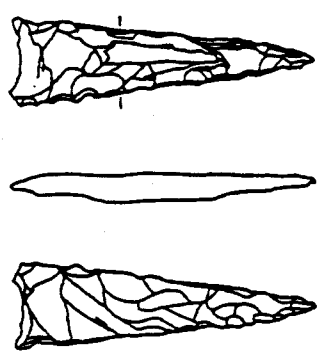

AC 27

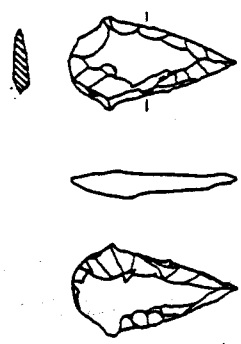

AC 34

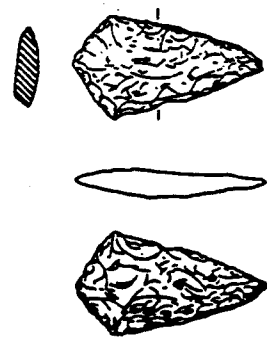

AC 39

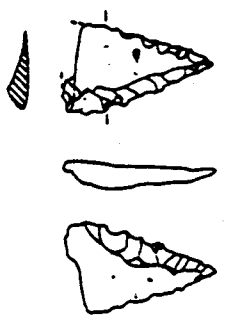

AC 28

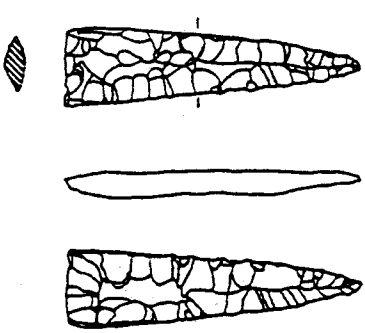

AC 35

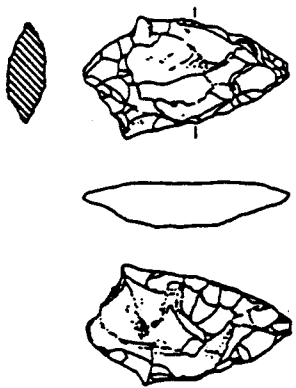

AC 40



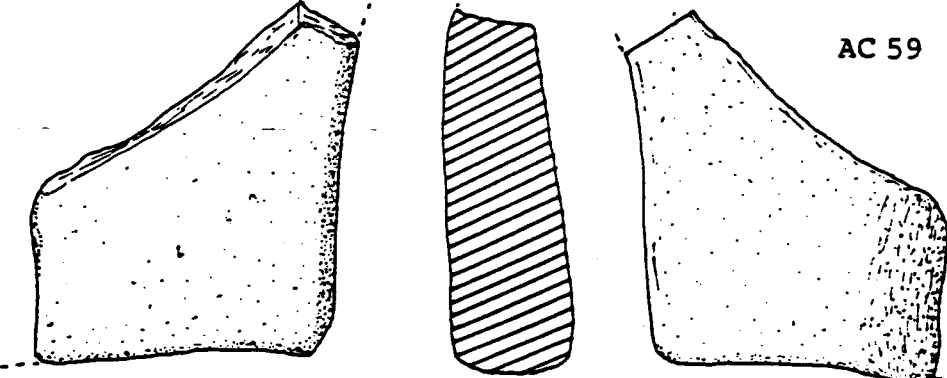
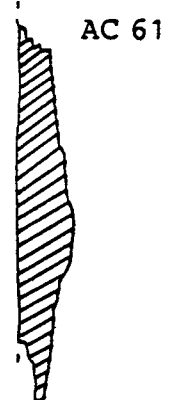
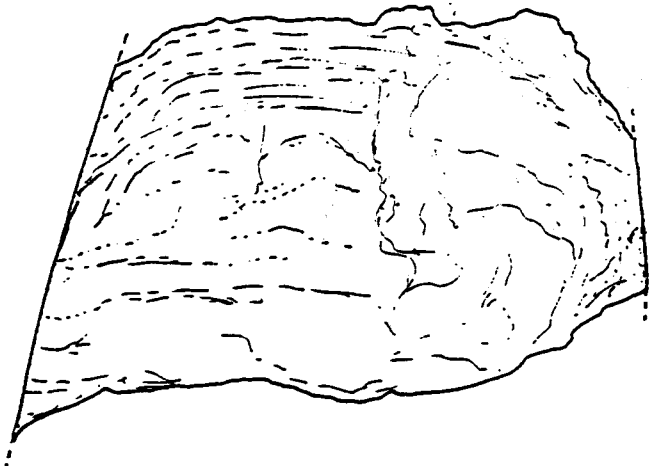
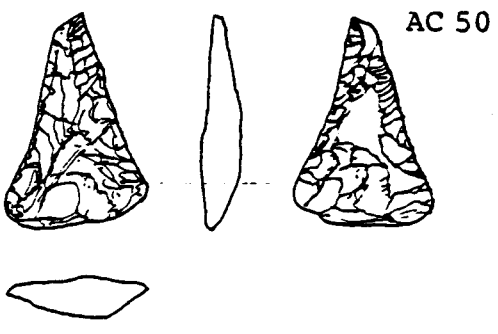
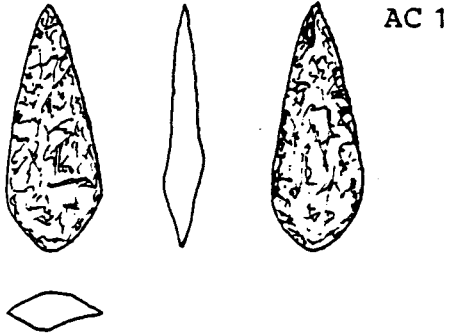
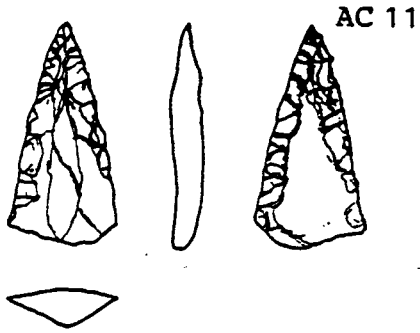
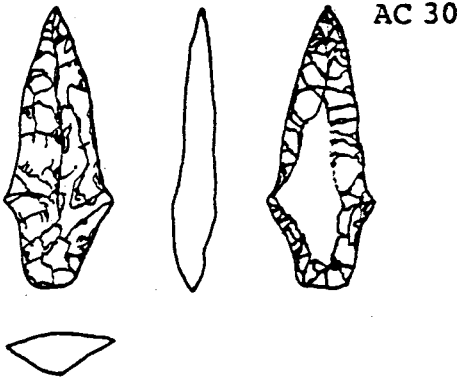

AC 60

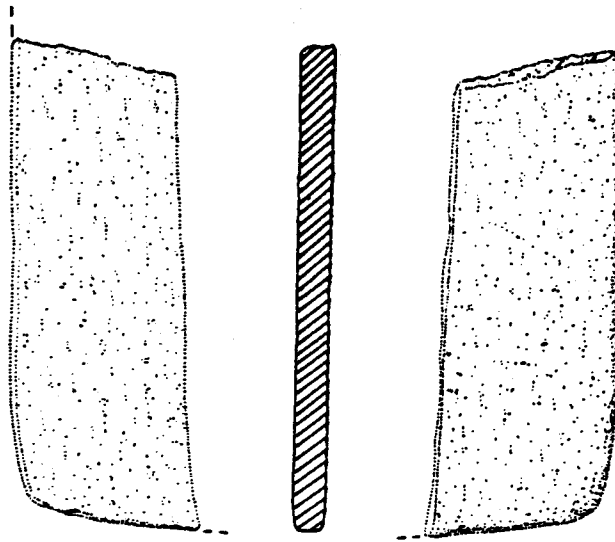

AC 56

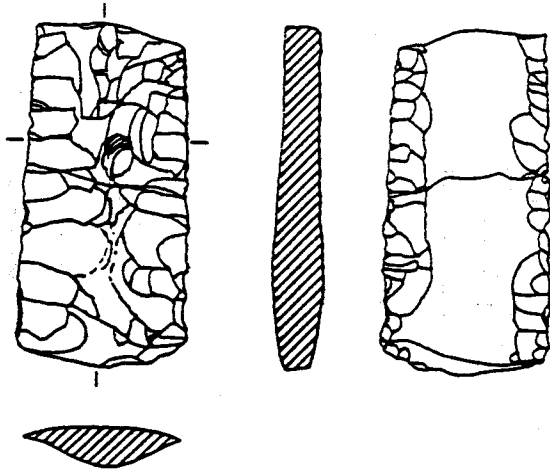

AC 64

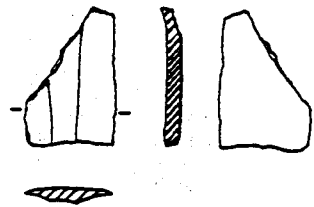

AC 58

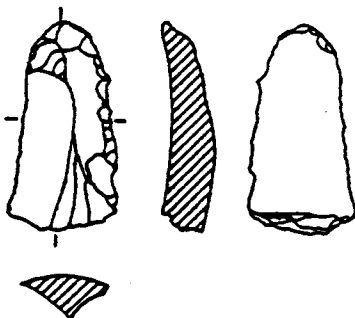

AC 38

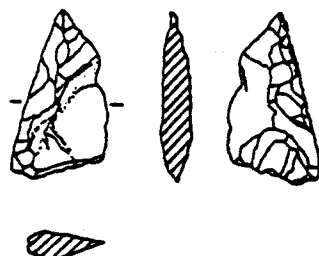

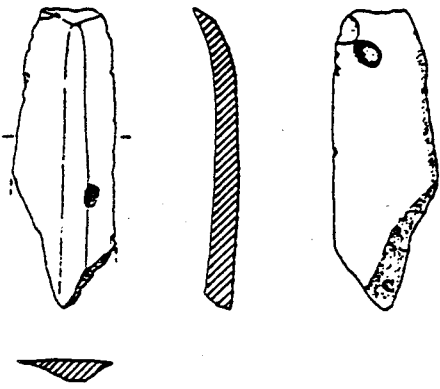

AC 57

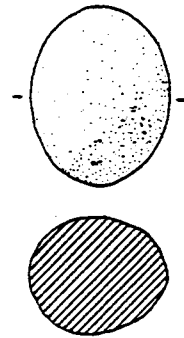

AC 65

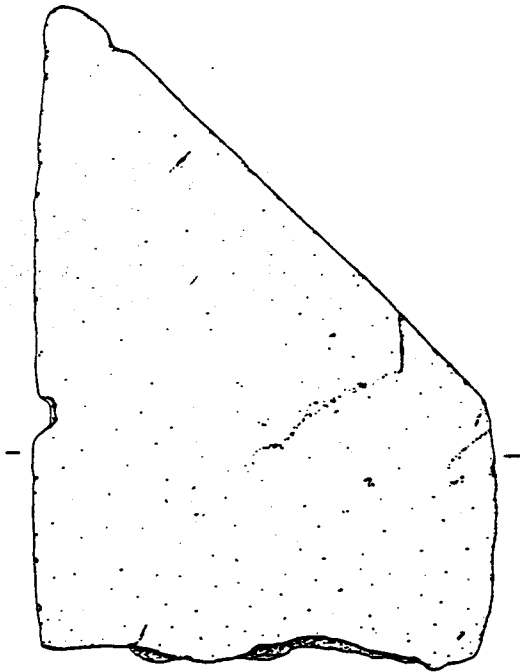

AC 62

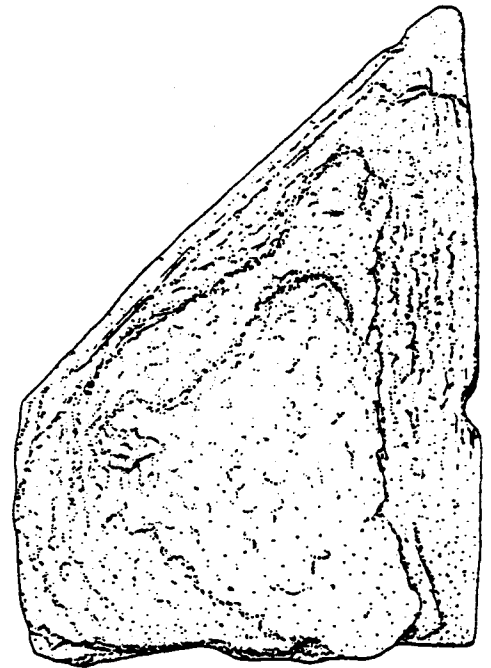

h

AC 98

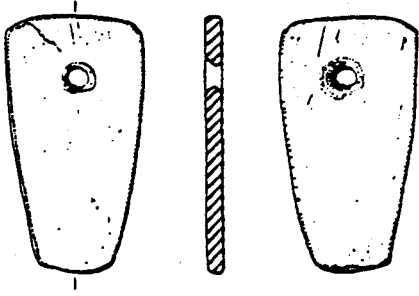

AC 96

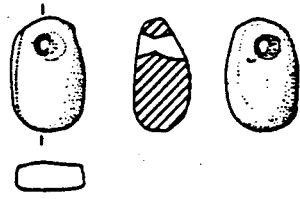

AC 100

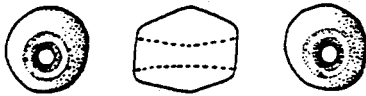

AC 104



AC 101

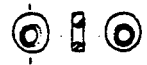

AC 97

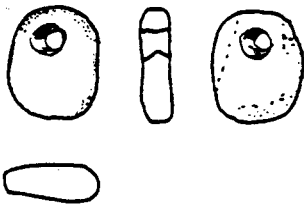

AC 99

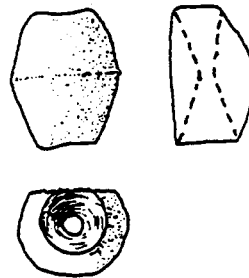

AC 102



AC 103



ANTA  
da  
**FIGUEIRA BRANCA**





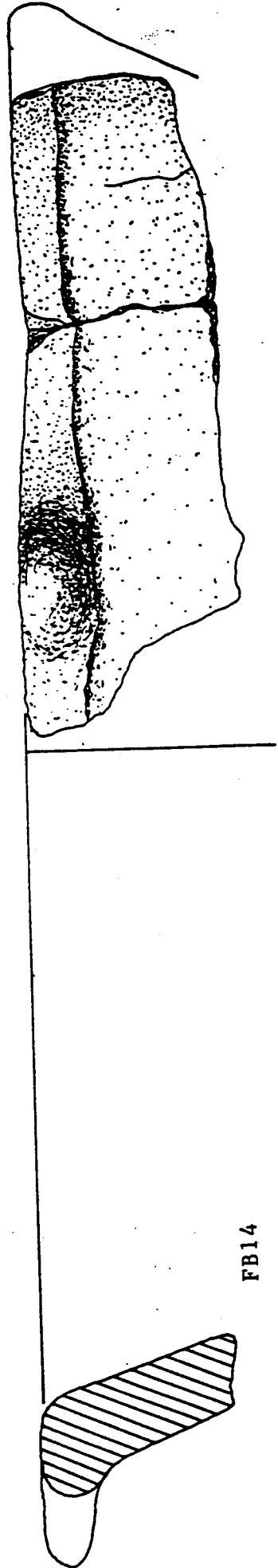
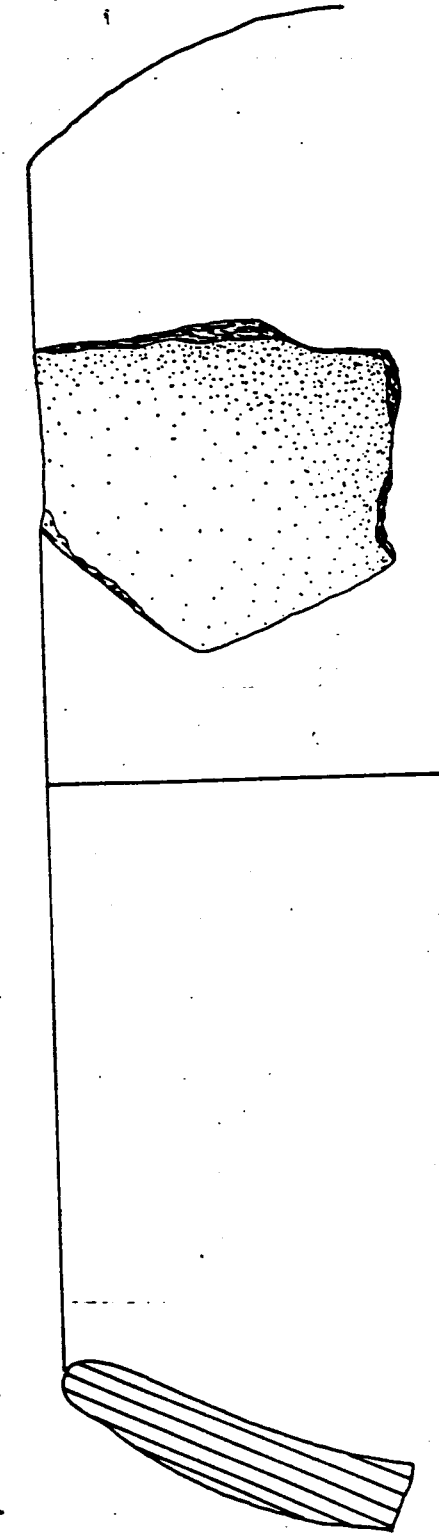
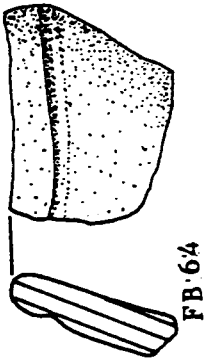
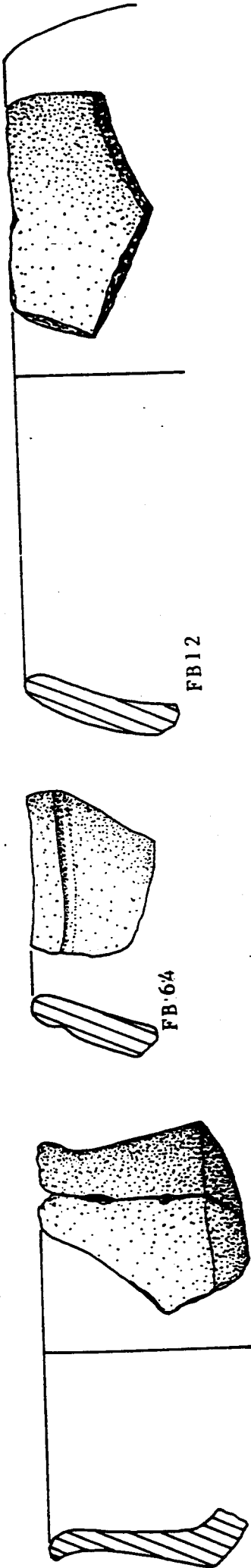

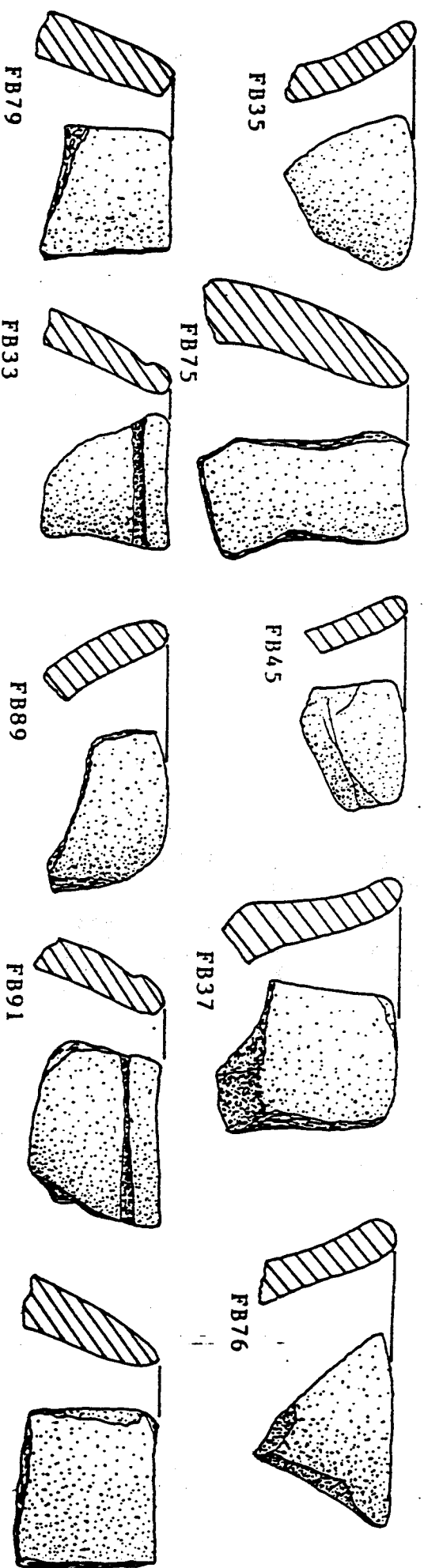
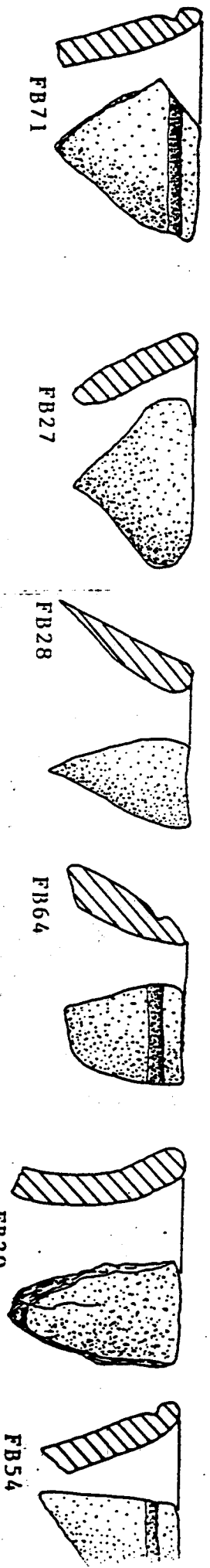
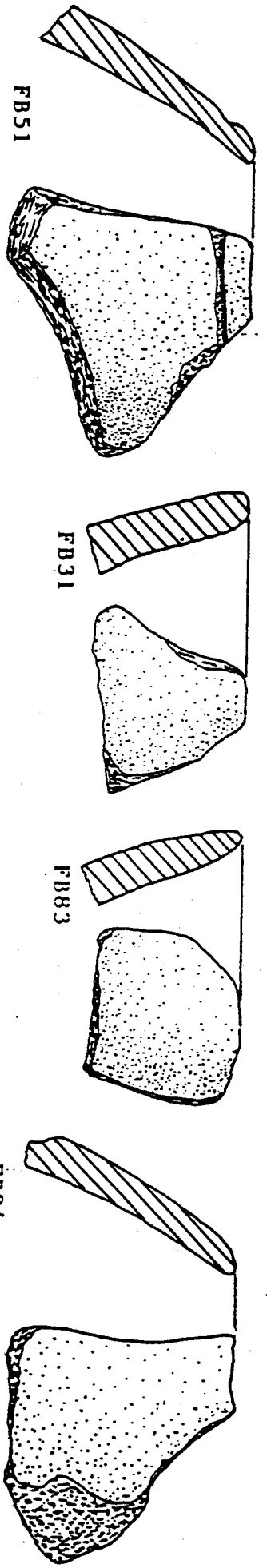

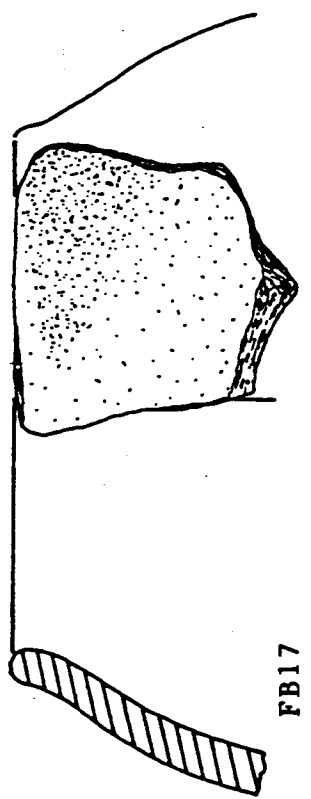
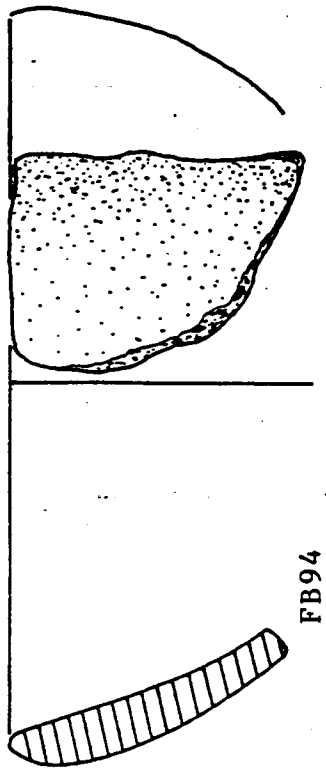
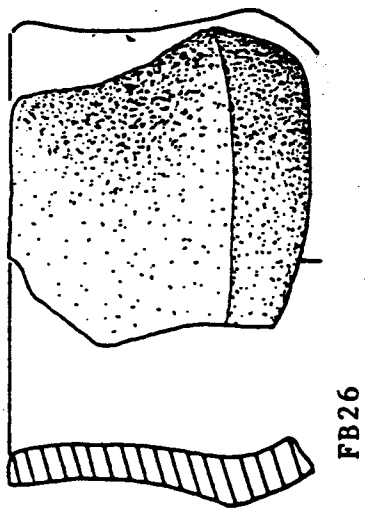
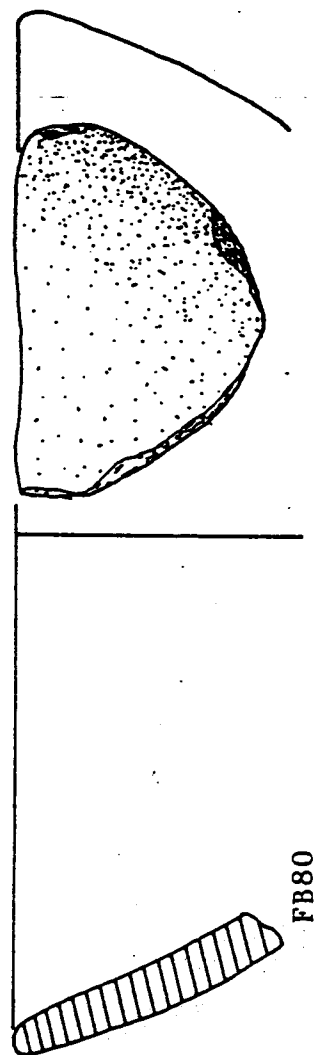
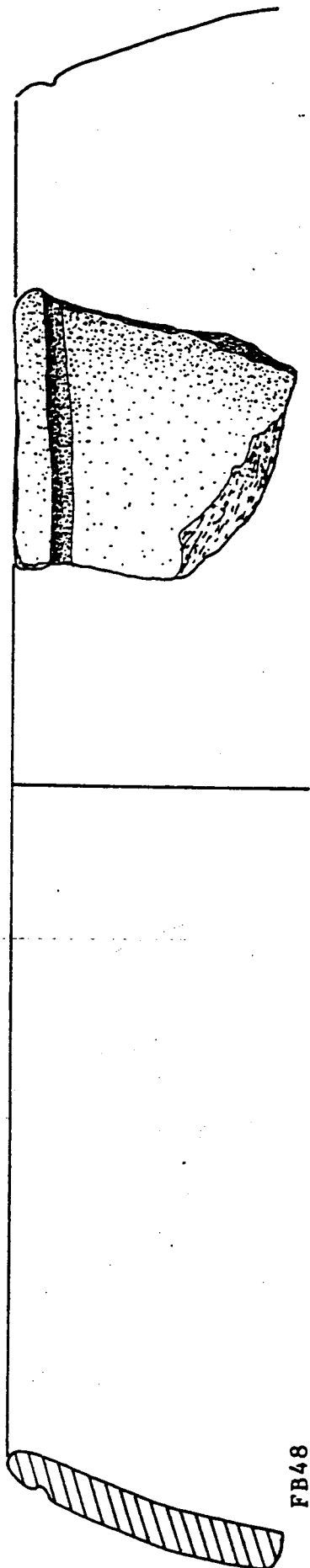

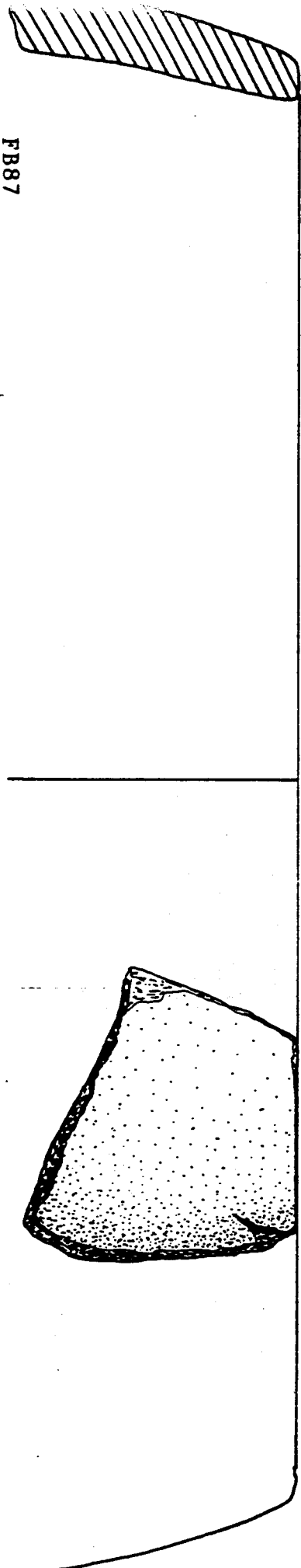

FB87

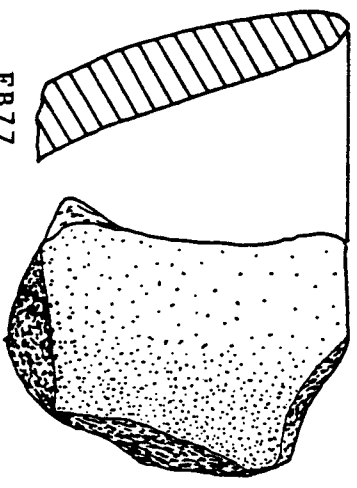

FB77

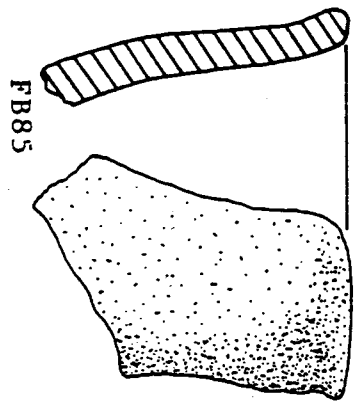

FB85

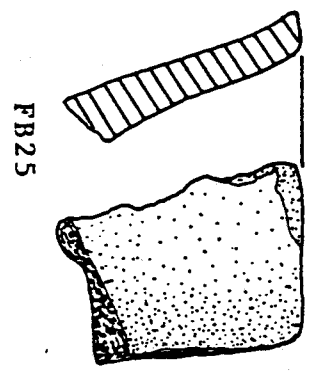

FB25

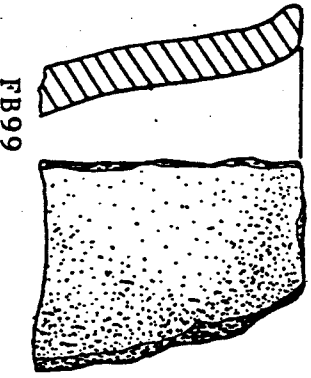

FB99

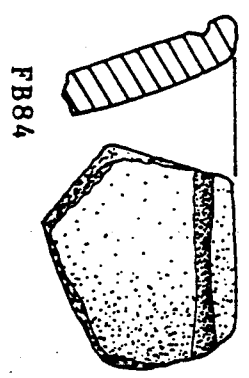

FB84

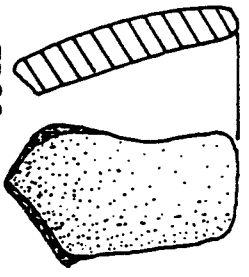

FB82

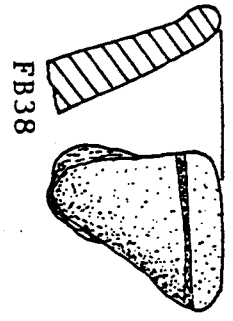

FB38

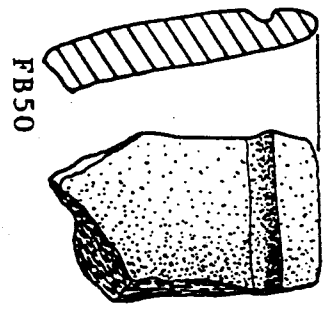

FB50

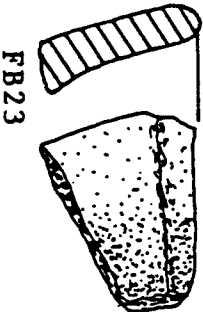

FB23



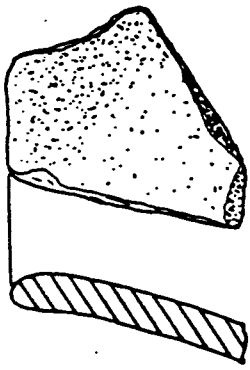

FB20

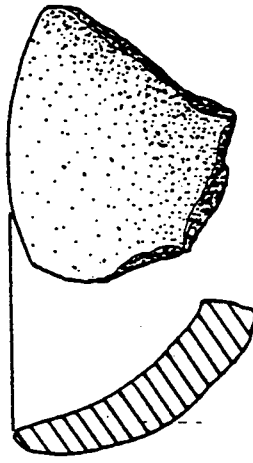

FB40

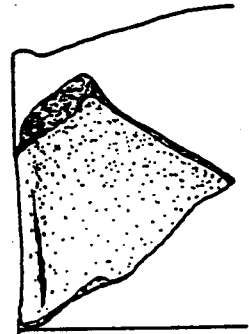

FB11

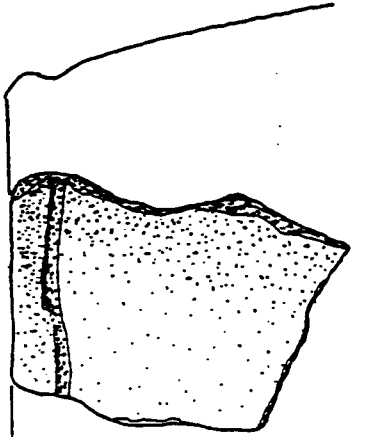

FB65

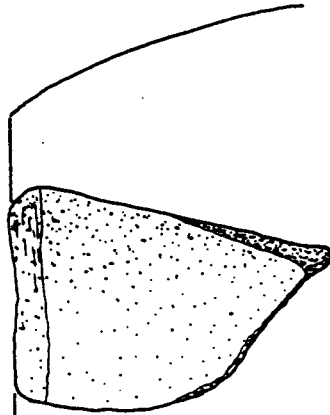

FB90

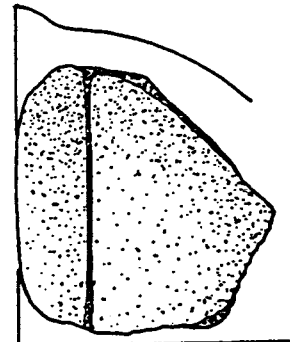

FB18

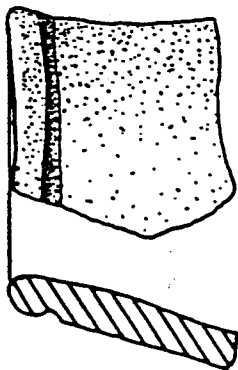

FB24

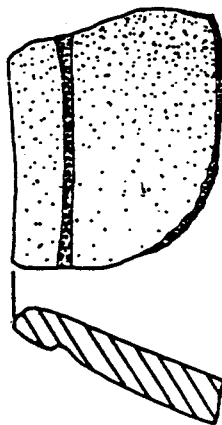

FB81

FB78

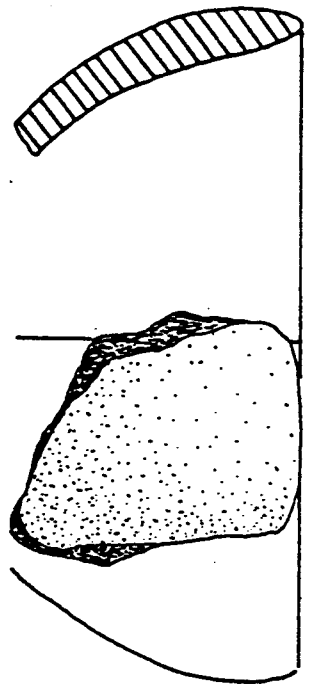

FB16

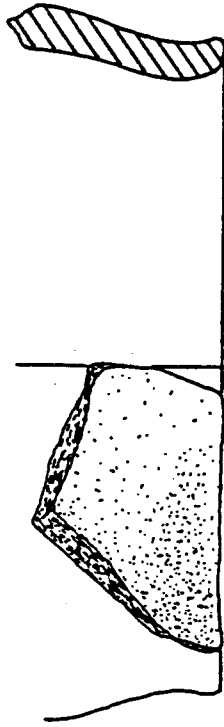

FB10

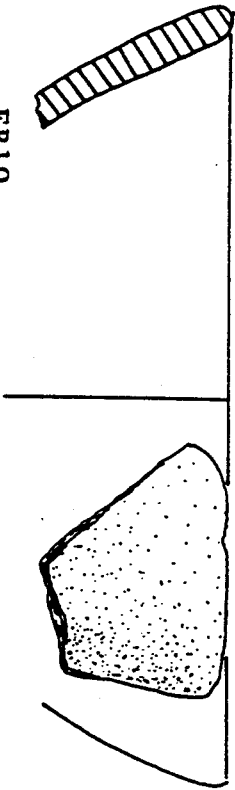

FB19

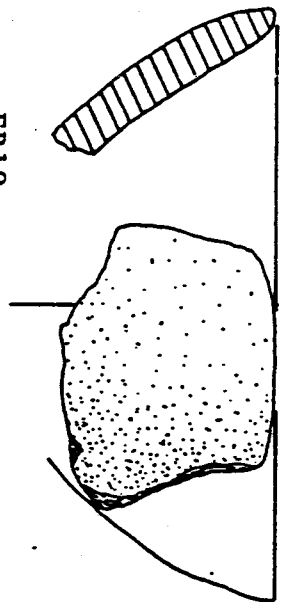

FB86

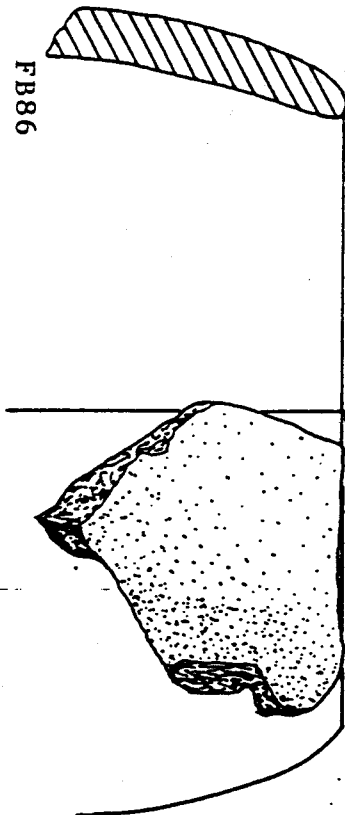

FB32

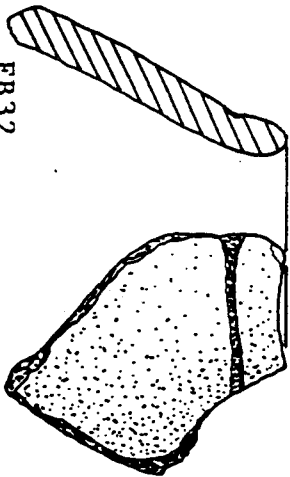

FB88

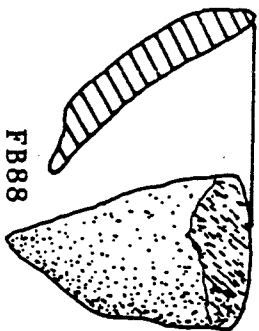

FB2

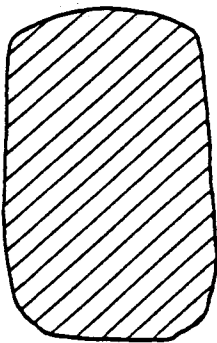
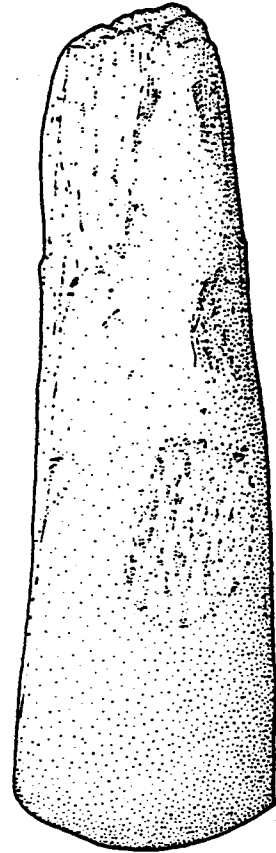
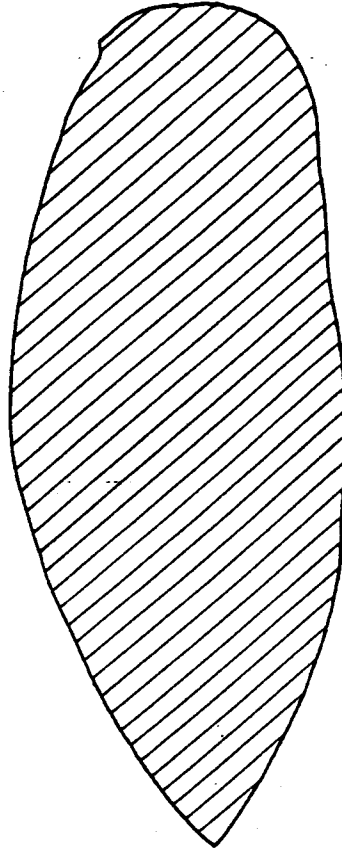
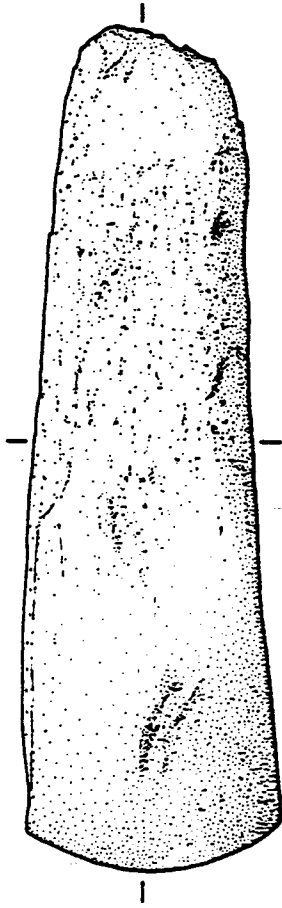



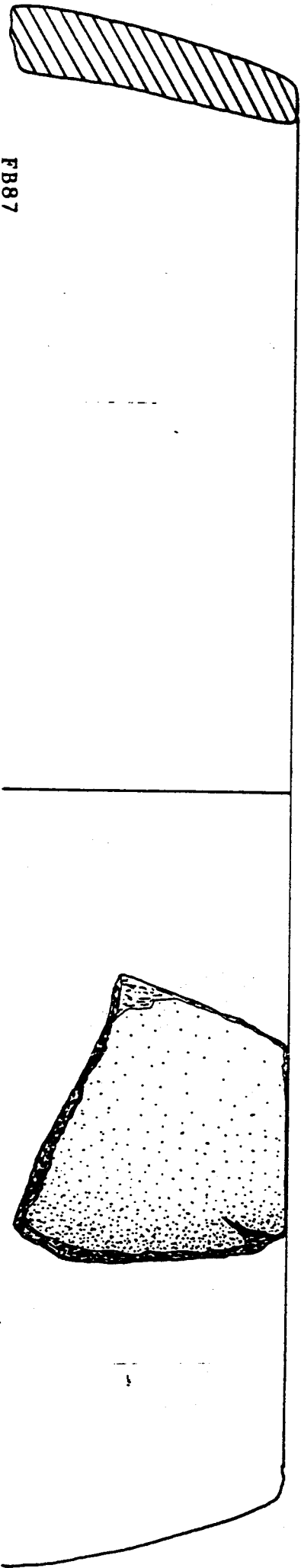

FB87

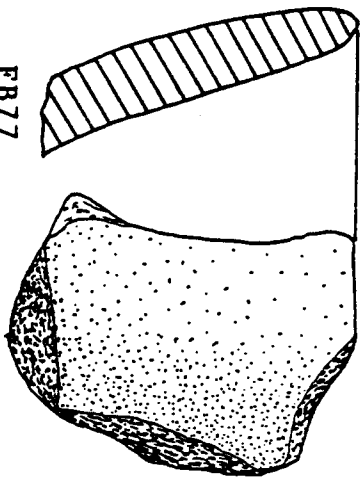

FB77

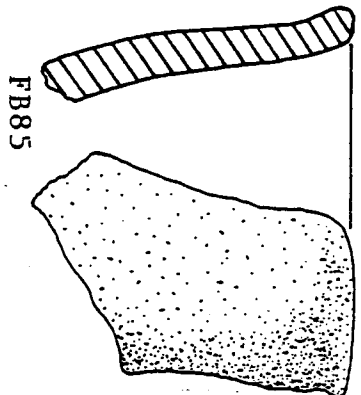

FB85

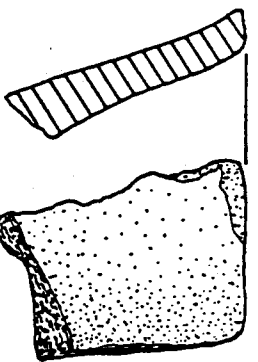

FB25

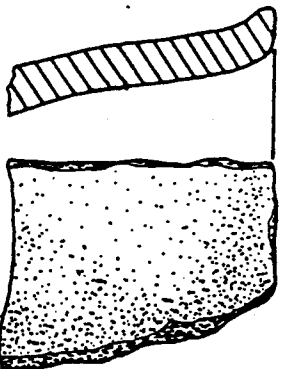

FB99

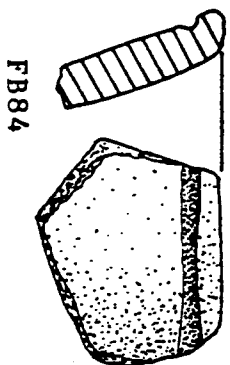

FB84

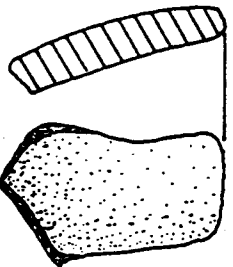

FB82

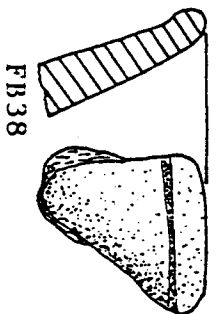

FB38

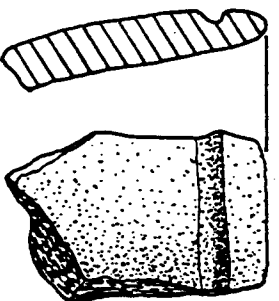

FB50

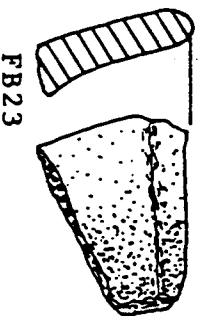

FB23



FB 4

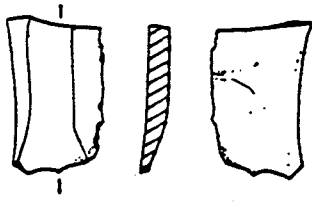

FB 7

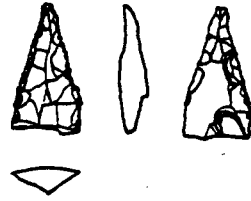

FB 8

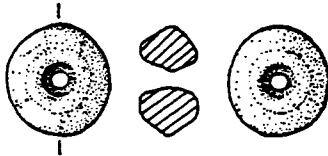

FB 6

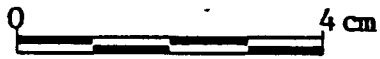
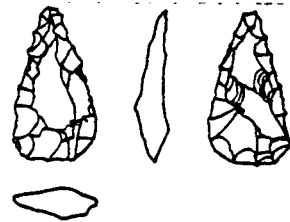

FB 1

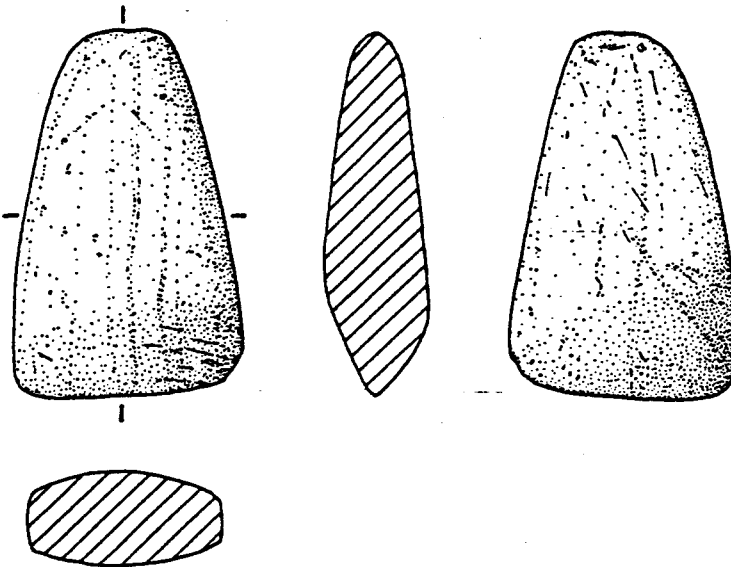

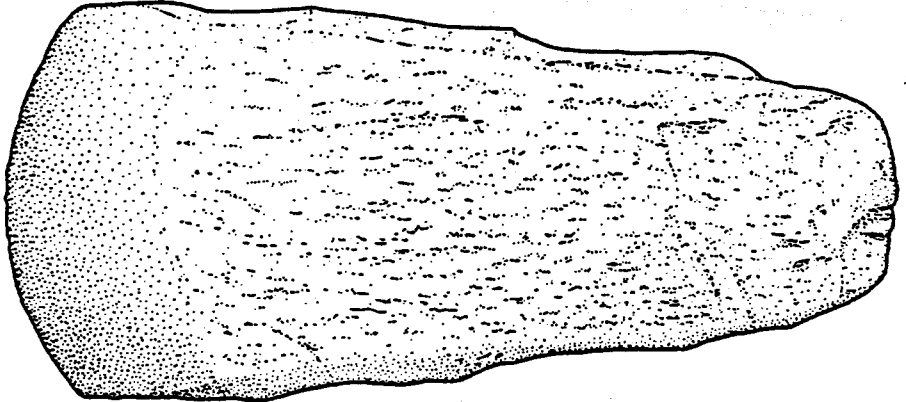
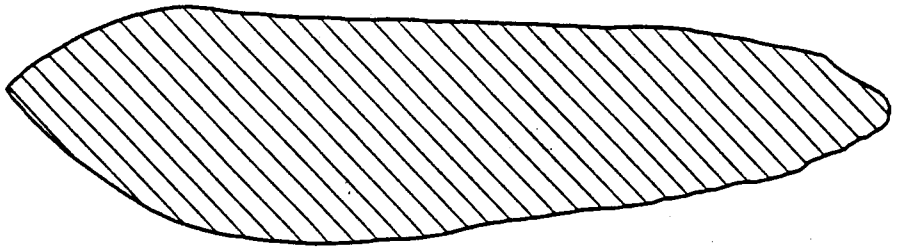
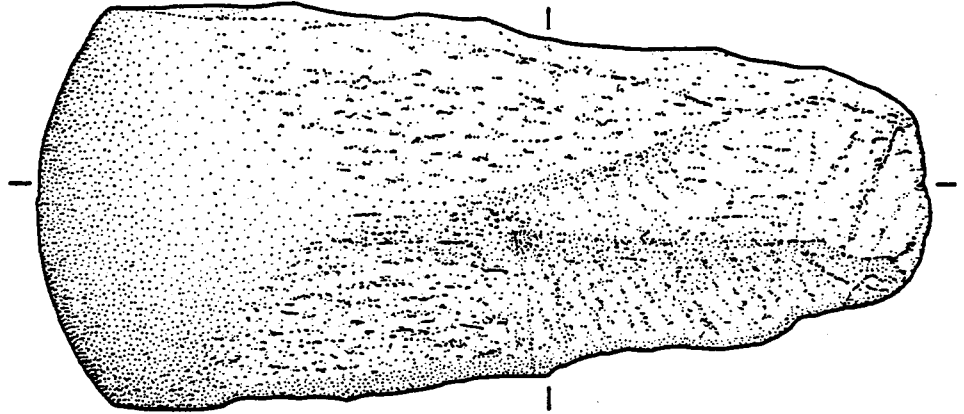
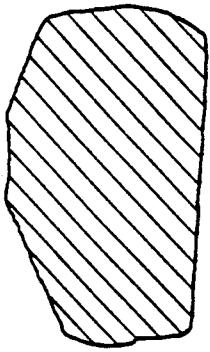

FB3

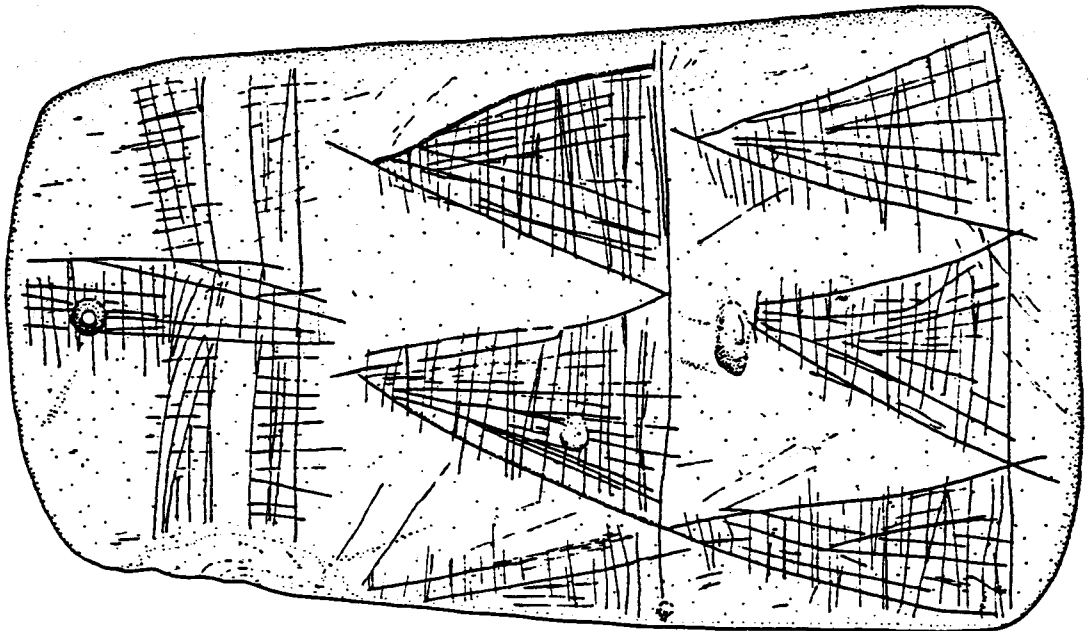
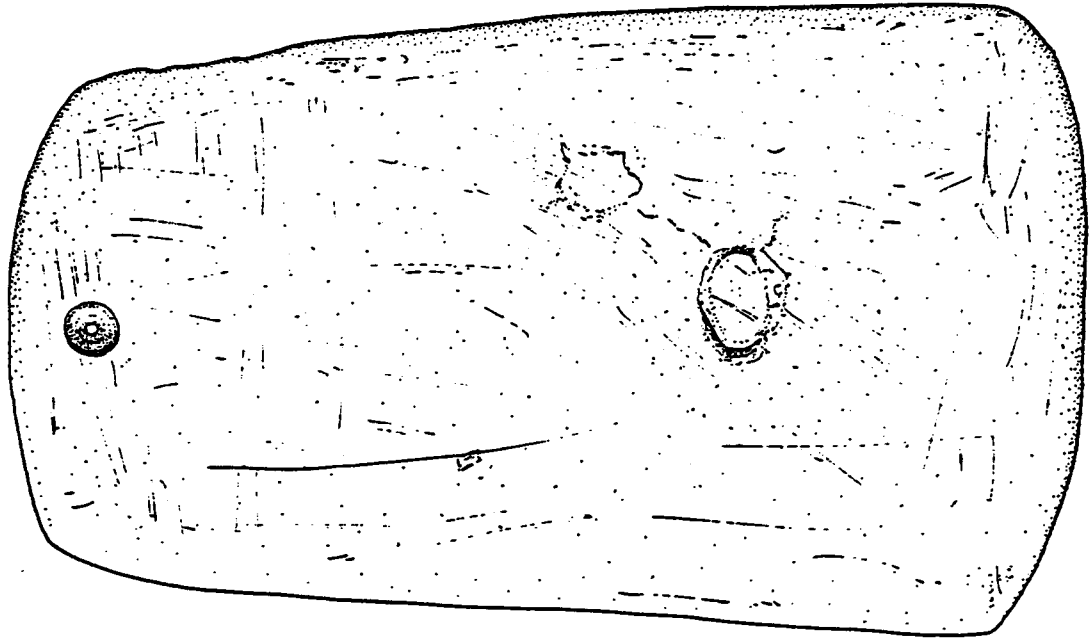

FB 5

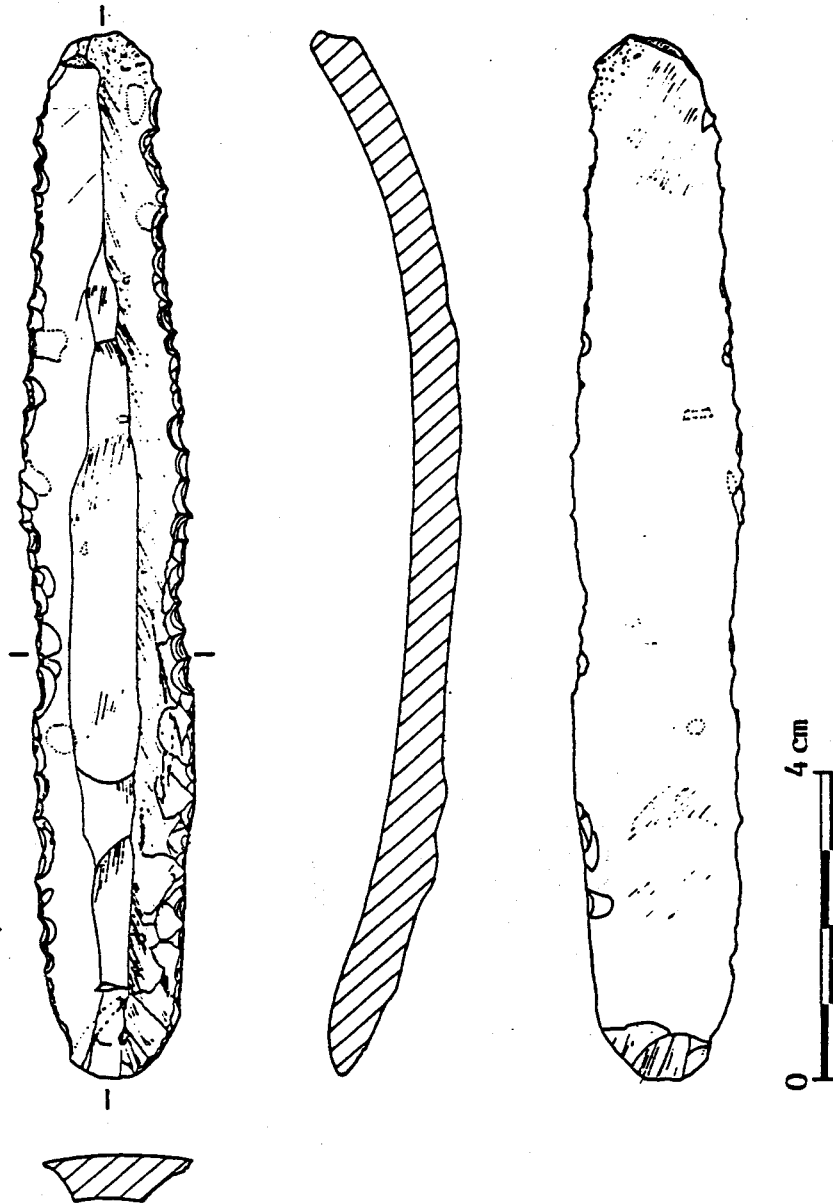

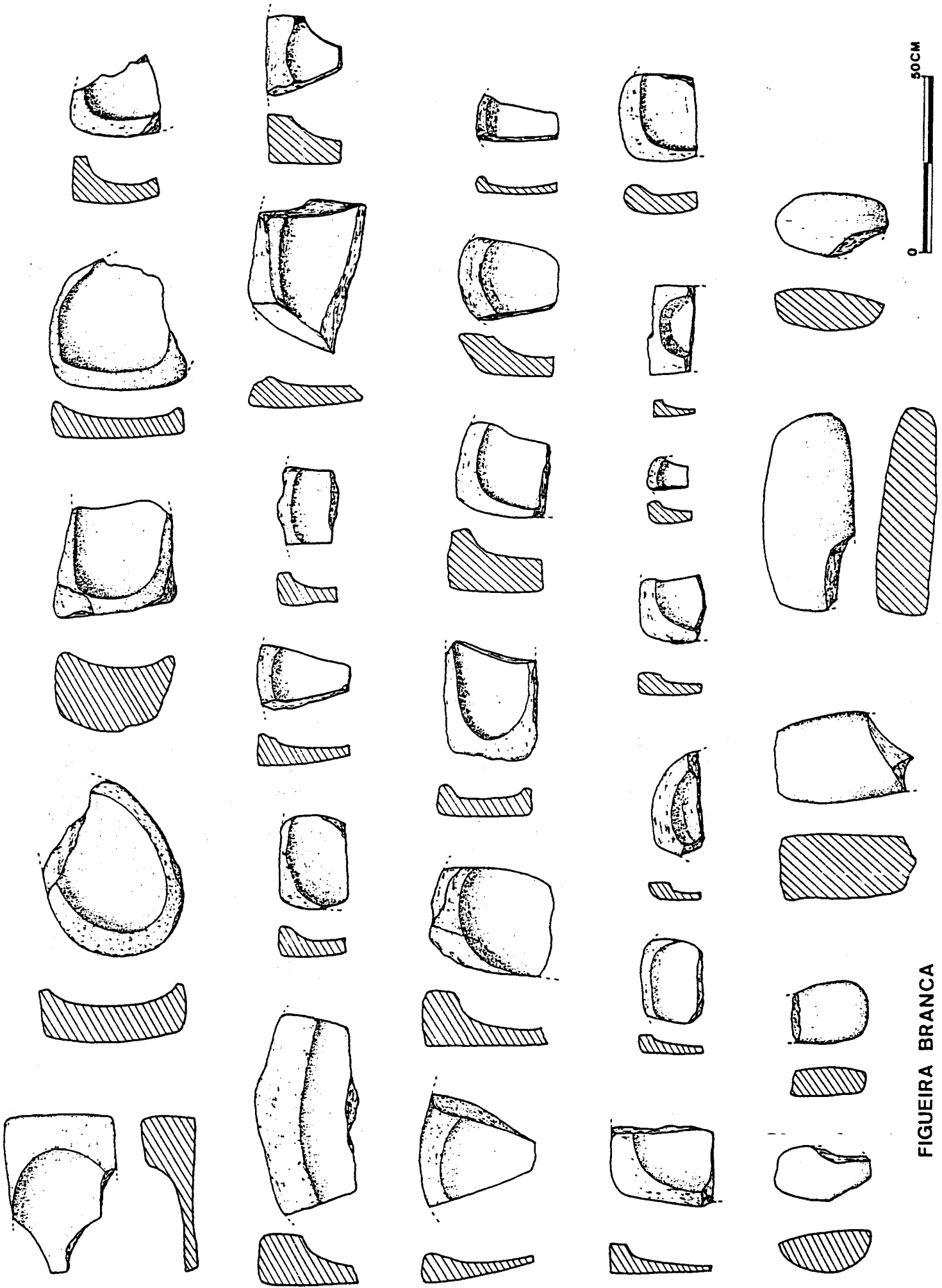

FIGUEIRA BRANCA



ANTA  
dos  
**POMBAIS**





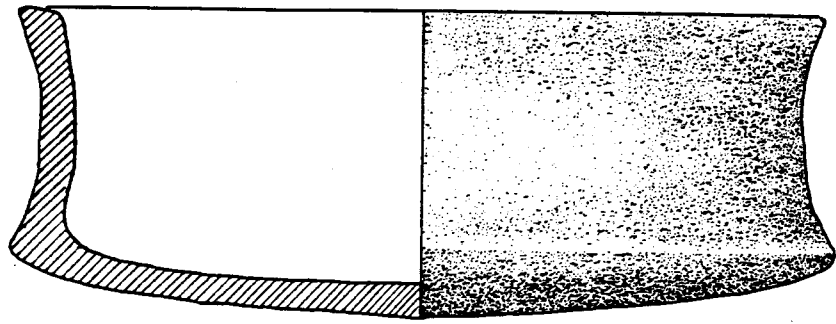

AP 121

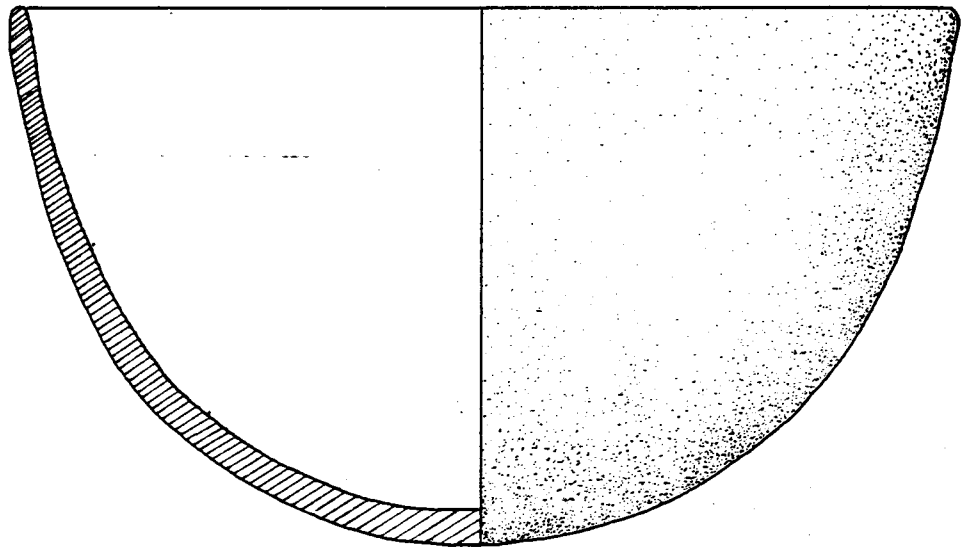

AP 139

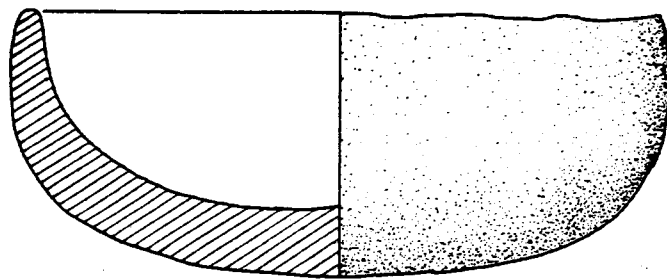

AP 136

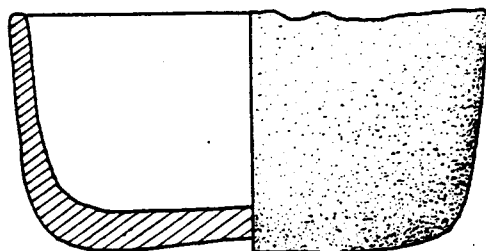

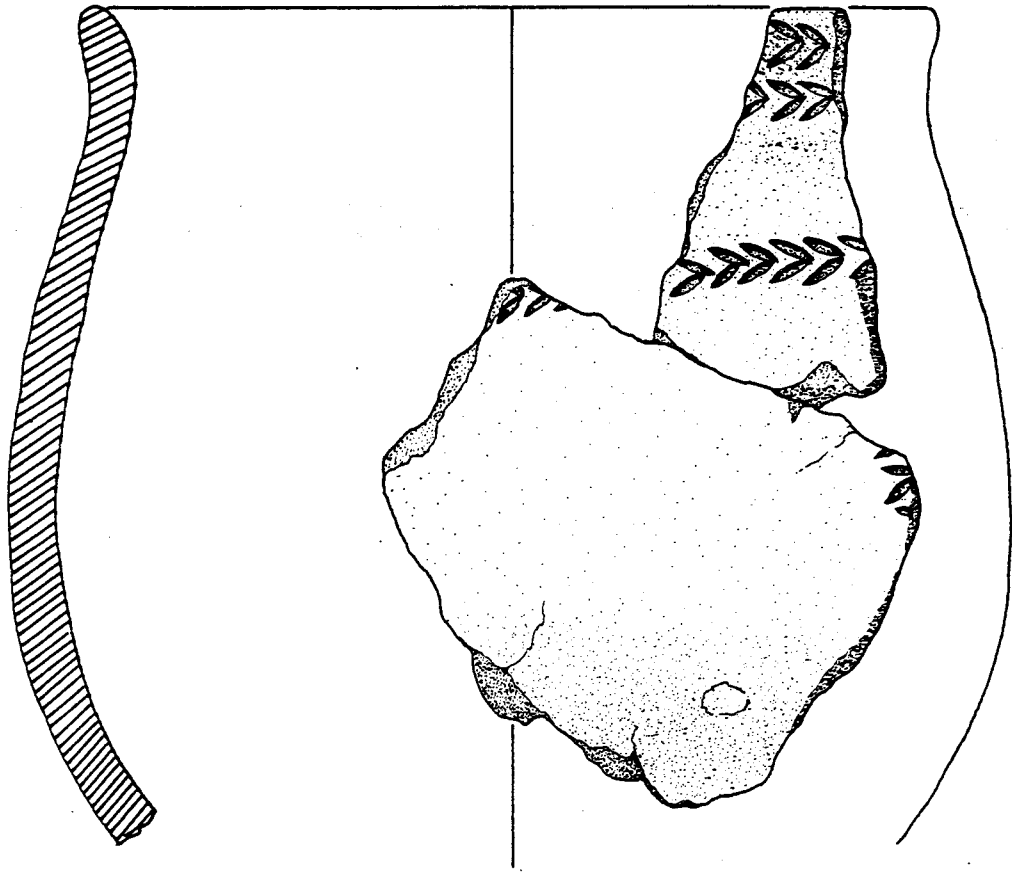

AP 144

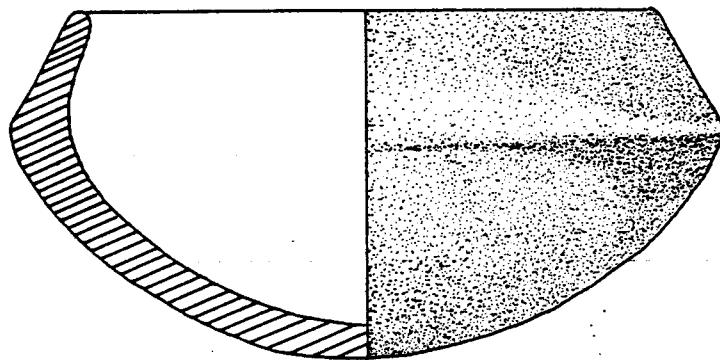

AP 154



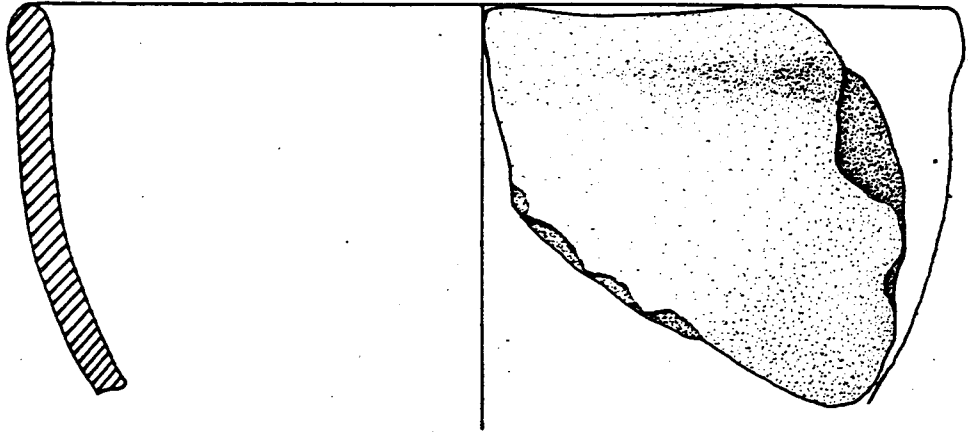

AP 138

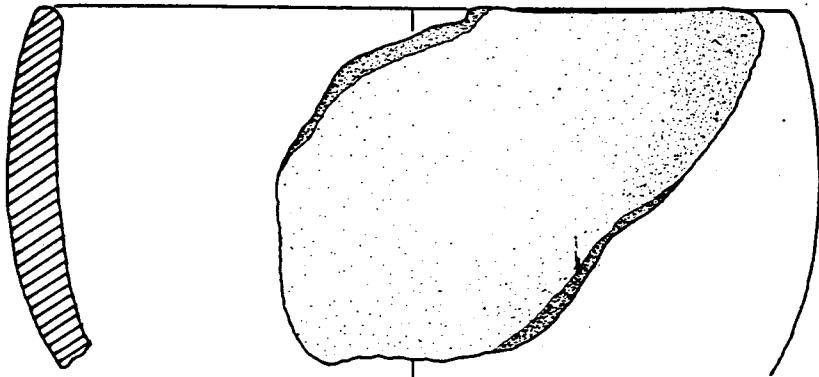

AP 150

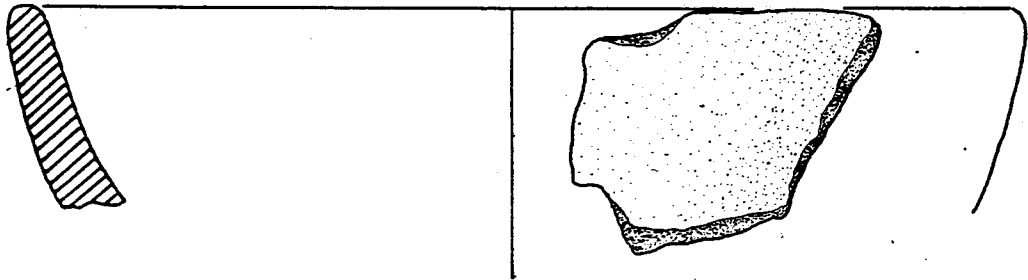

AP 174

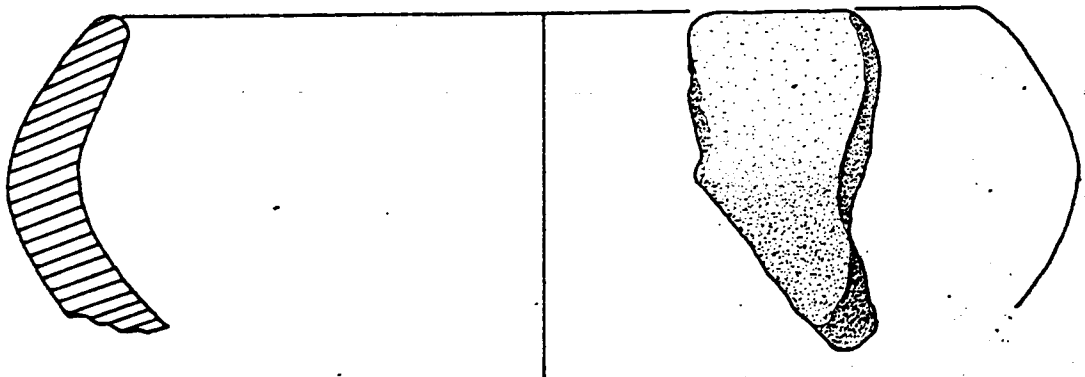

AP 175

0

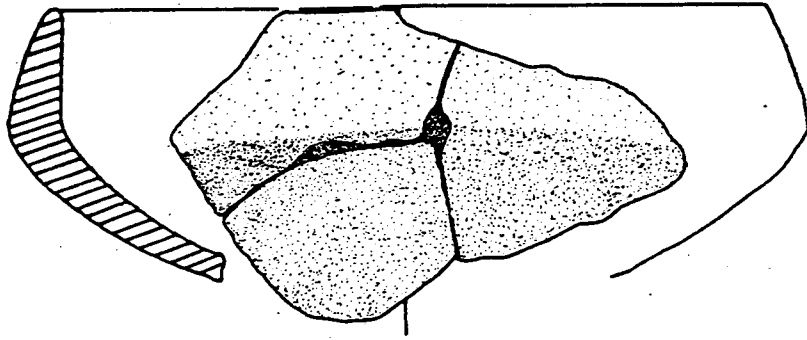

AP 158

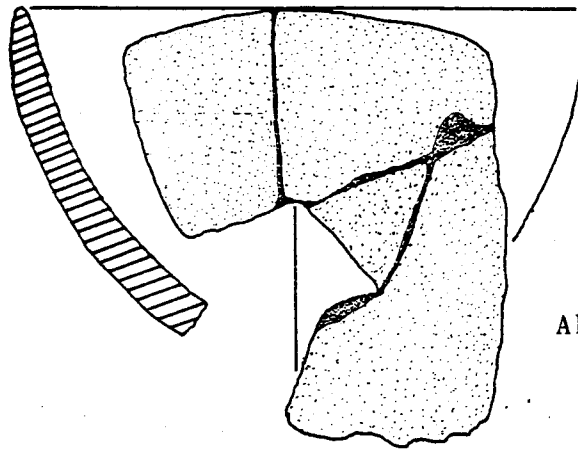

AP 145

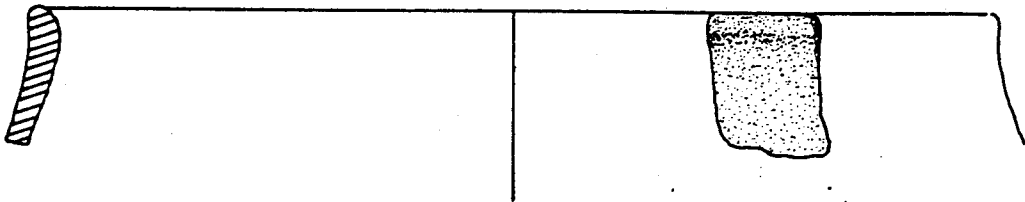

AP 173

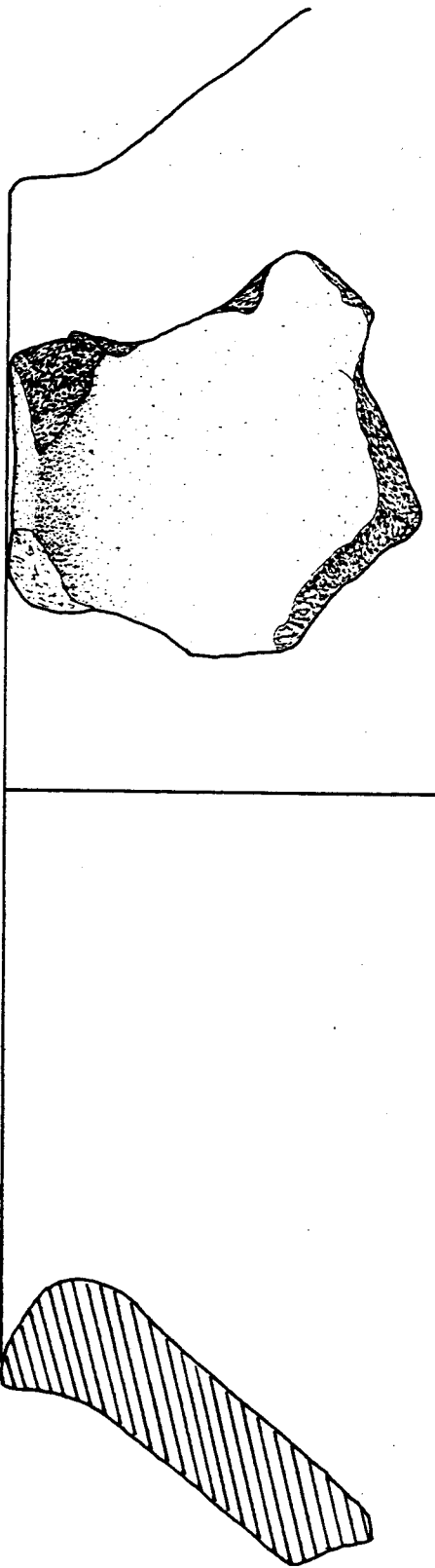

AP 141

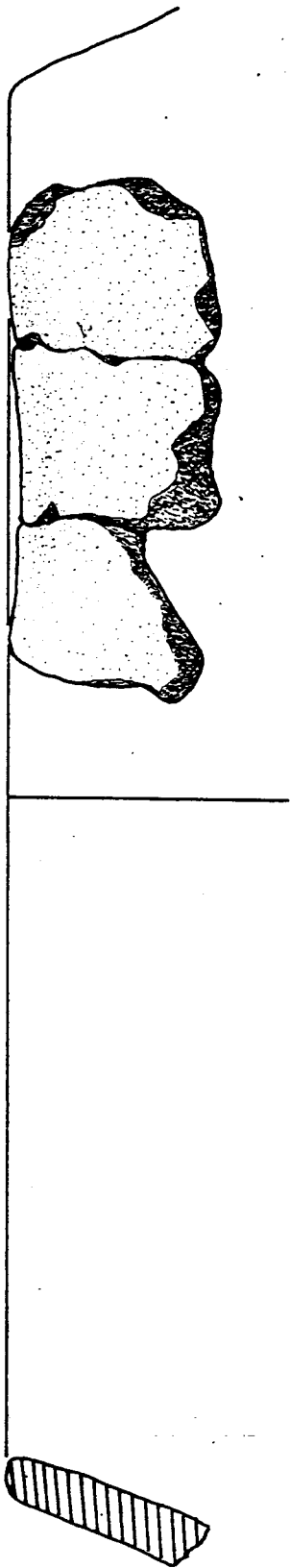

AP 176



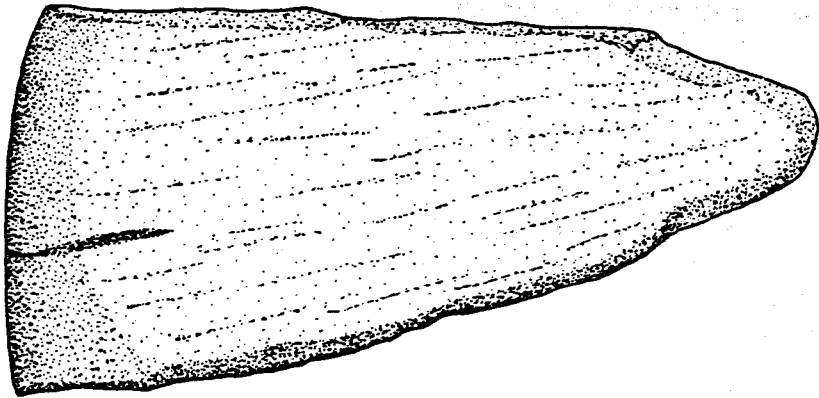
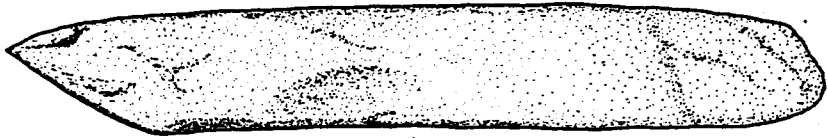
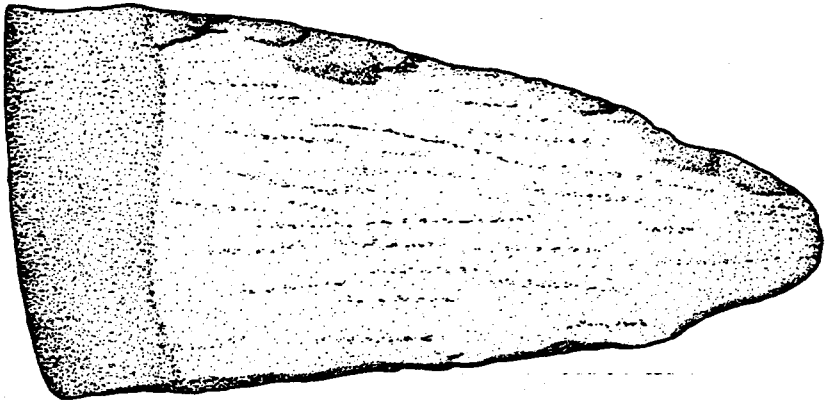
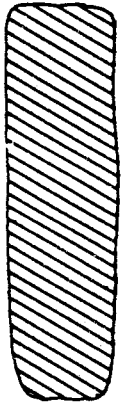

AP 112



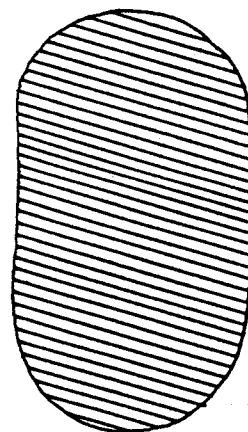
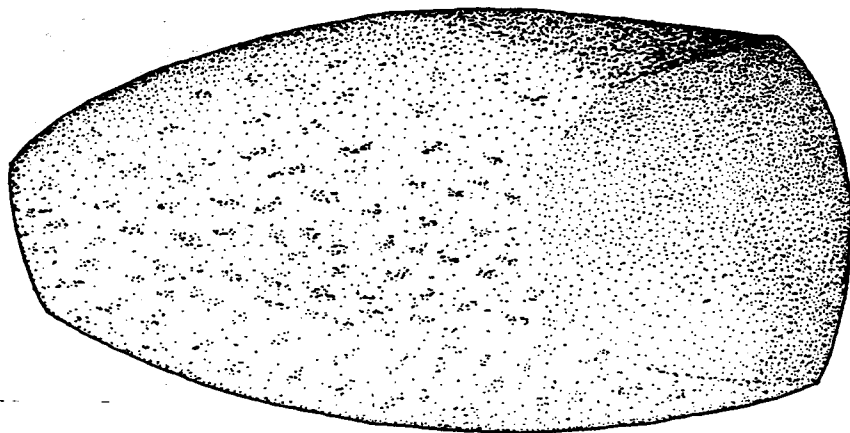
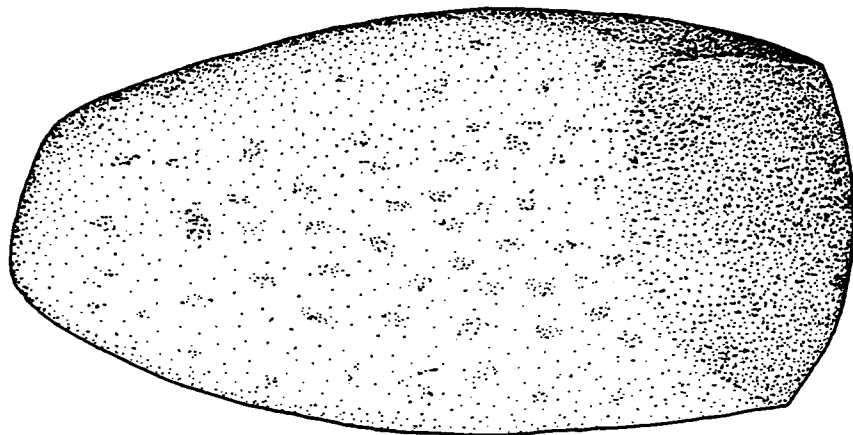

AP 110





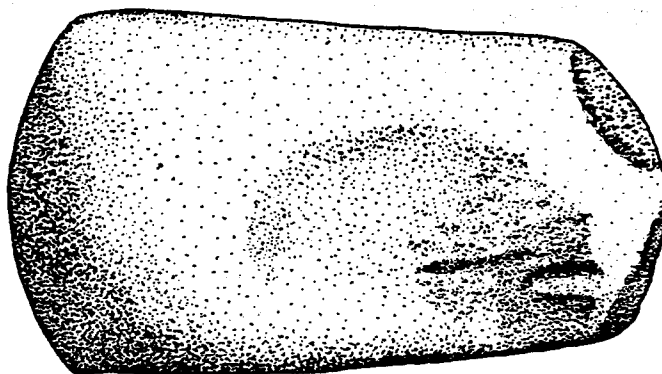
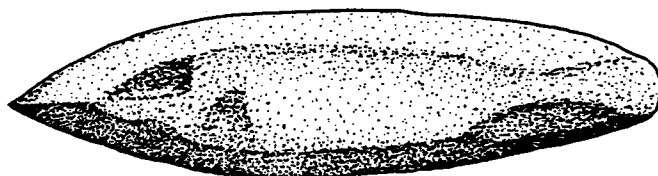
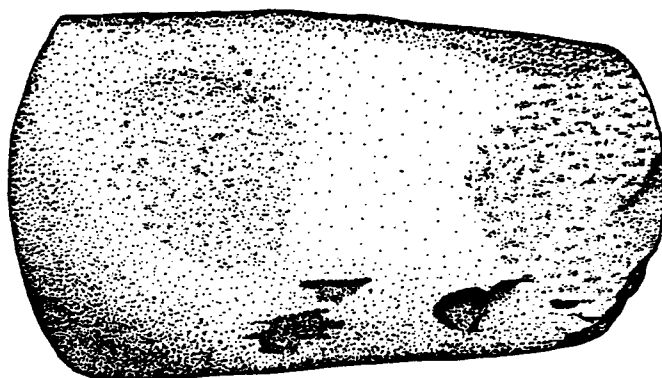
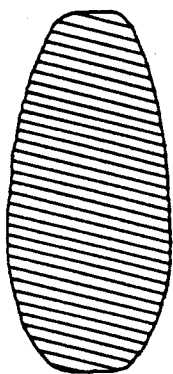

AP 1111



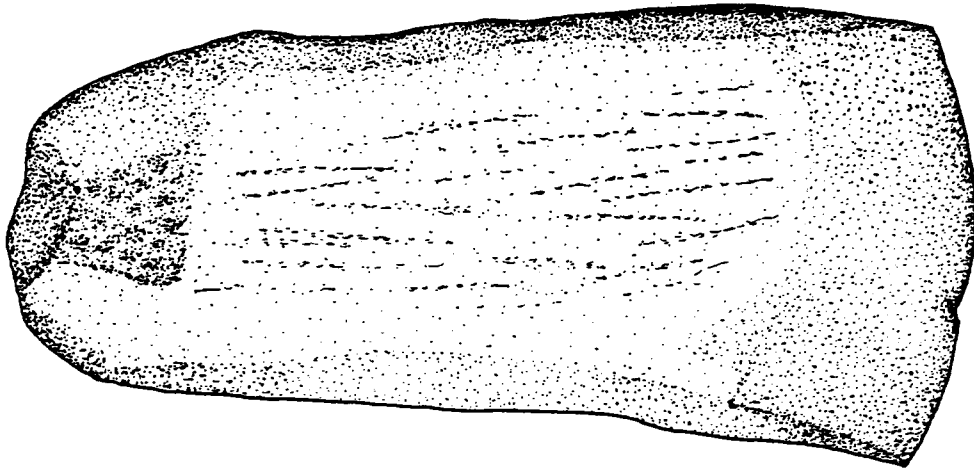

AP 108

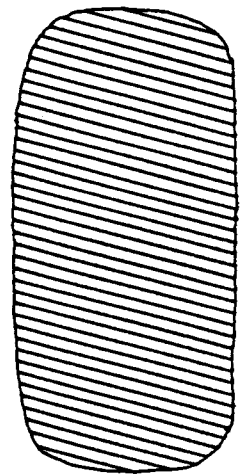
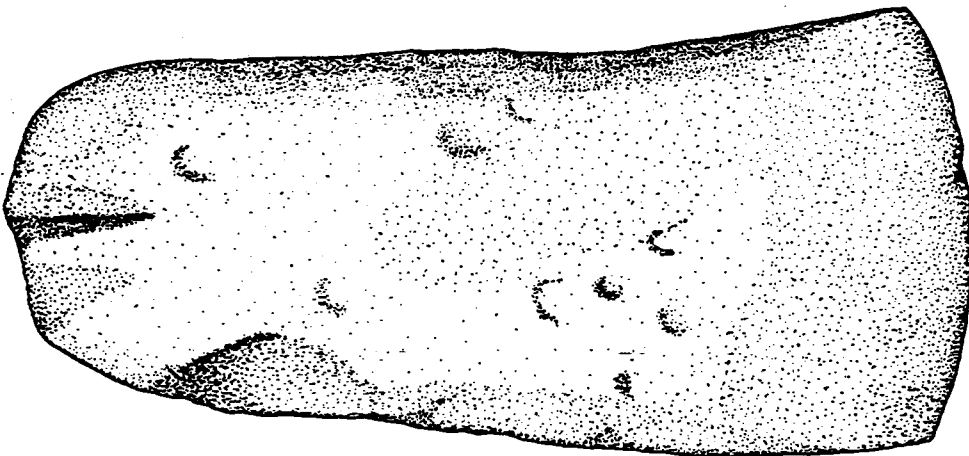
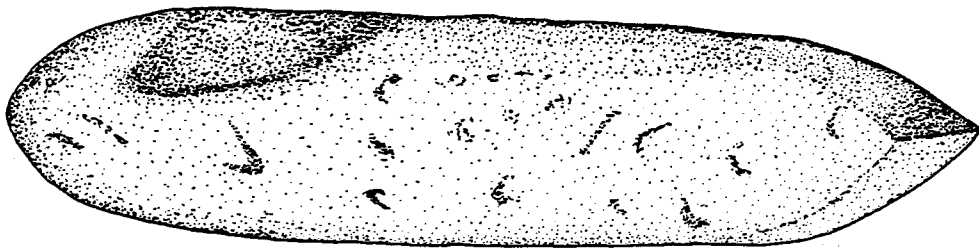

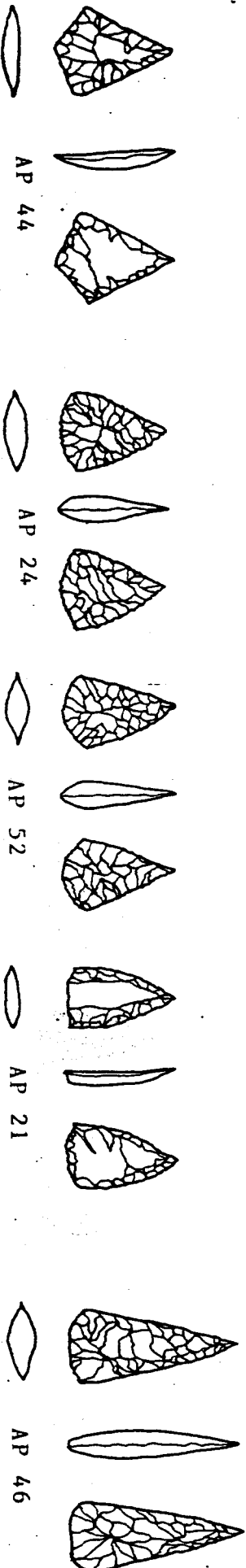
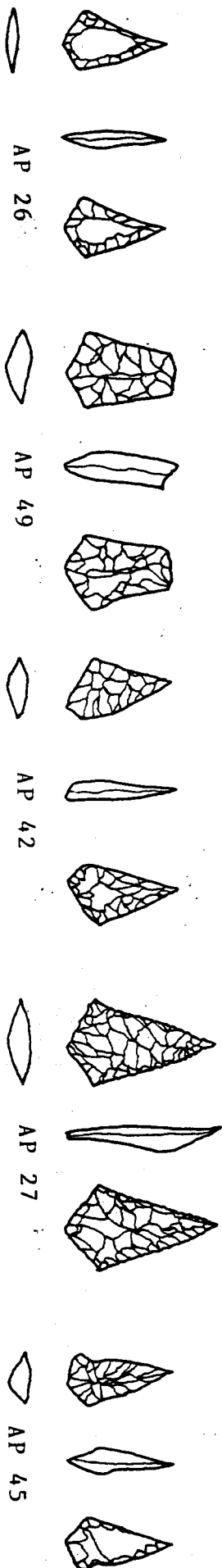
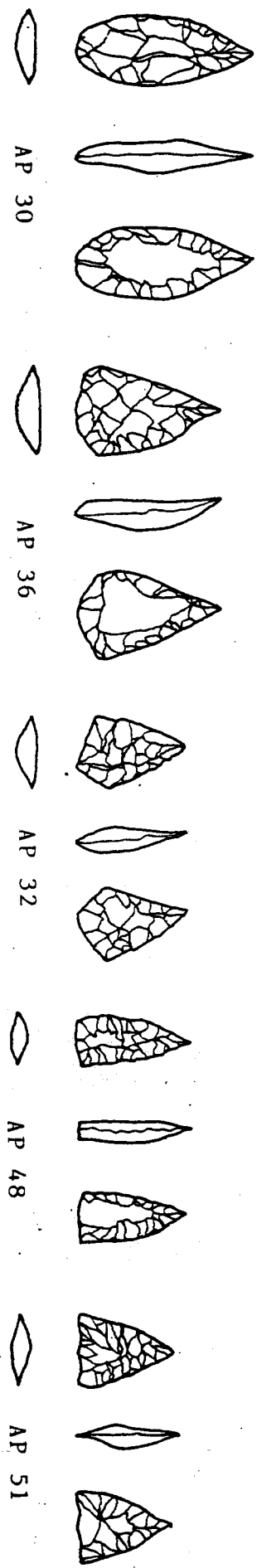

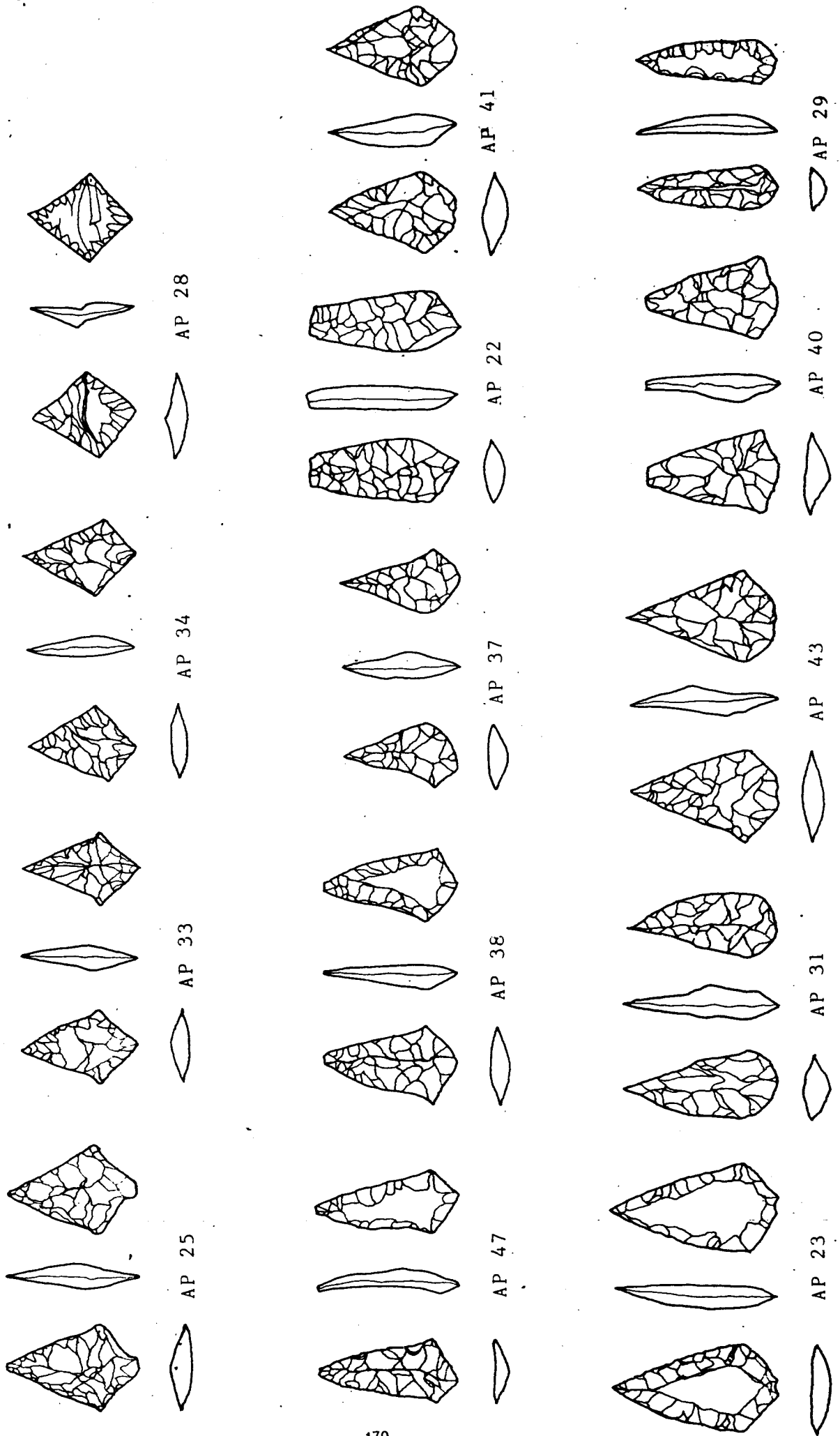



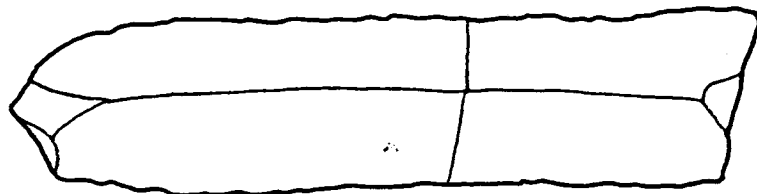
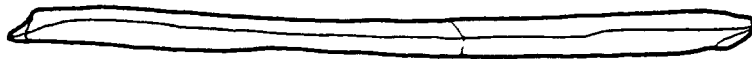
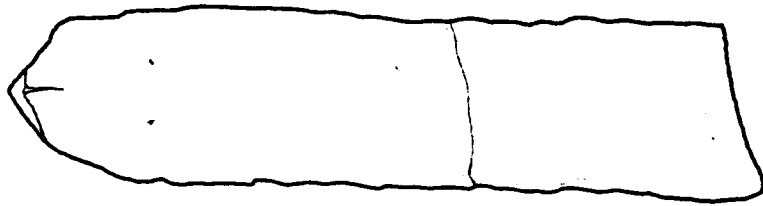
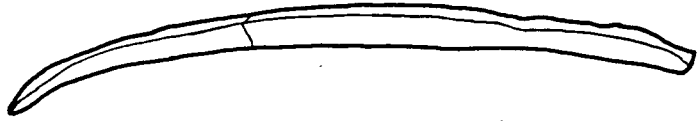
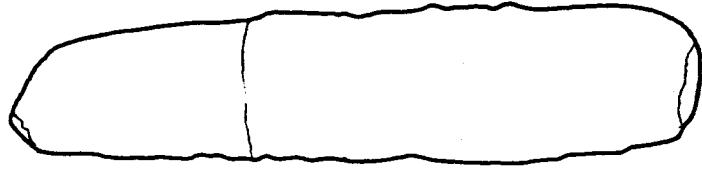

AP 19

AP 18



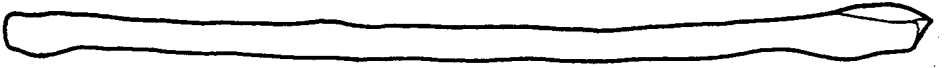
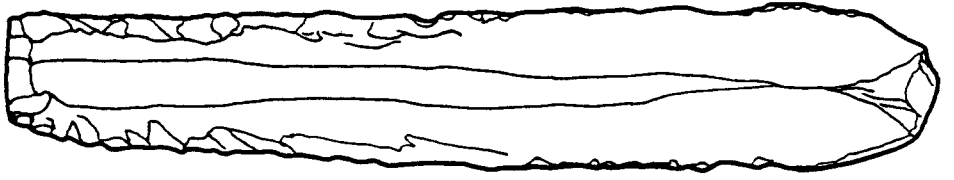

AP 16

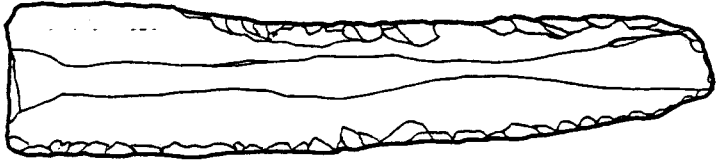
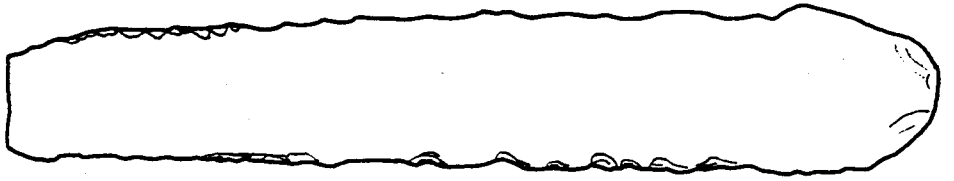

AP 17

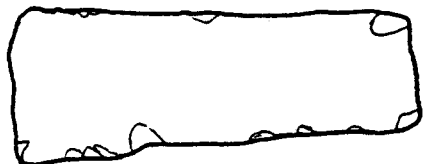
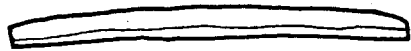
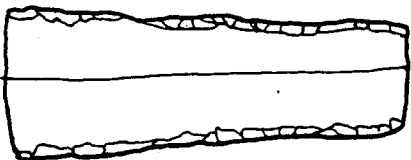
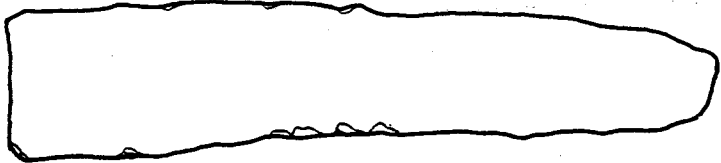

AP 20



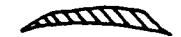

AP 6

AP 7

AP 5

AP 171

AP 2

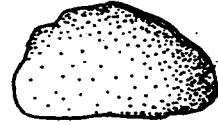

AP 9



AP 13

AP 4

AP 1

AP 3





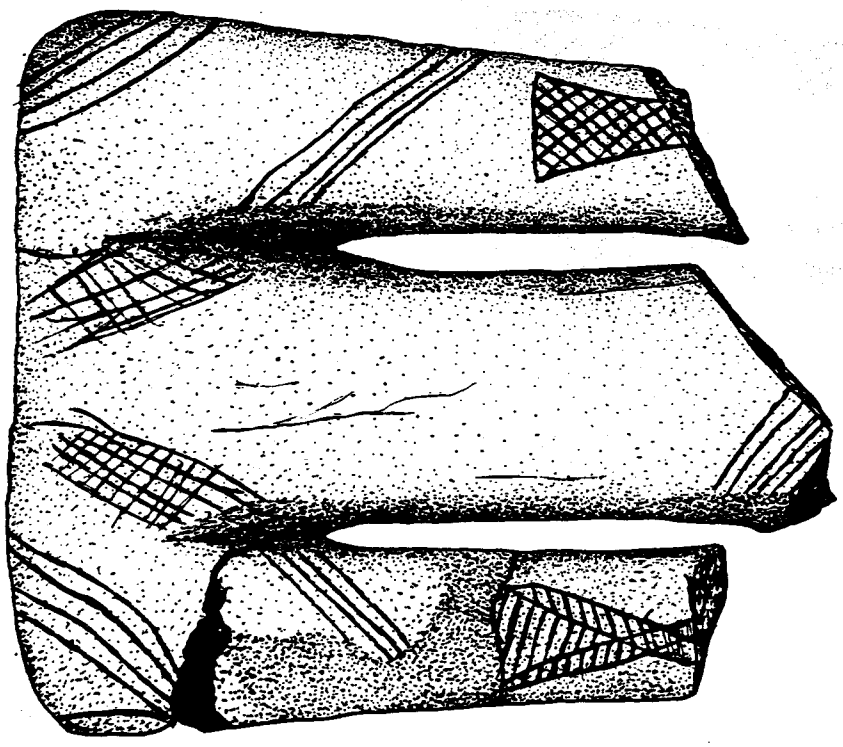
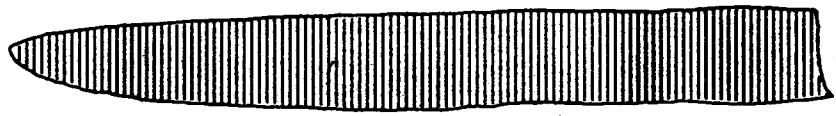
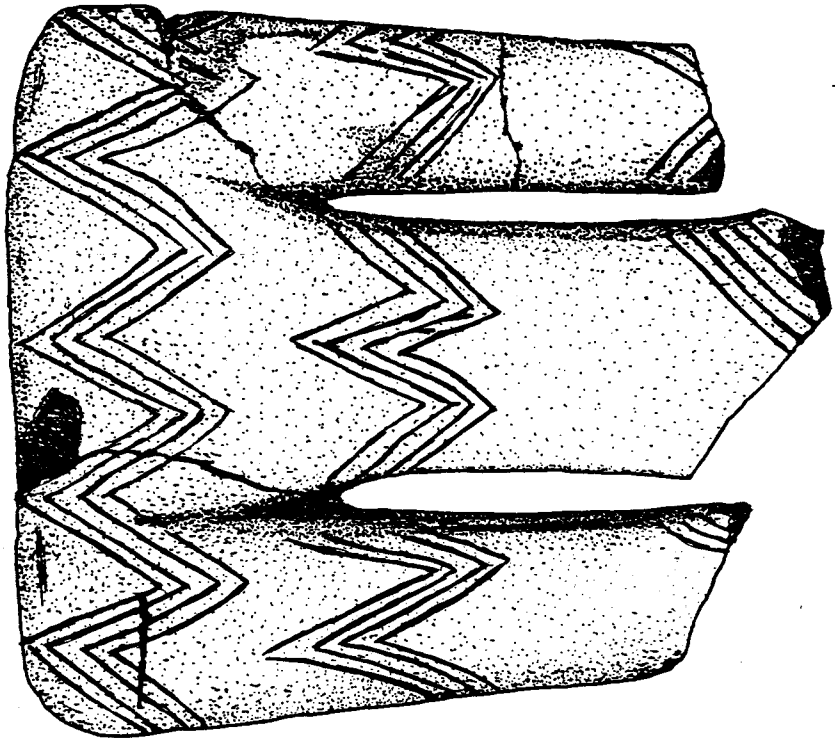

AP 105



0 5

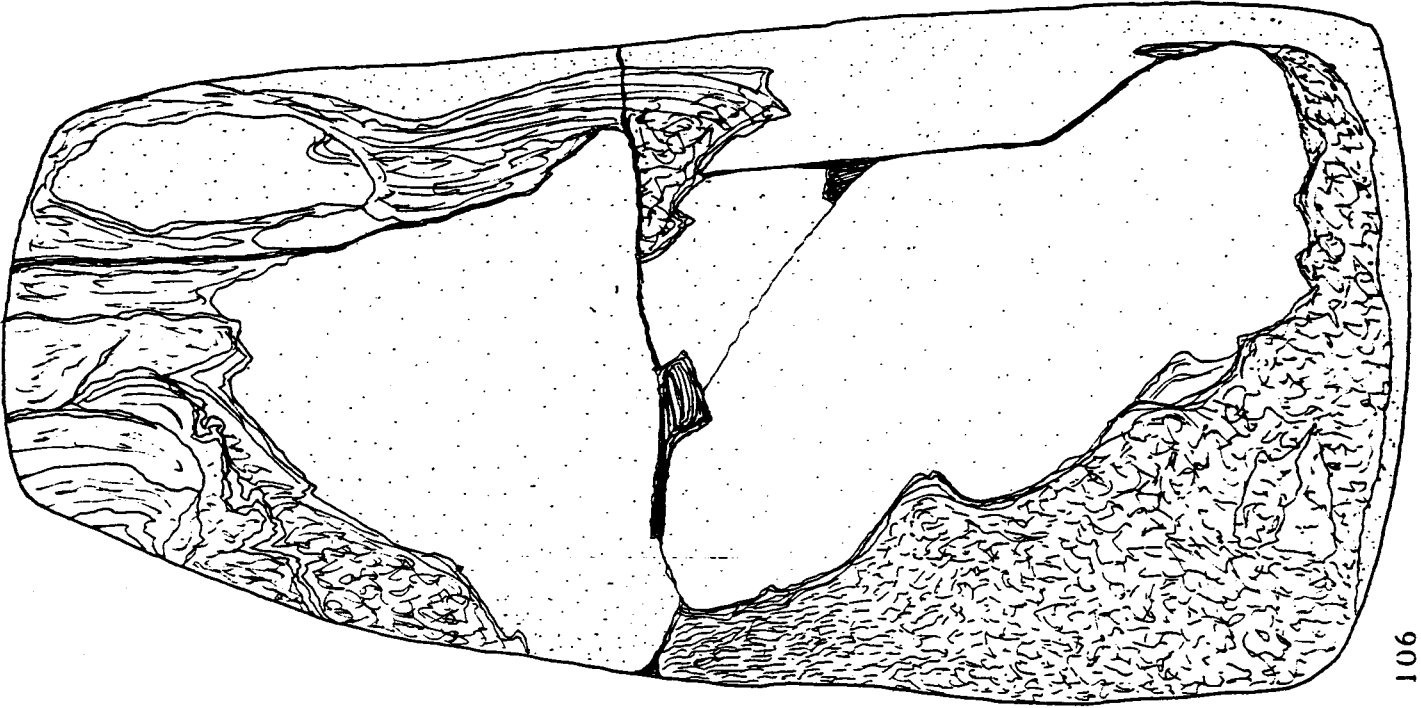

AP 106

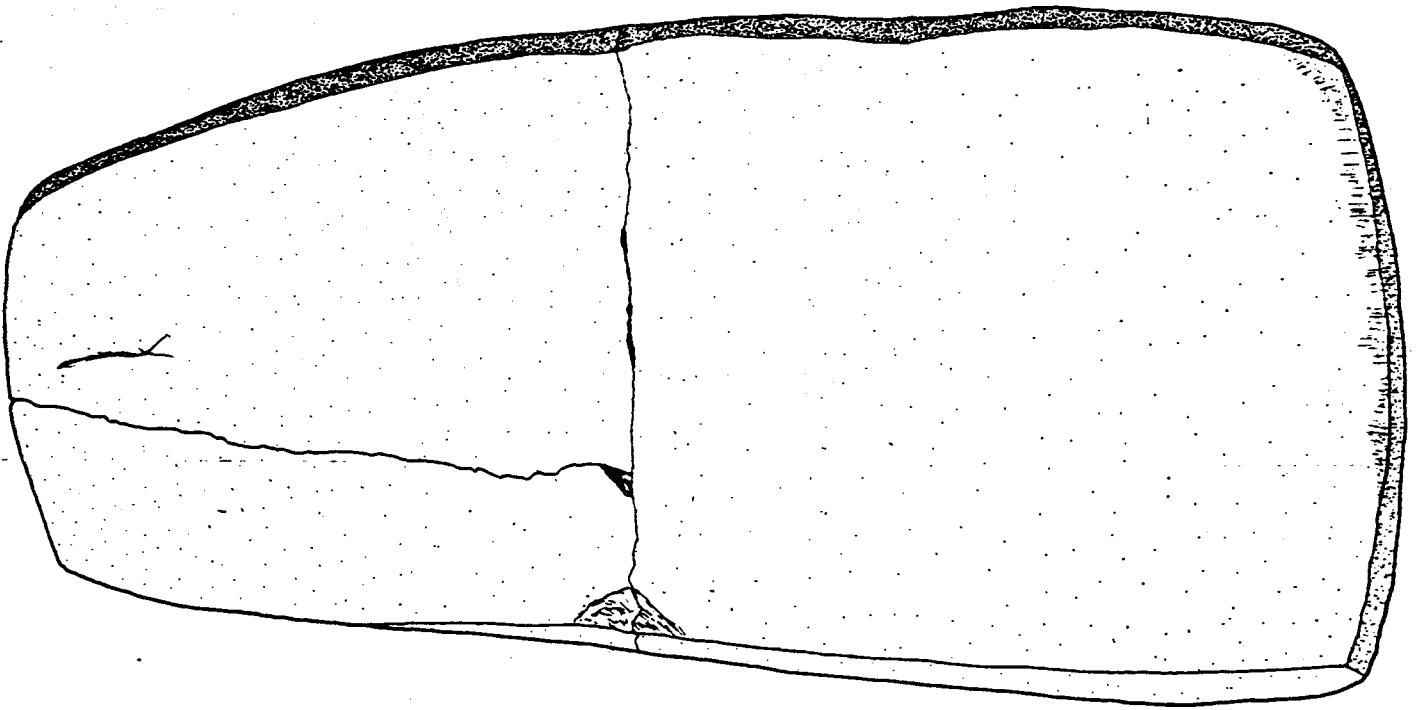
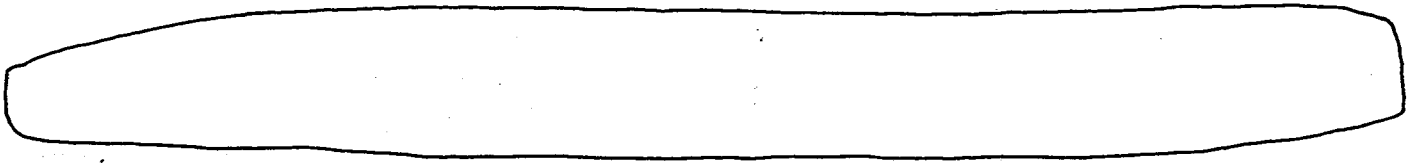

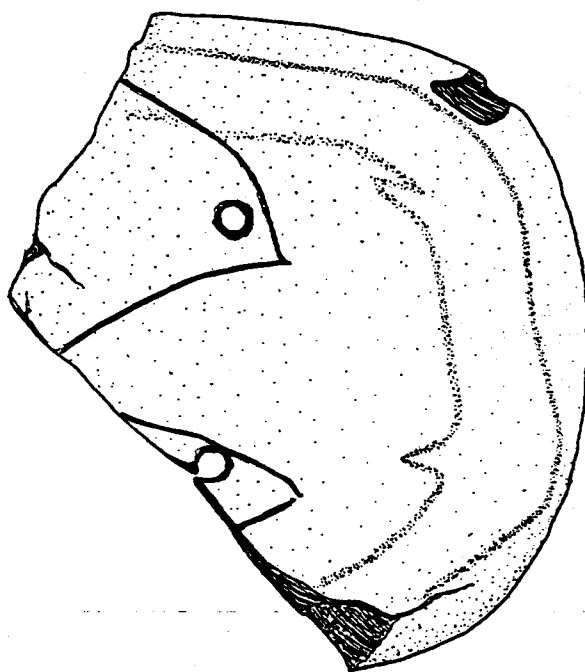
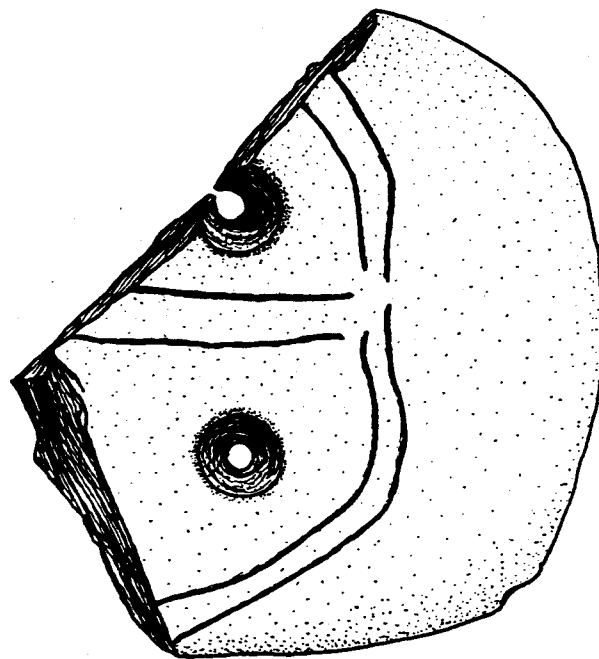

AP 104



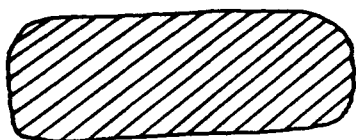
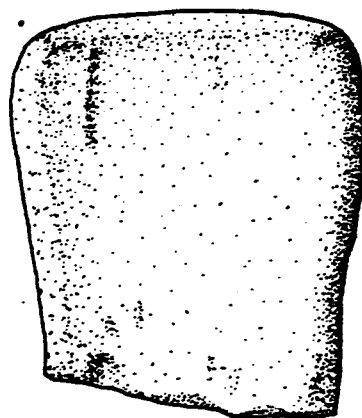
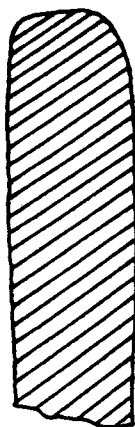
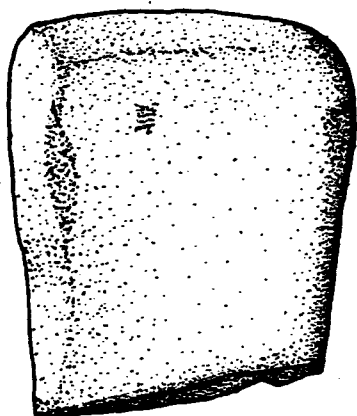

AP 135



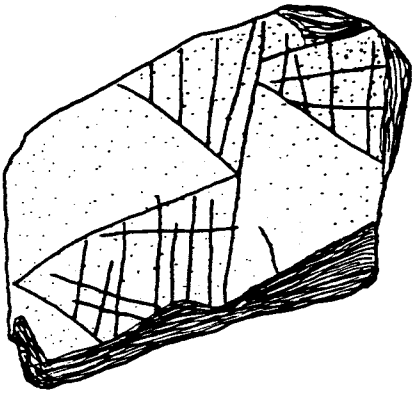

AP 101

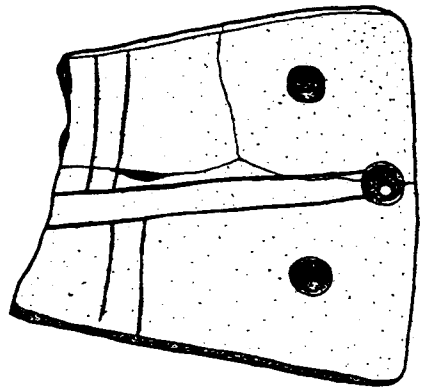
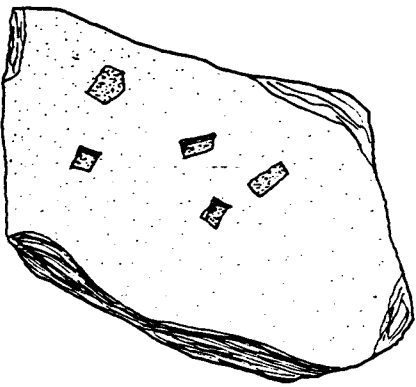

AP 103

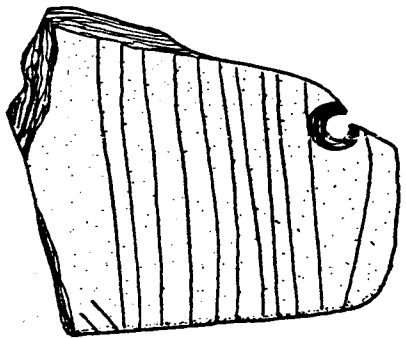
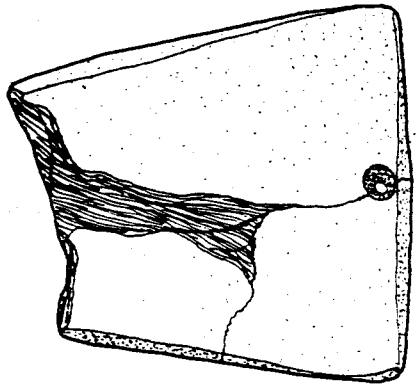

AP 98

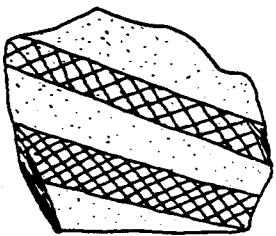
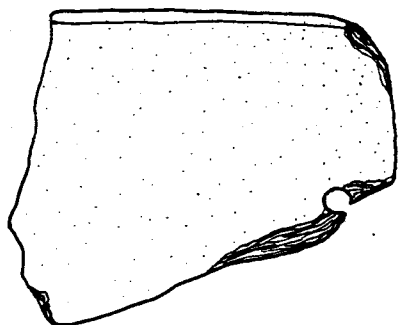

AP 99

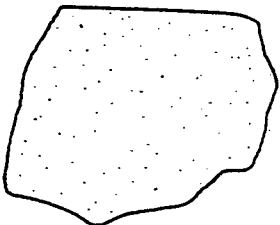

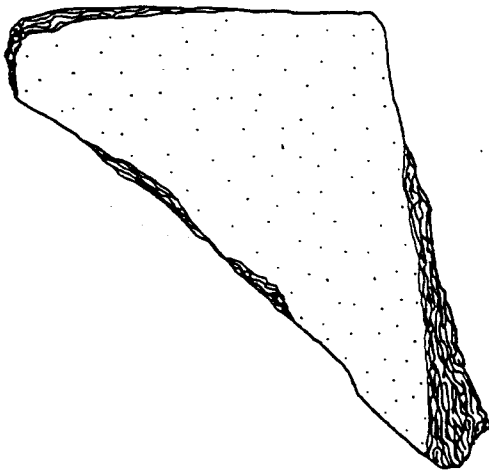
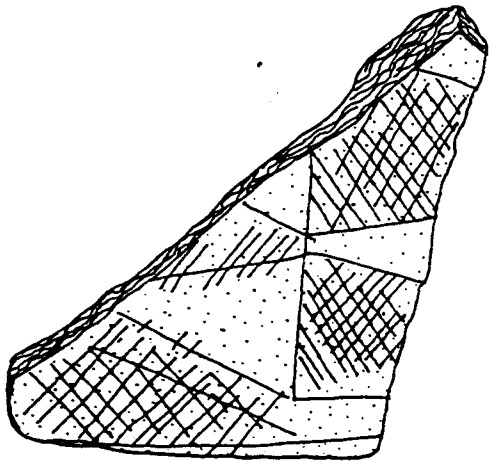

AP 102

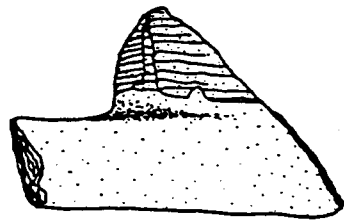
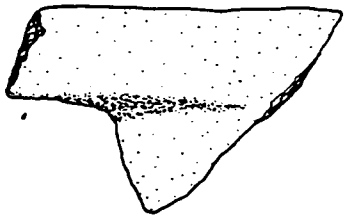

AP 107

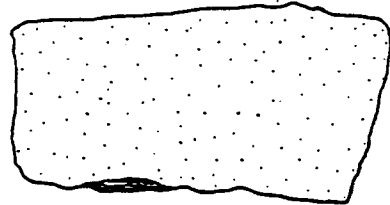
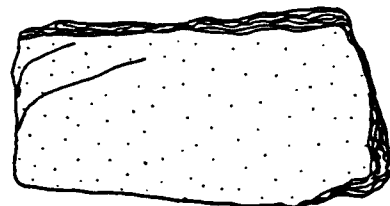

AP 96



AP 100

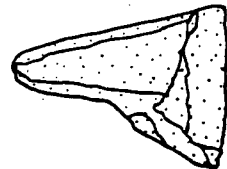
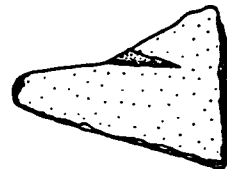

AP97



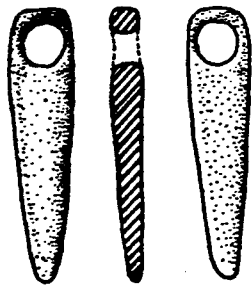

AP 94

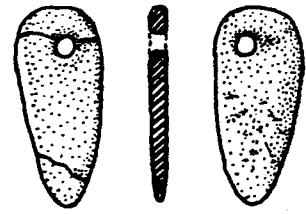

AP 95



AP 91



AP 90



AP 93



AP 66



AP 78



AP 92



AP 77

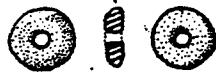

AP 71



AP 80



AP 170

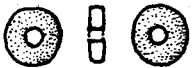

AP 67



AP 87

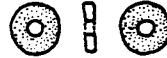

AP 79



AP 68



AP 84



AP 70



AP 74



AP 86



AP 85

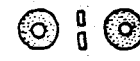

AP 63



AP 83



AP 82



AP 69



AP 58



AP 64



AP 76



AP 56



AP 60

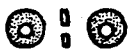

AP 81



AP 65



AP 52



AP 59



AP 61



AP 57



AP 54

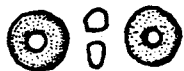

AP 88



AP 89

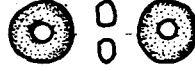

AP 75



AP 72



AP 73



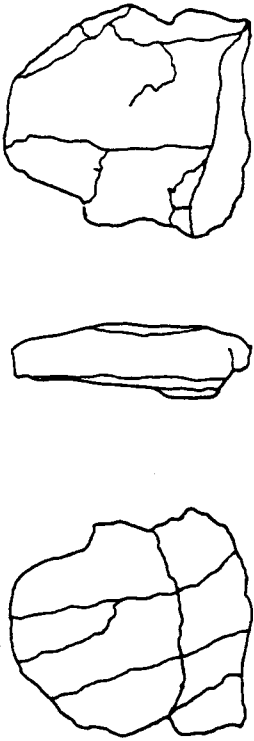

AP 14

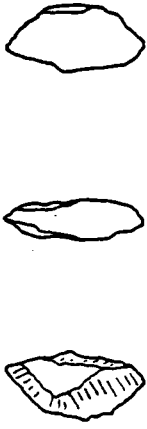

AP 11



AP 12



AP 10





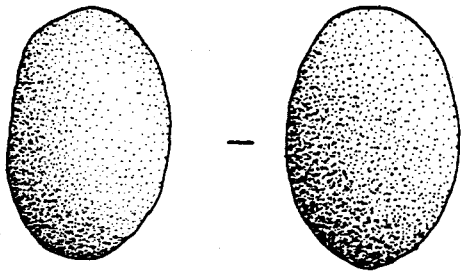

AP 128

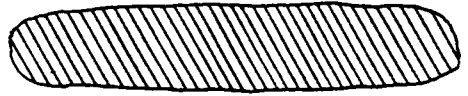
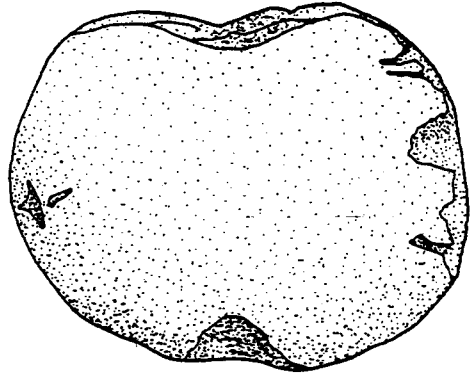
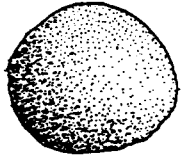

AP 126

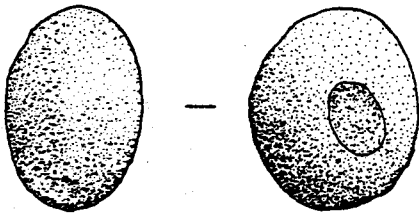
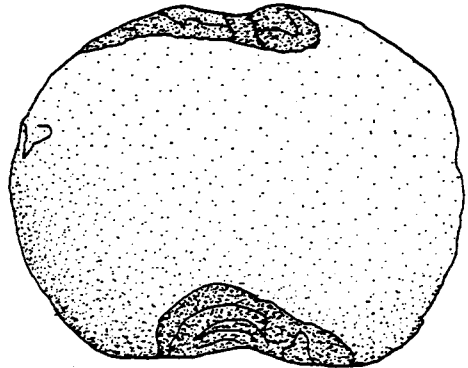

AP 130

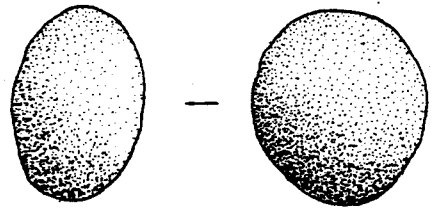
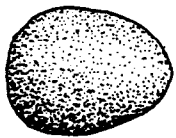

AP 129

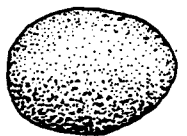

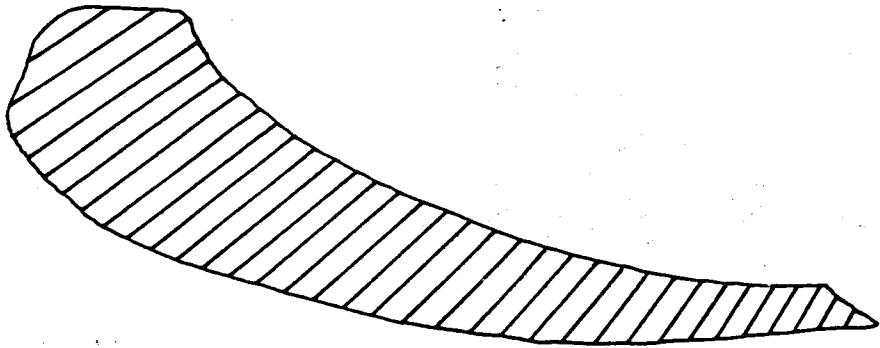
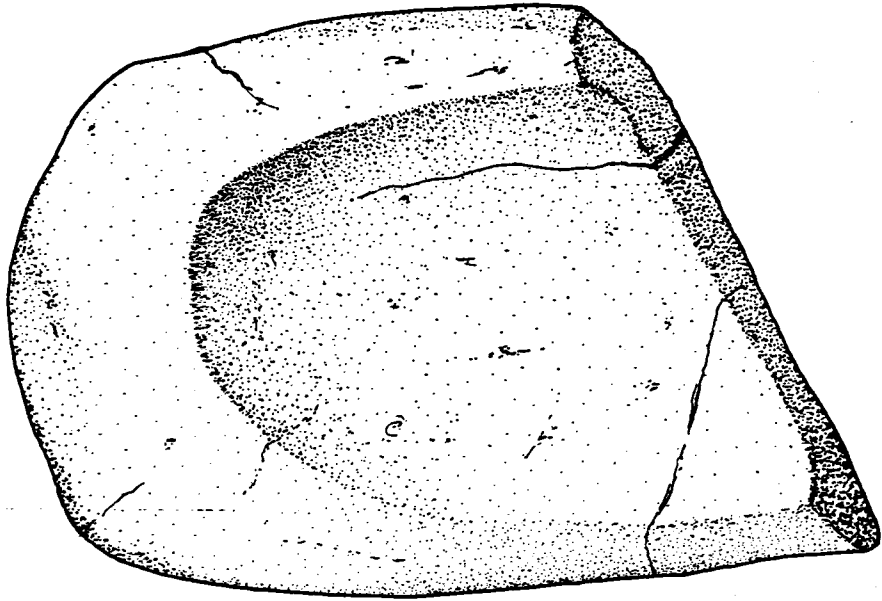



**ANTA**  
**I do ALCOGULO**



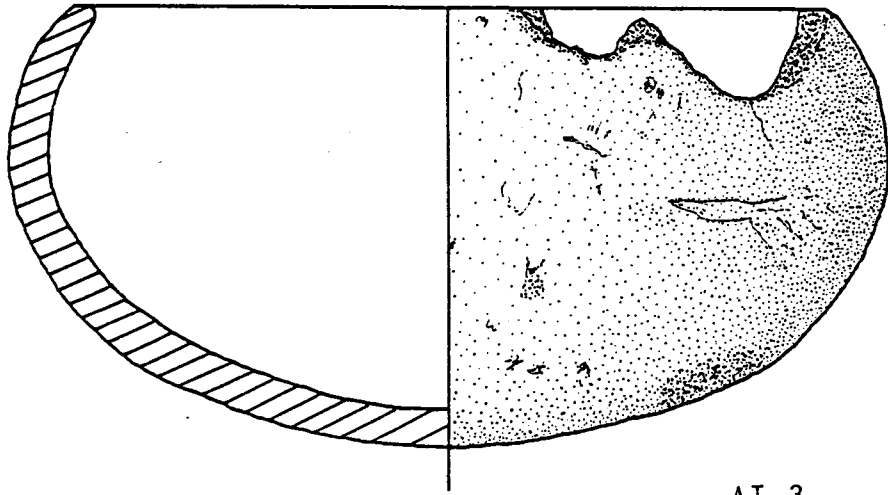

AI 3

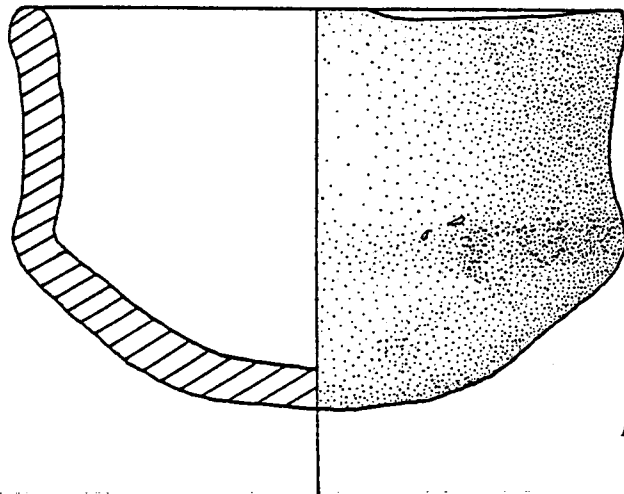

AI 1



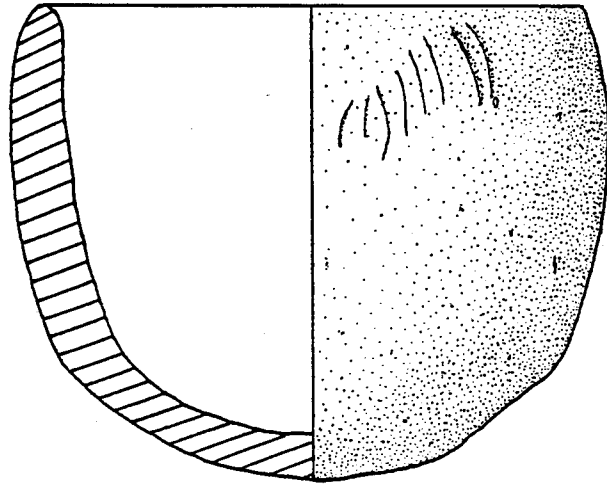

AI 10

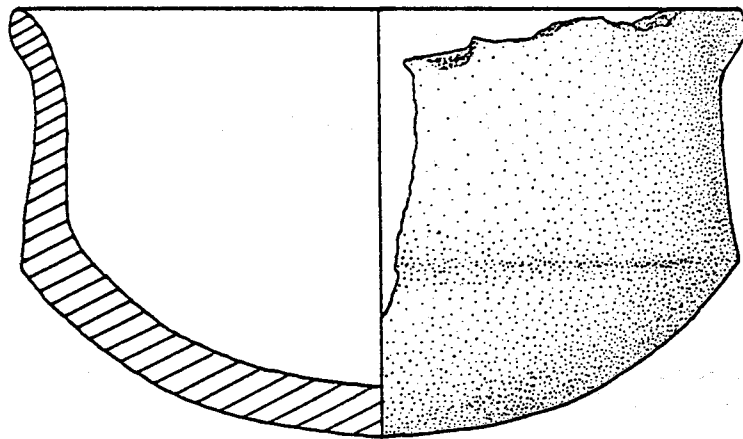

AI 9



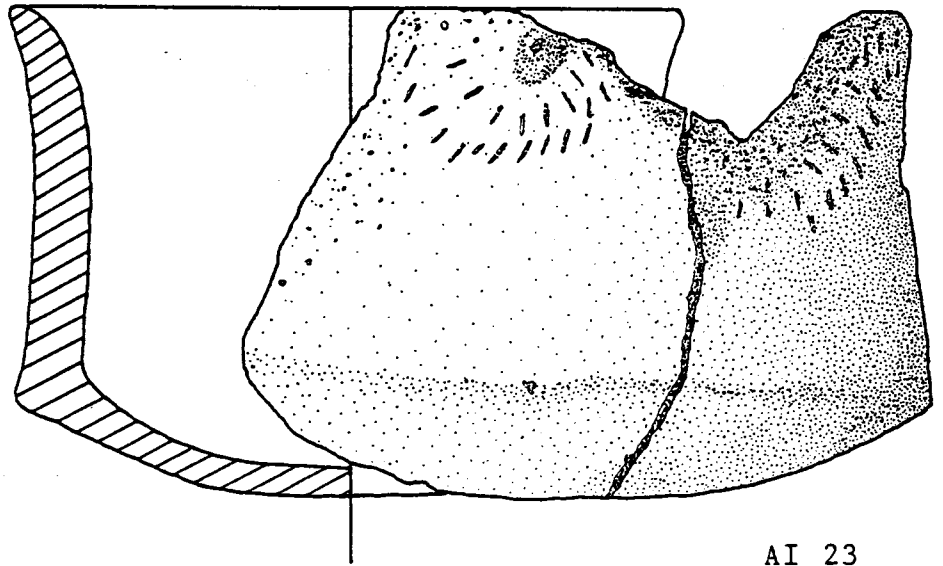

AI 23

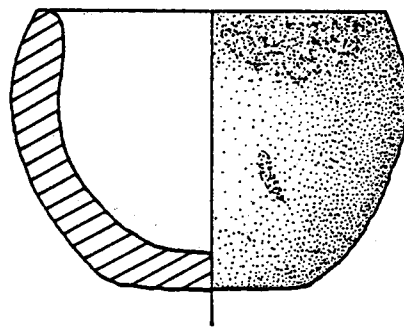

AI 22





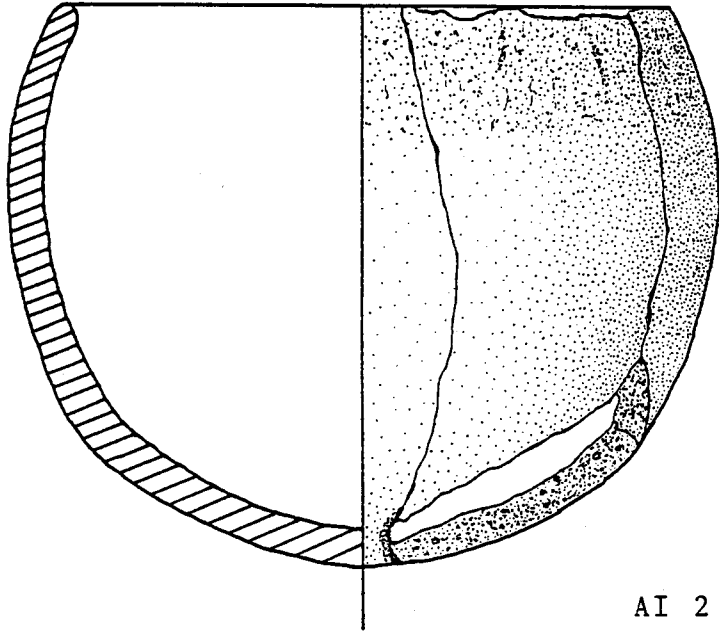

AI 2

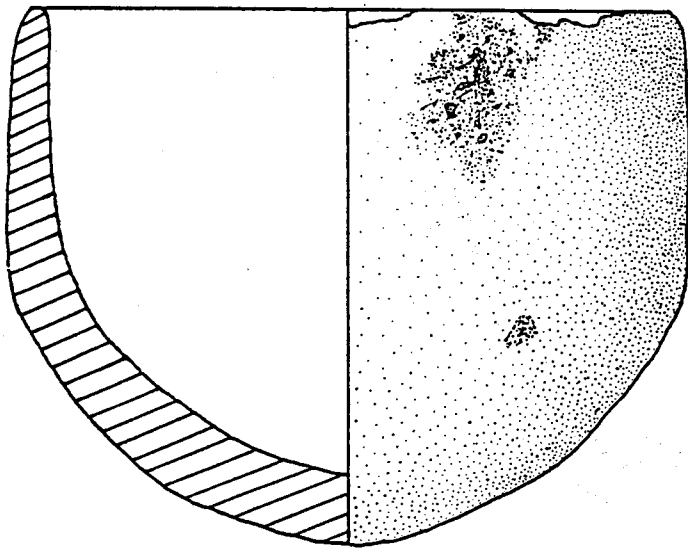

AI 6



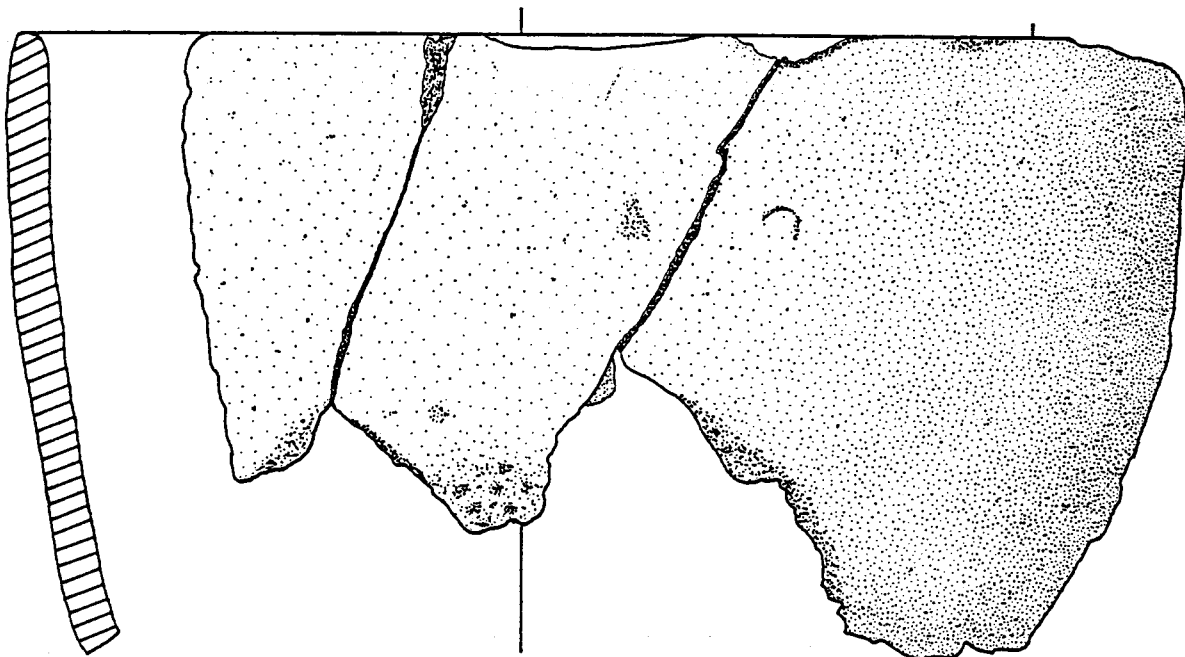

AI 12

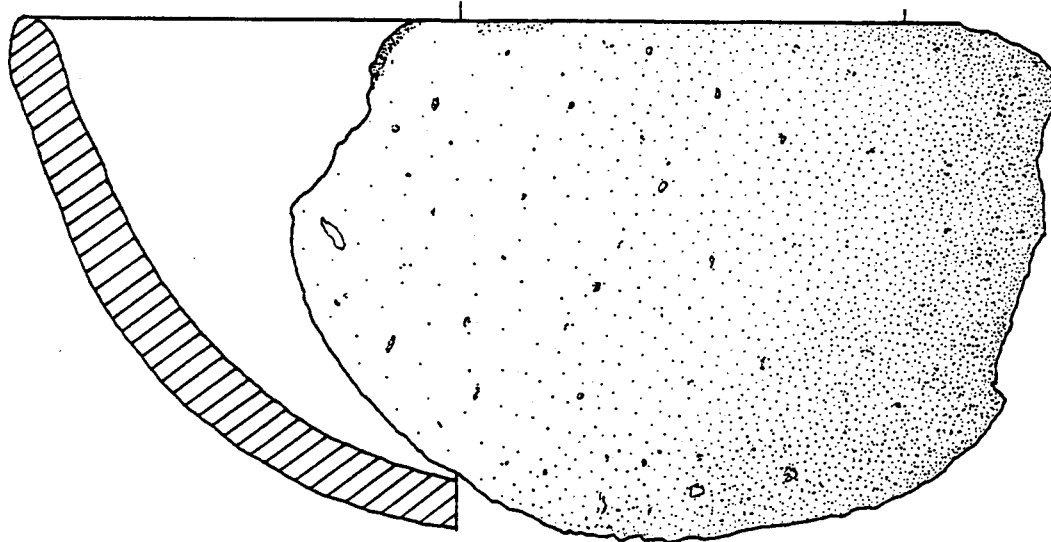

AI 16



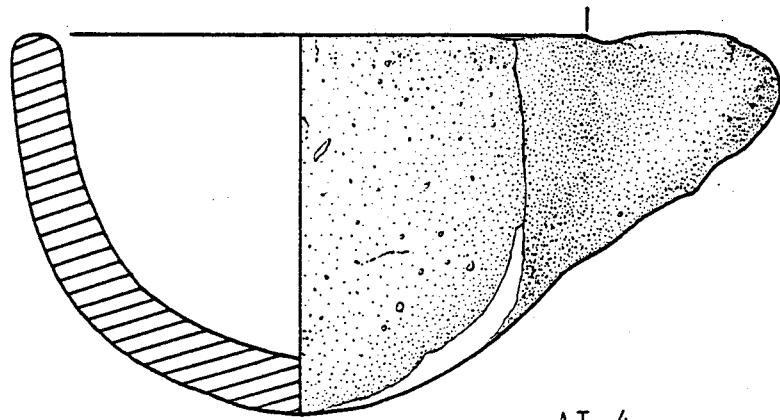

AI 4

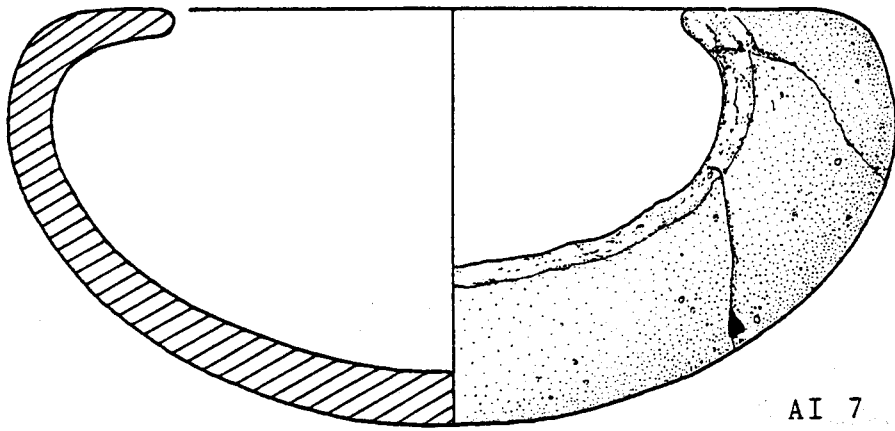

AI 7

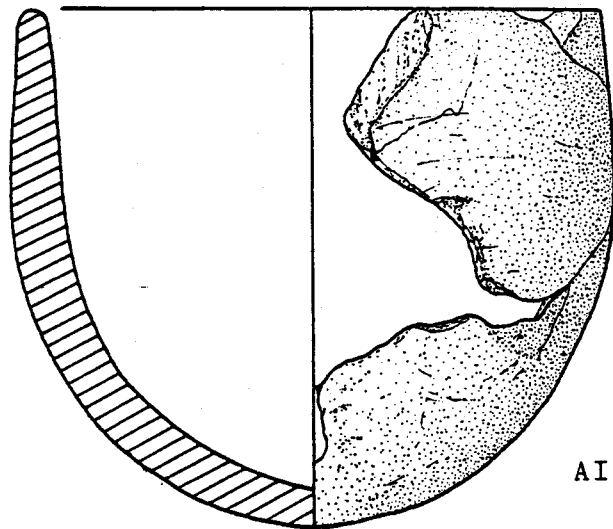

AI 5

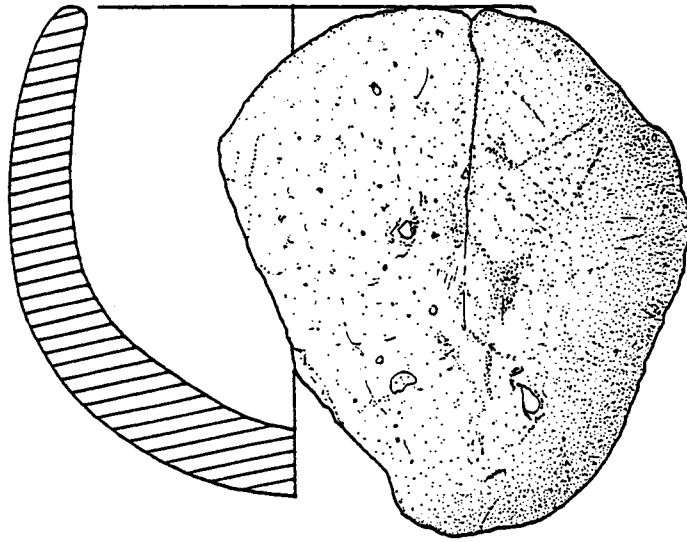

AI 20

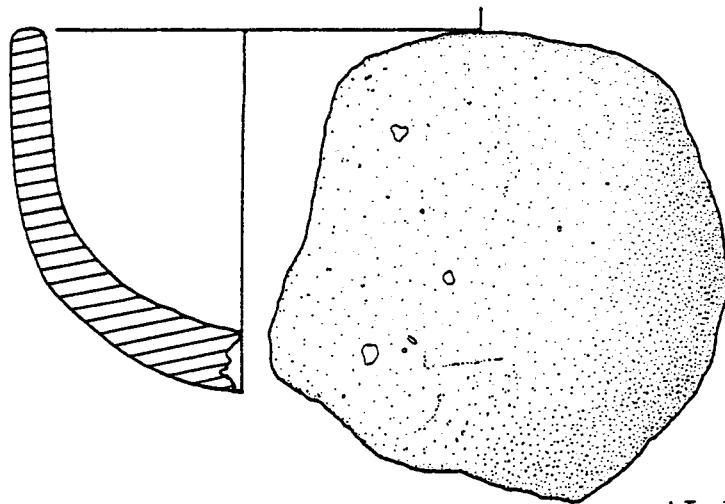

AI 15

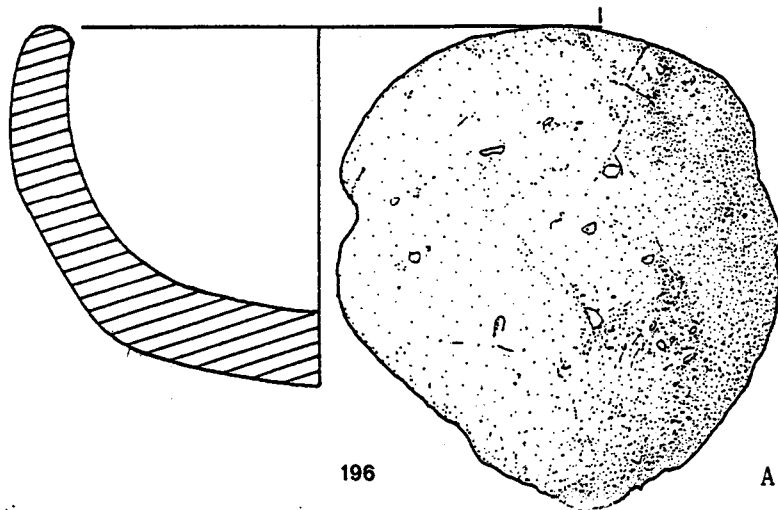

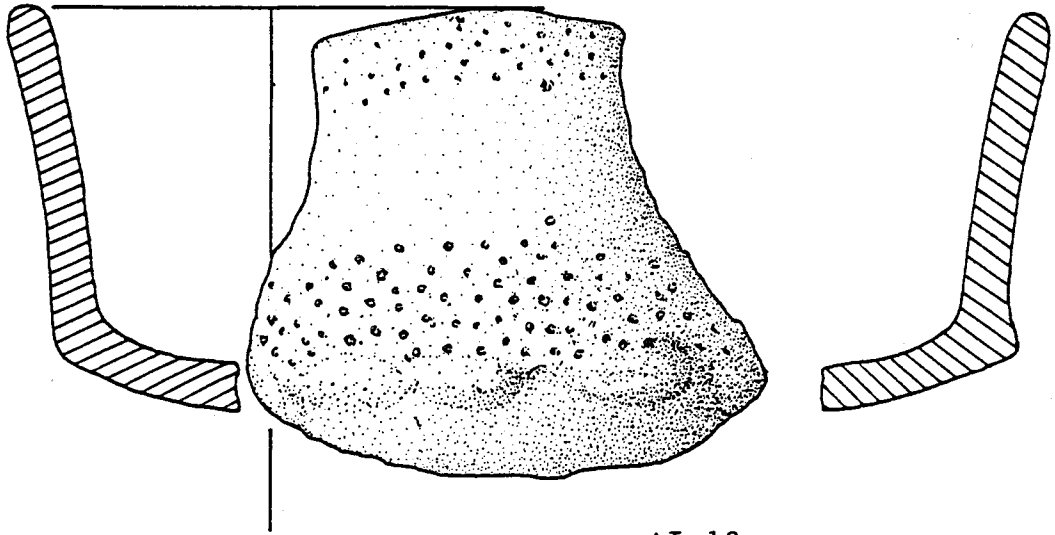

AI 13

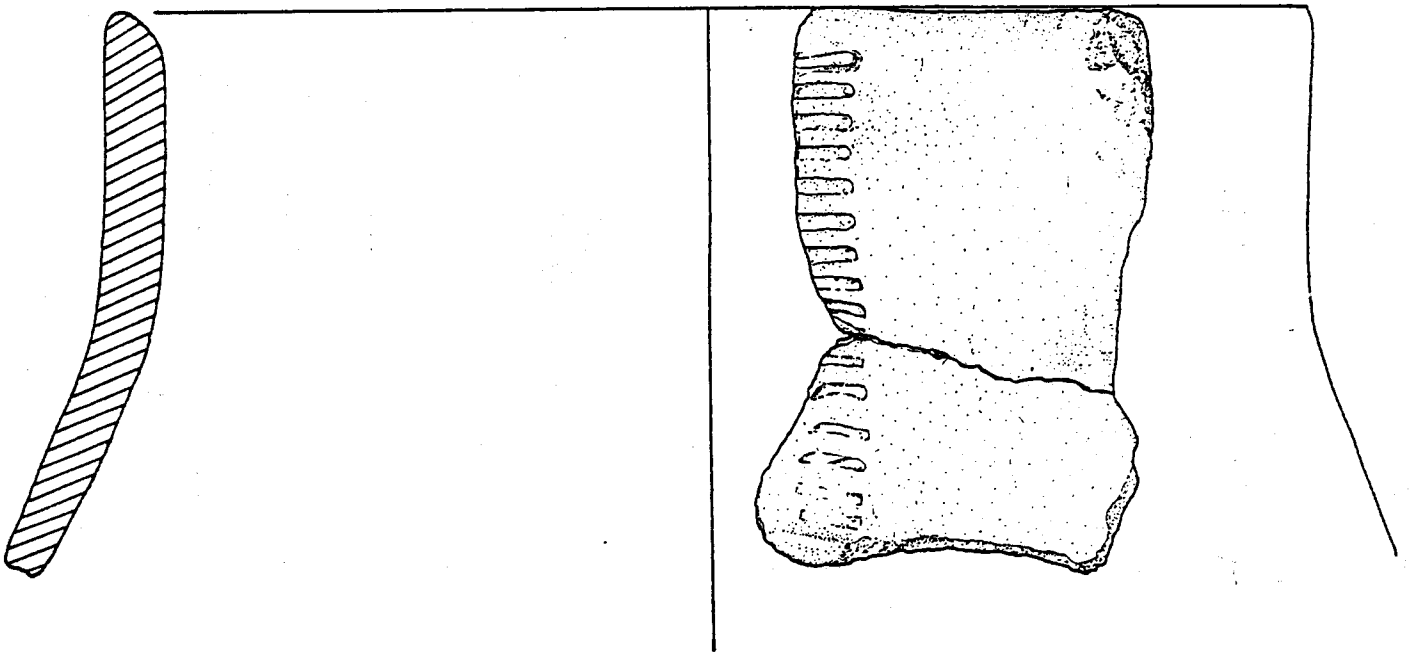

AI 8



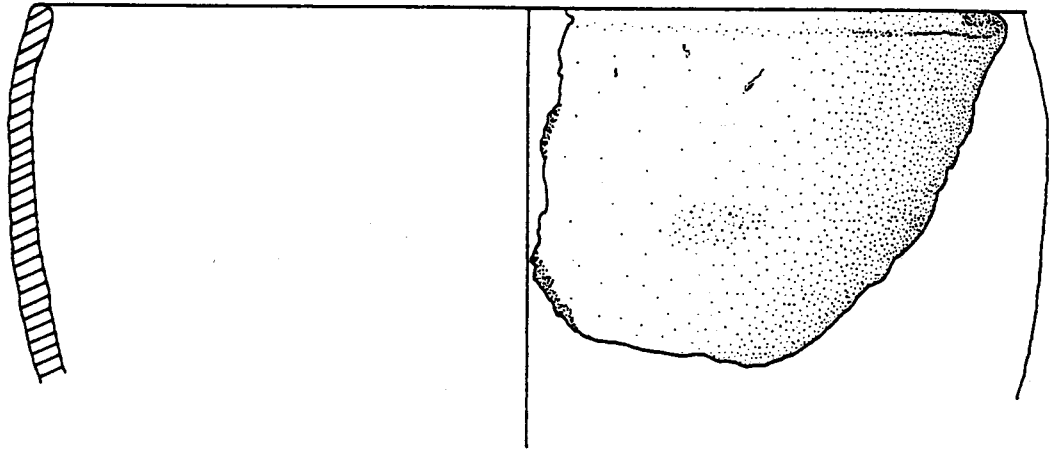

AI 25

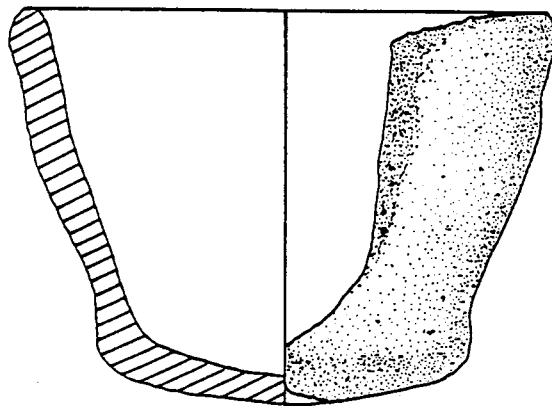

AI 19

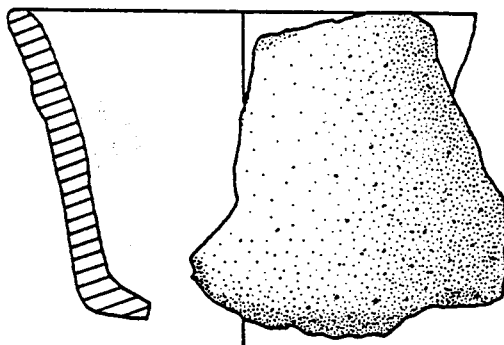

AI 21



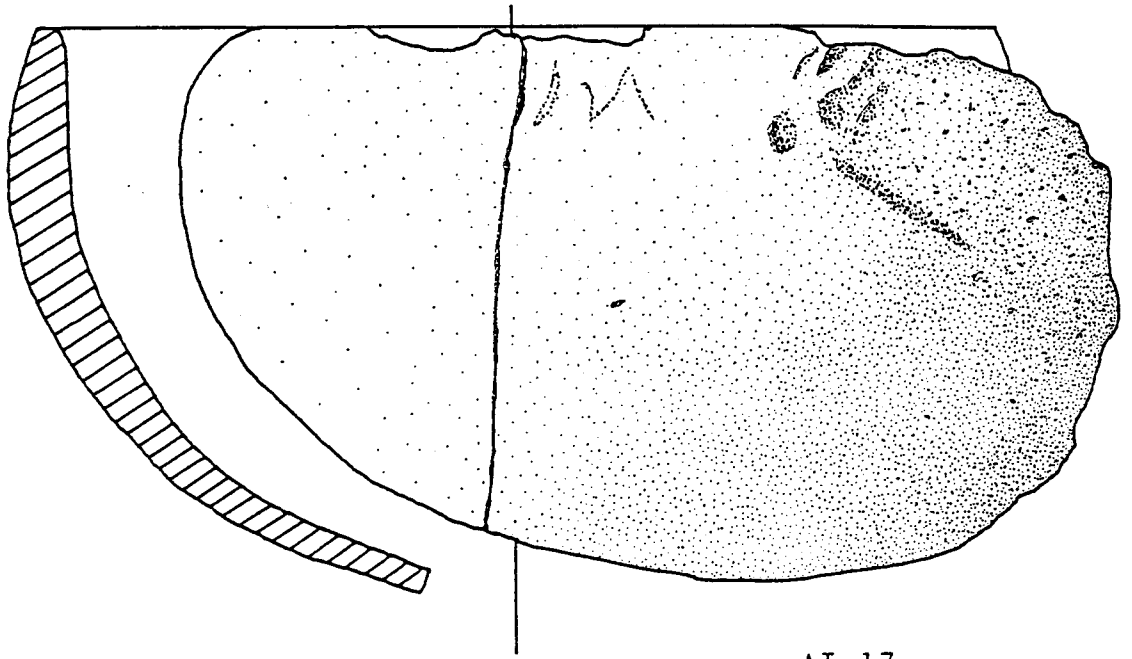

AI 17

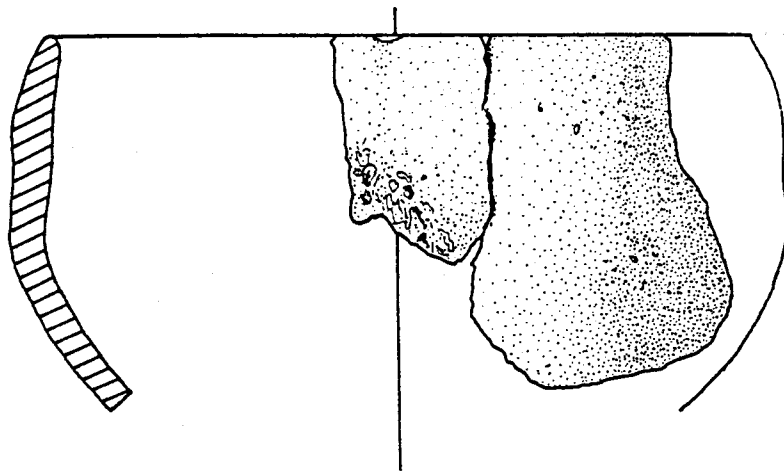

AI 26



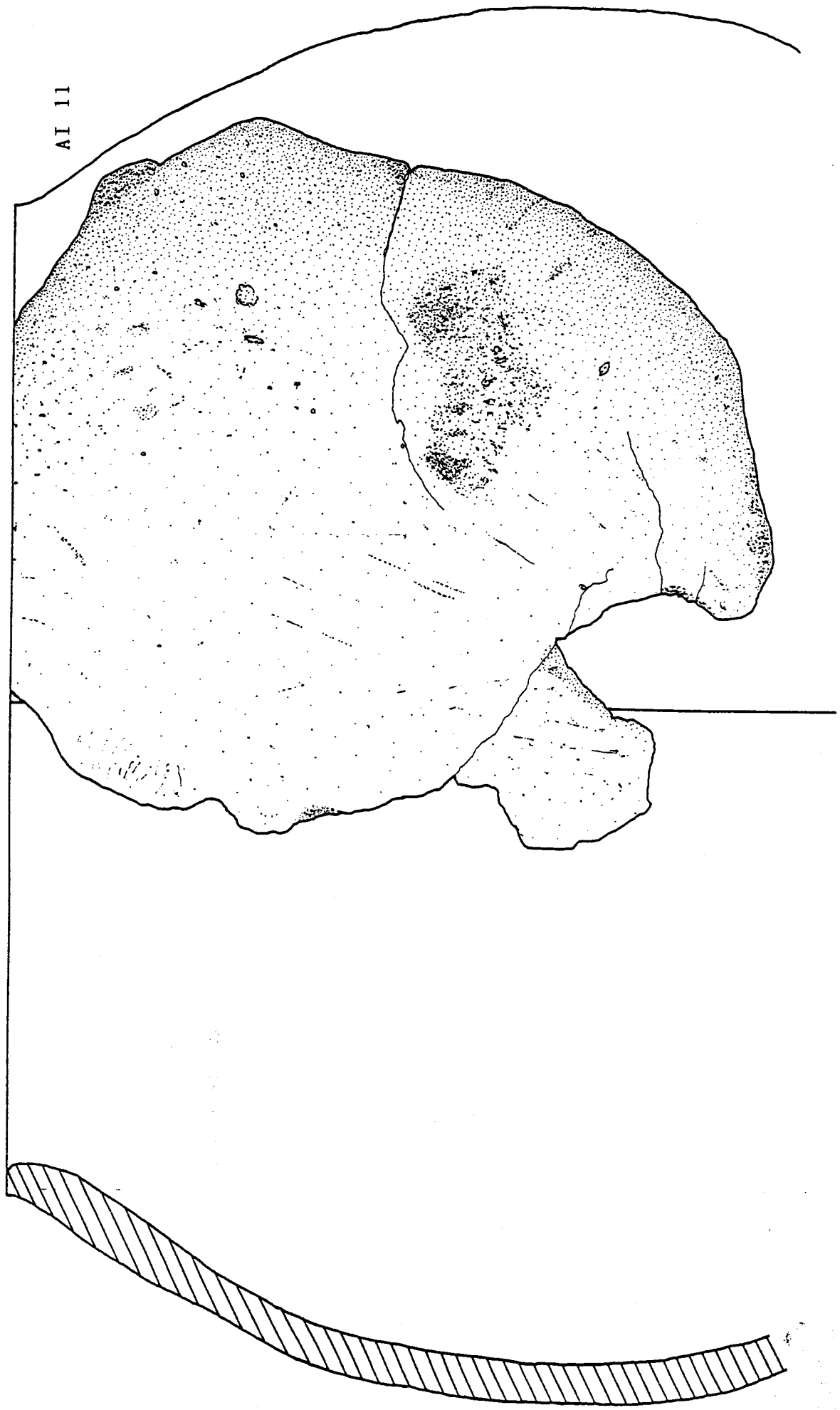

AI 11





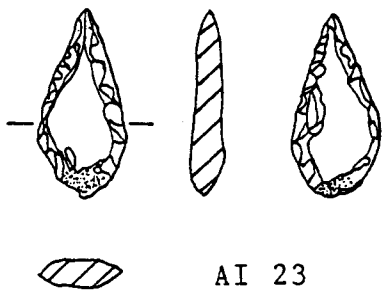

AI 23

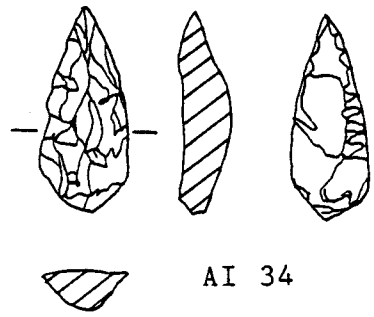

AI 34

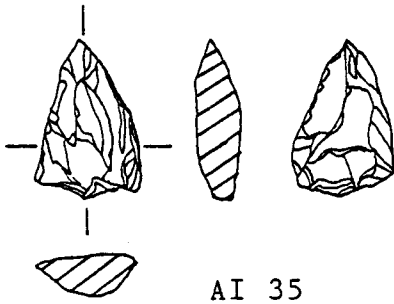

AI 35

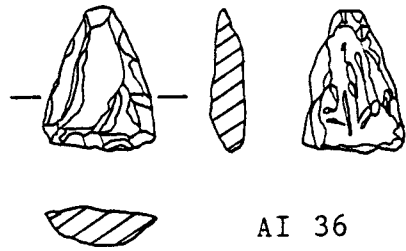

AI 36

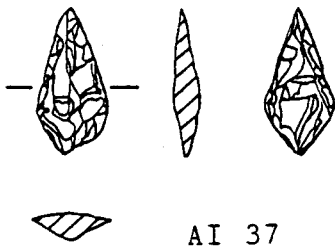

AI 37

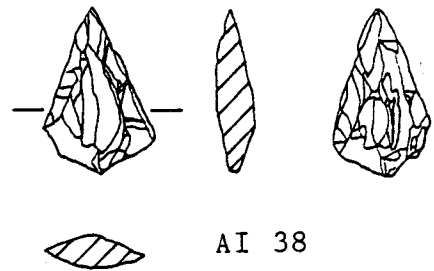

AI 38

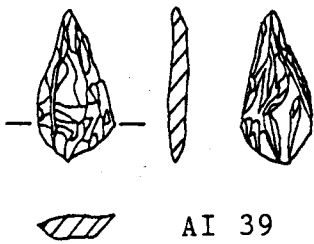

AI 39

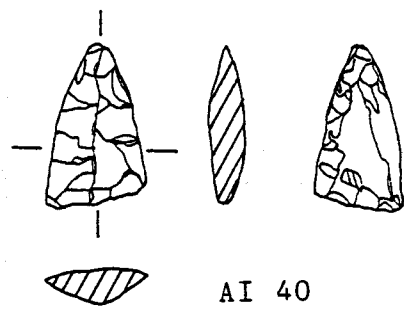

AI 40

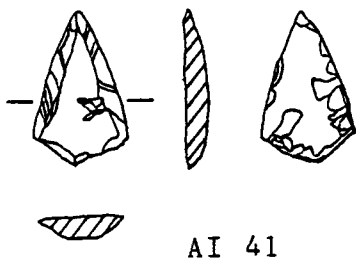

AI 41

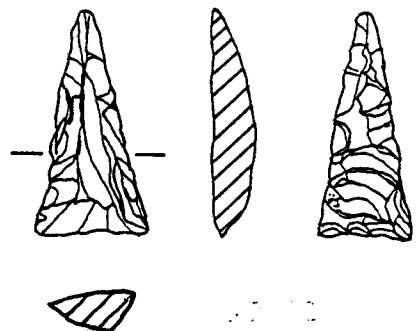

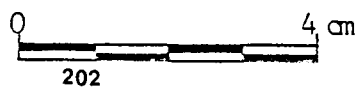
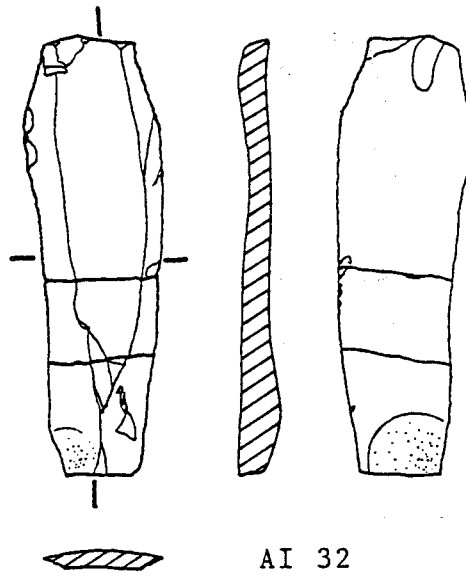
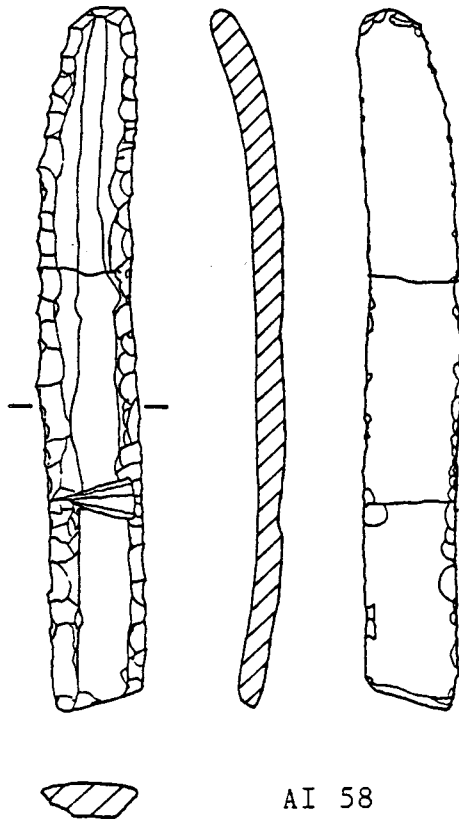

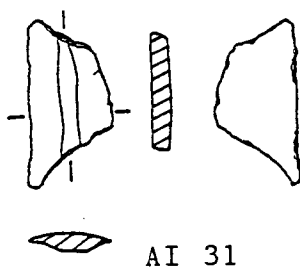
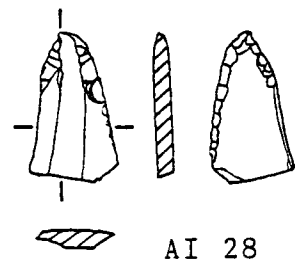
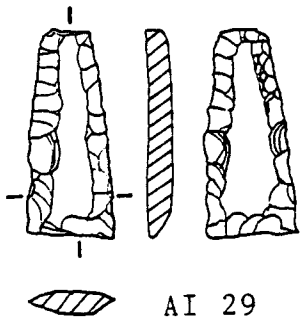
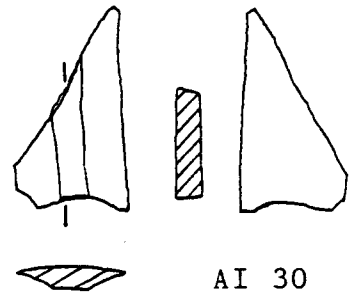
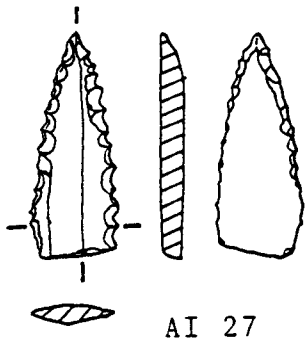

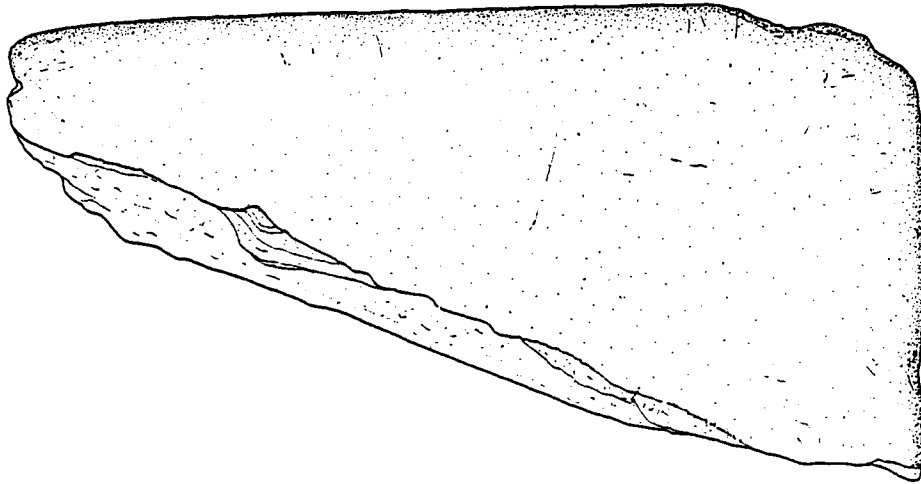

AI 53

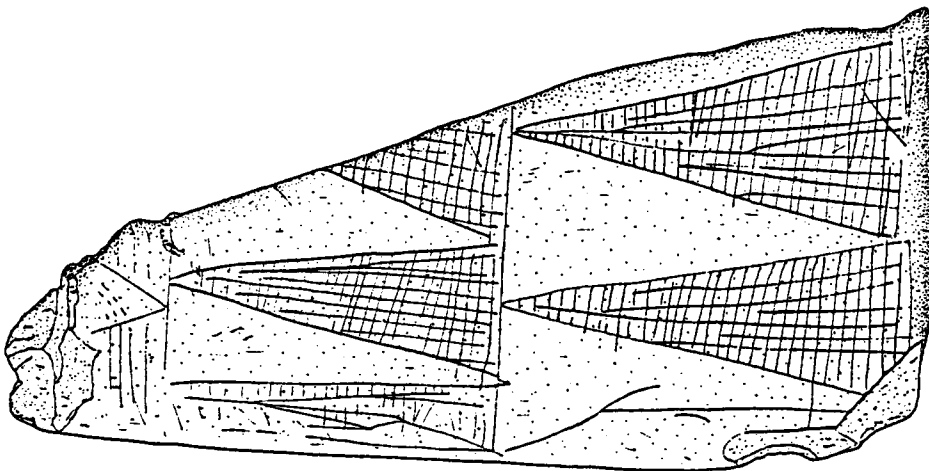

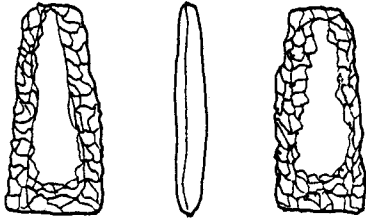

AI 43

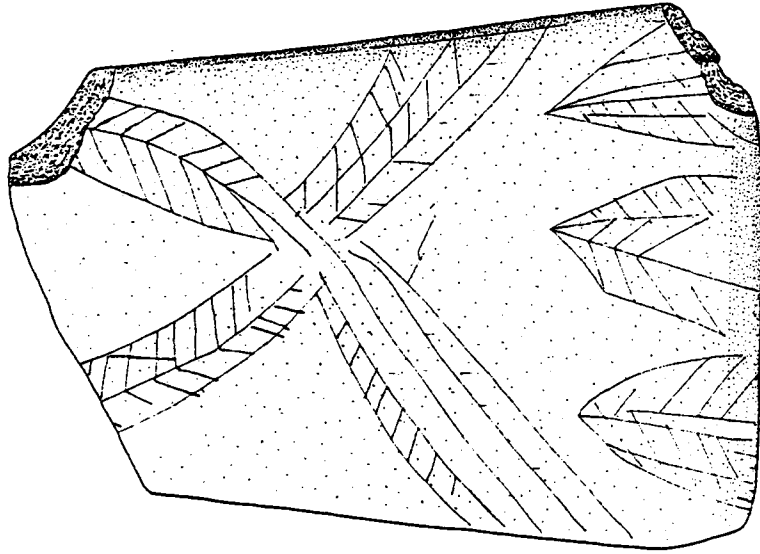

AI 54

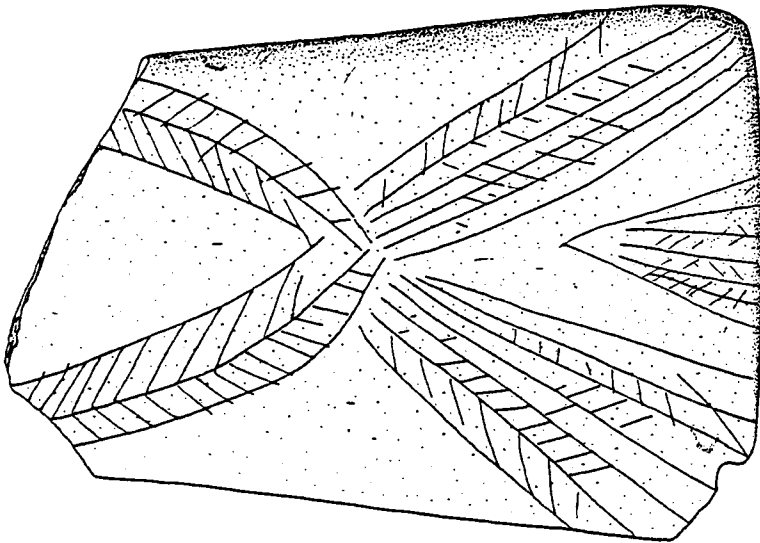

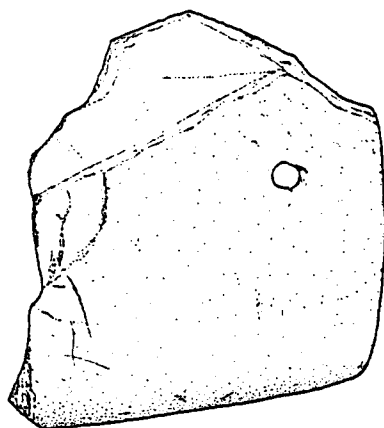
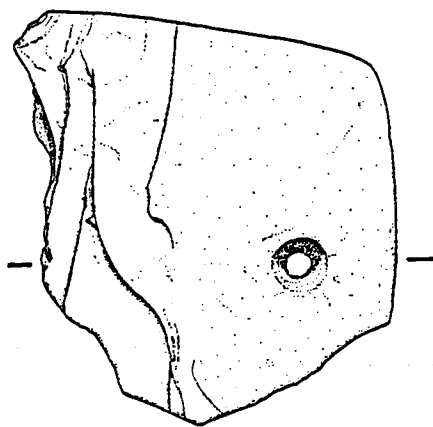

AI 56



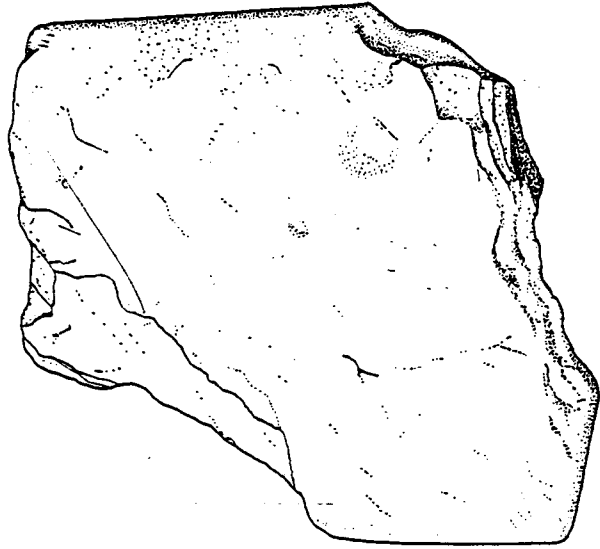

AI 55

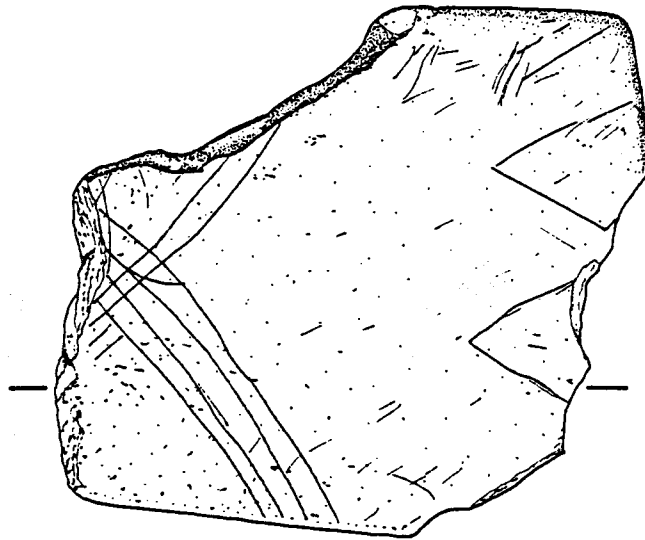





ANTA  
**II do ALCOGULO**



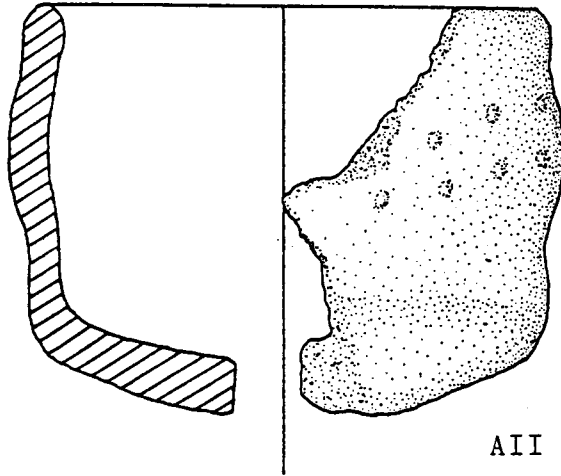

AII 4

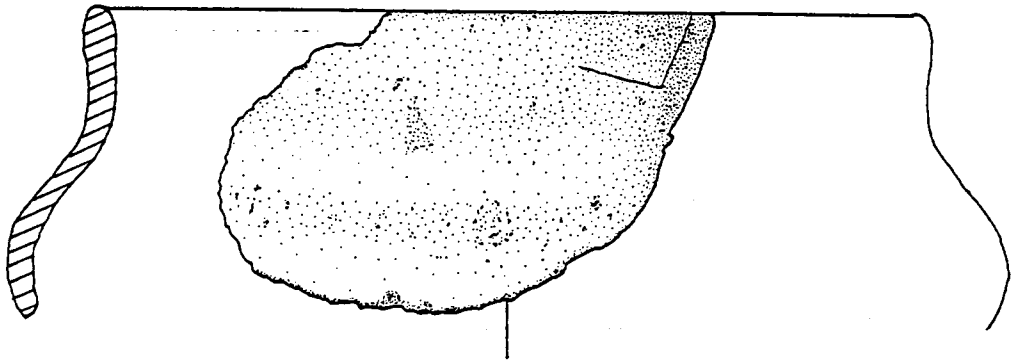

AII 86

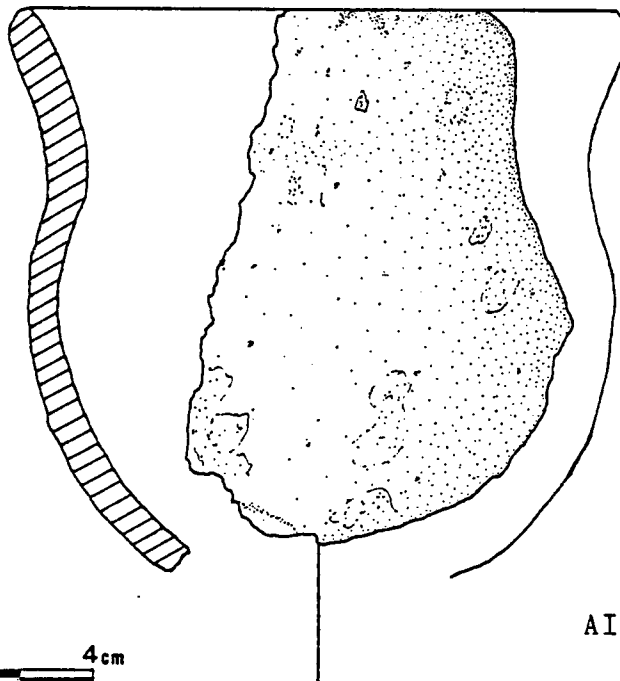

AII 80



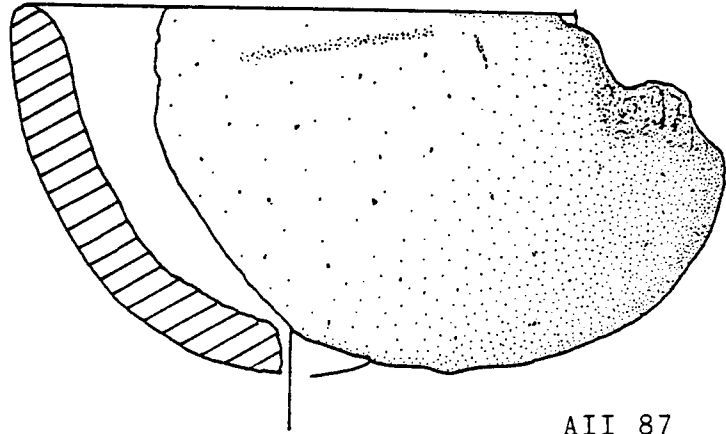

AII 87

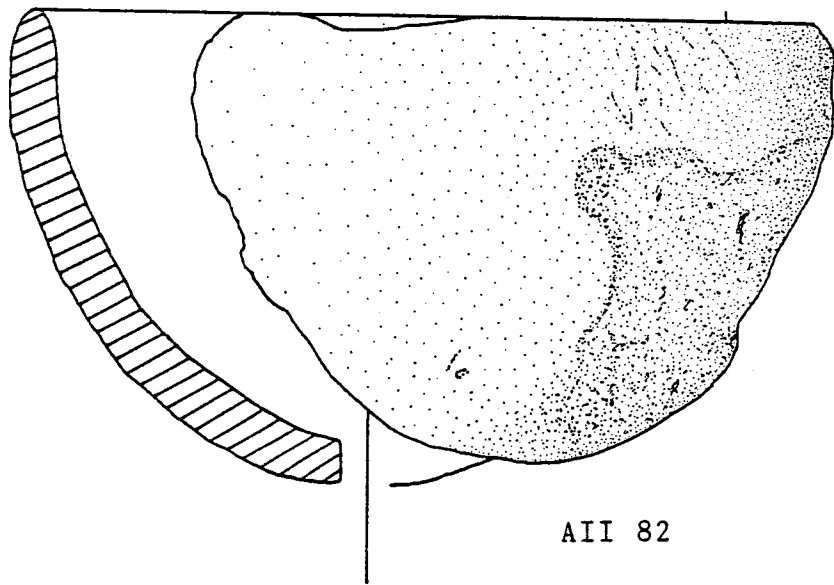

AII 82



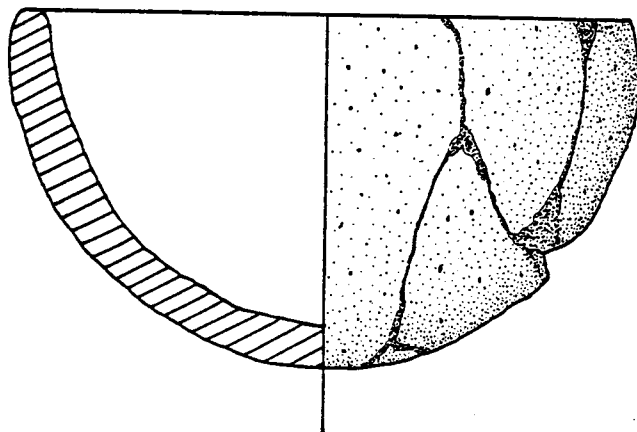

AII 2

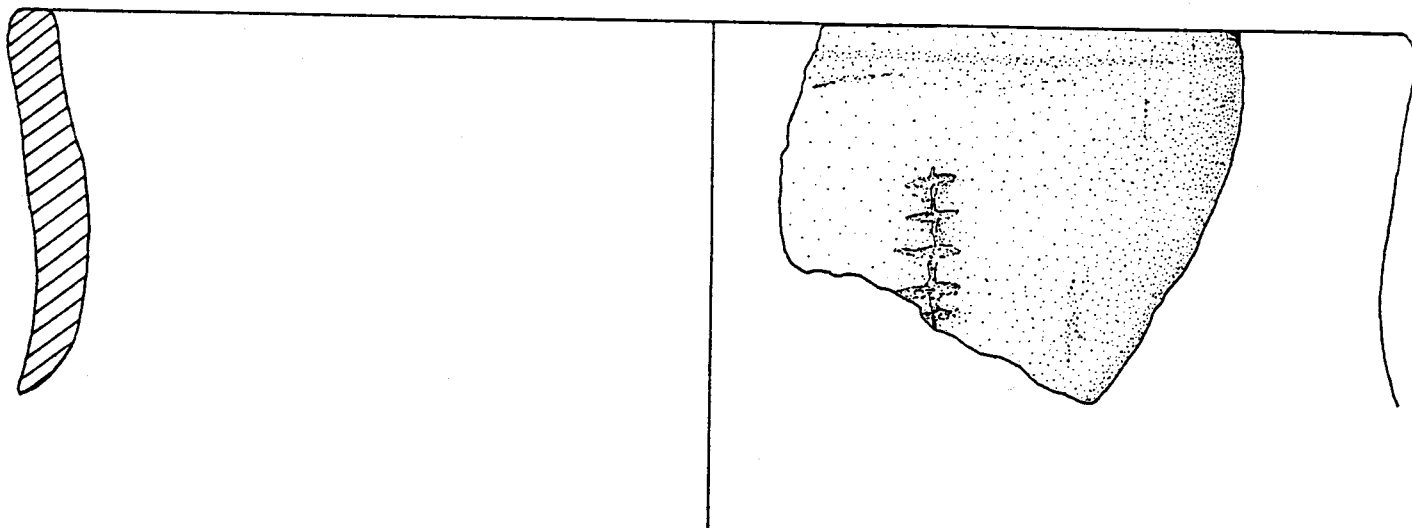

AII 83



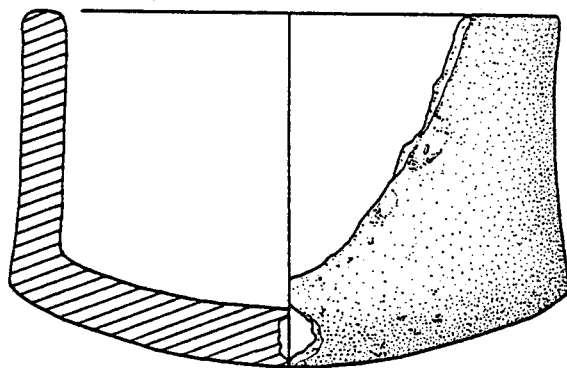
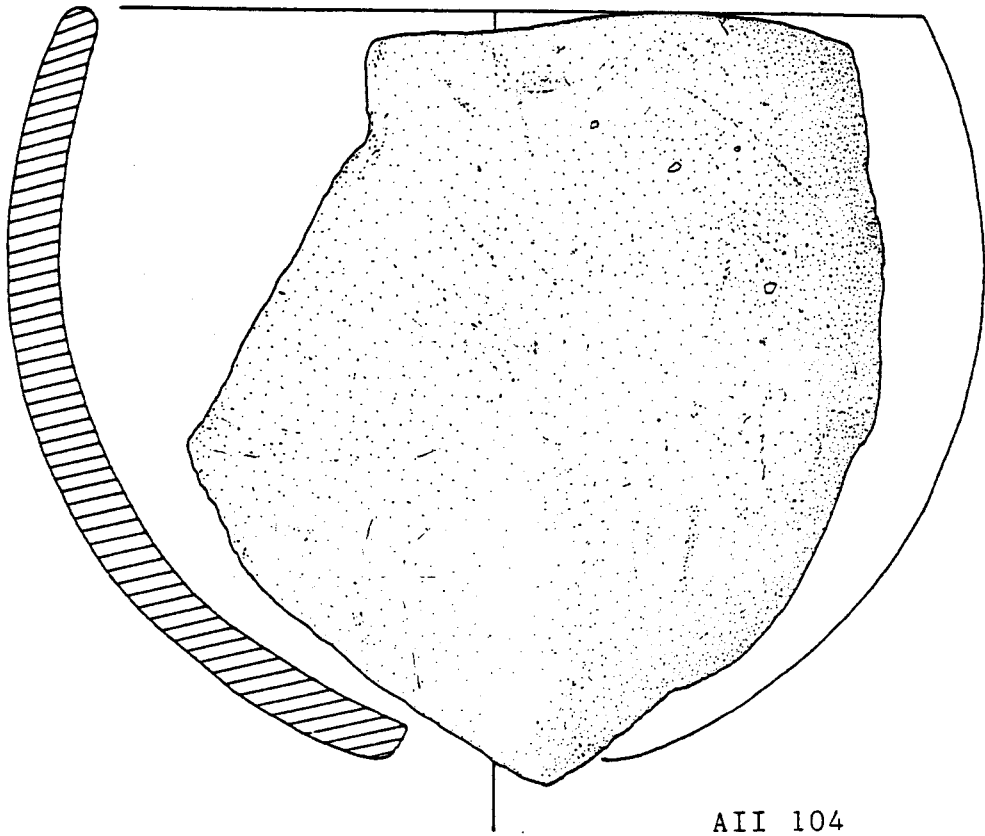

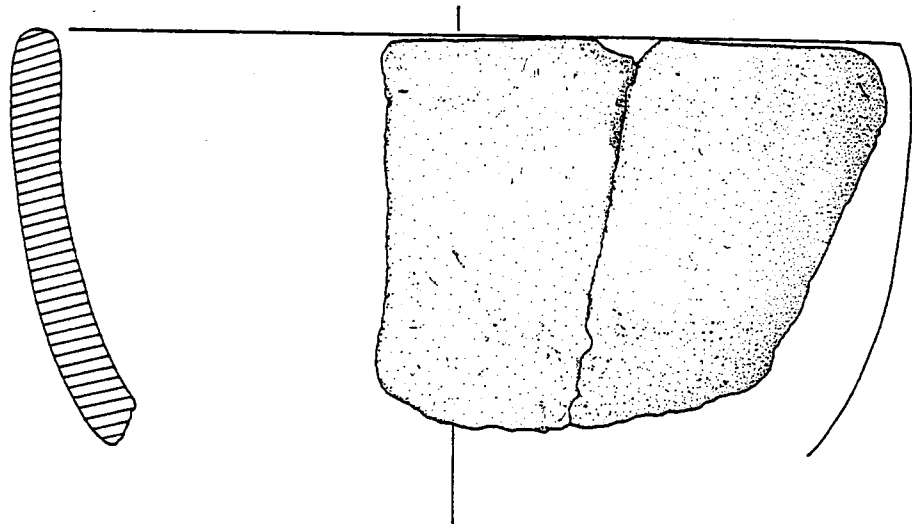

AII 111

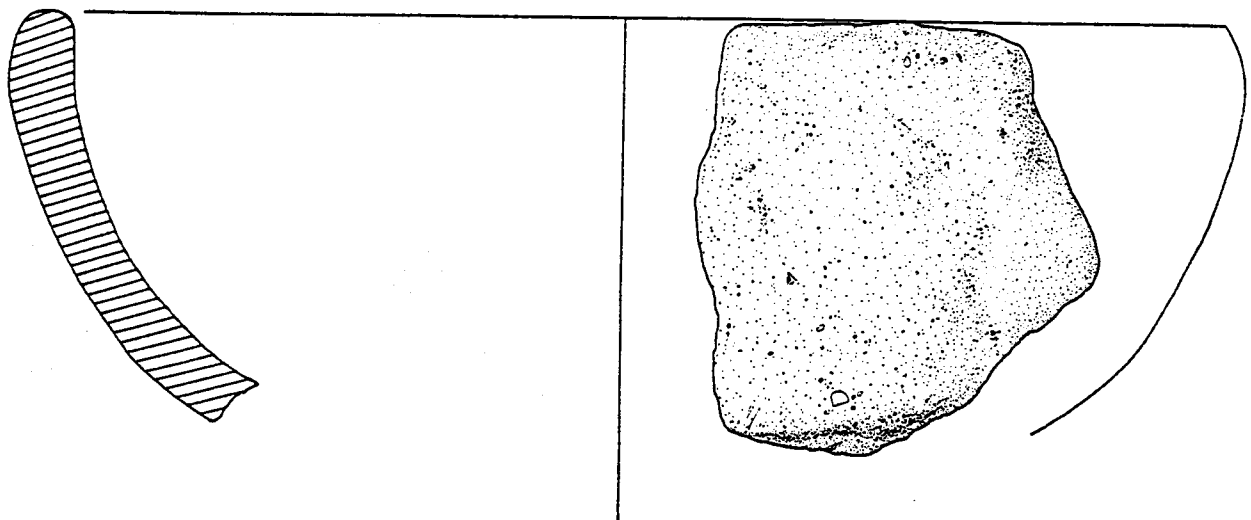

AII 79





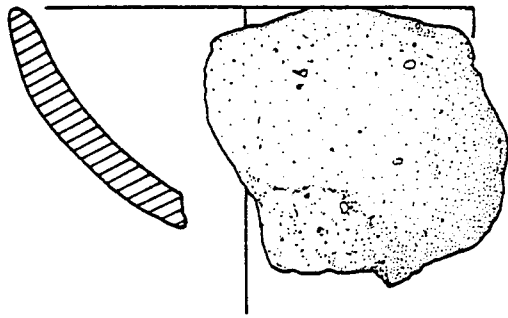

AII 97

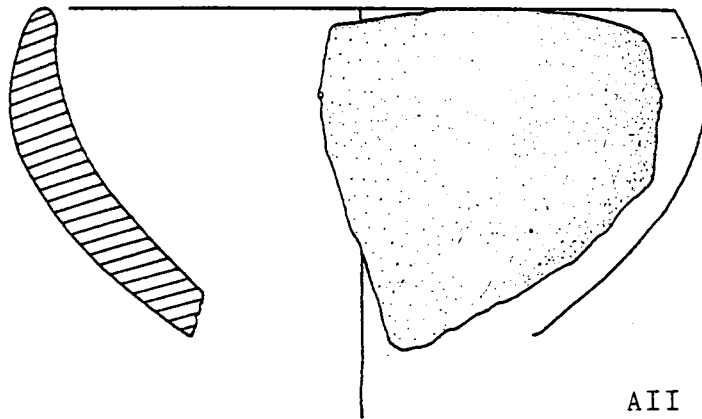

AII 98

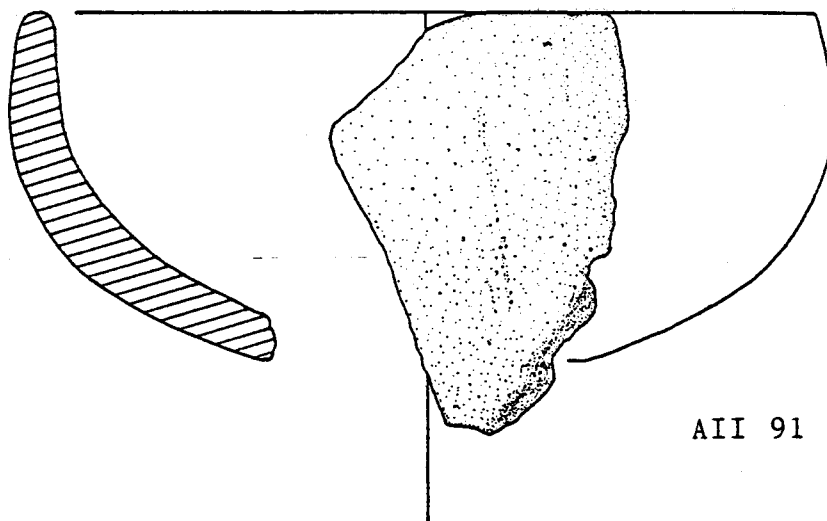

AII 91

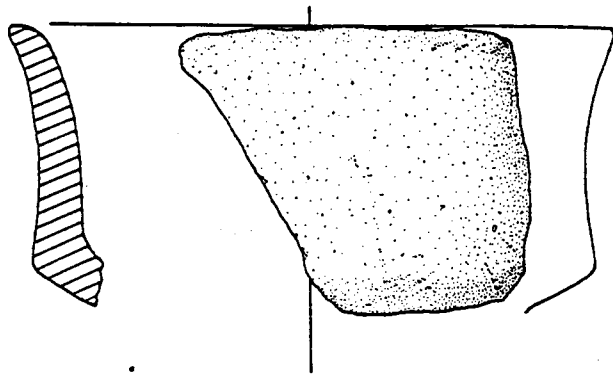

AII 110

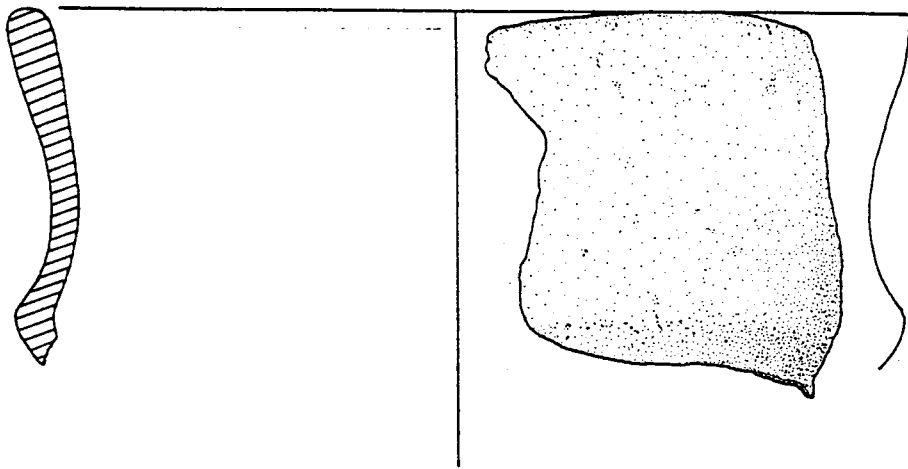

AII 85

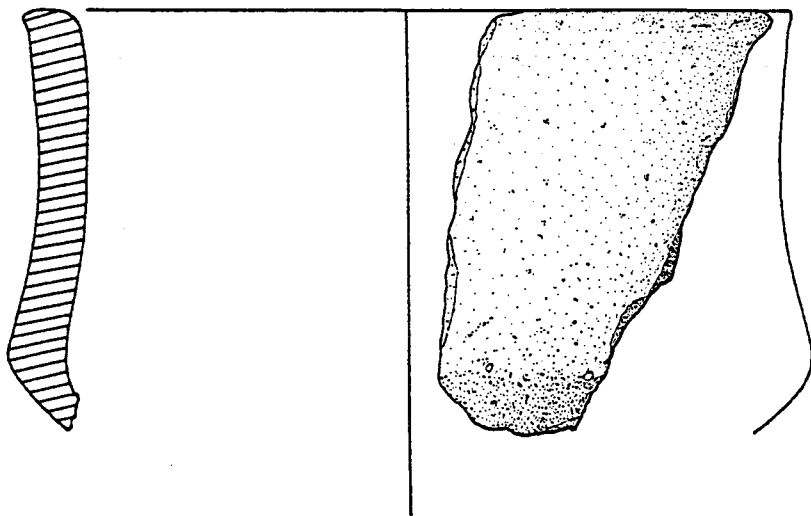

AII 88

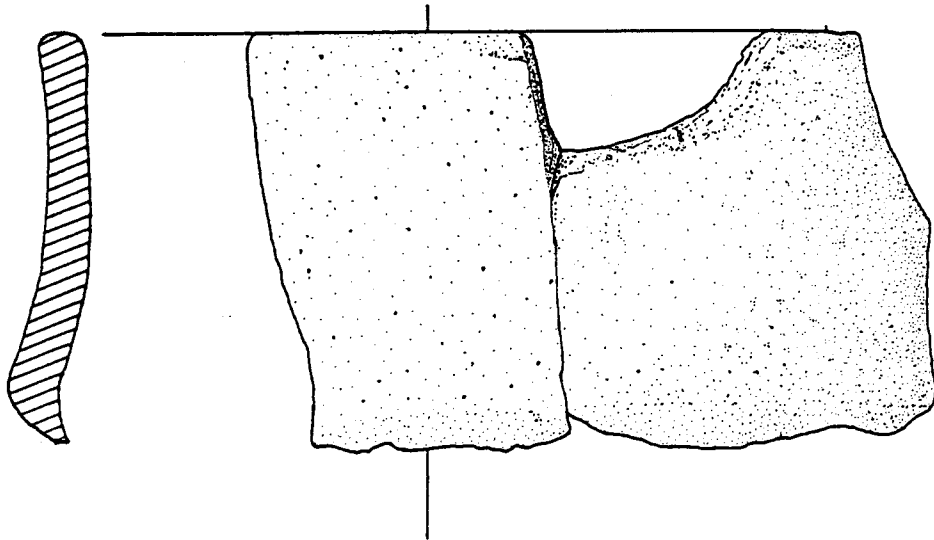

AII 103

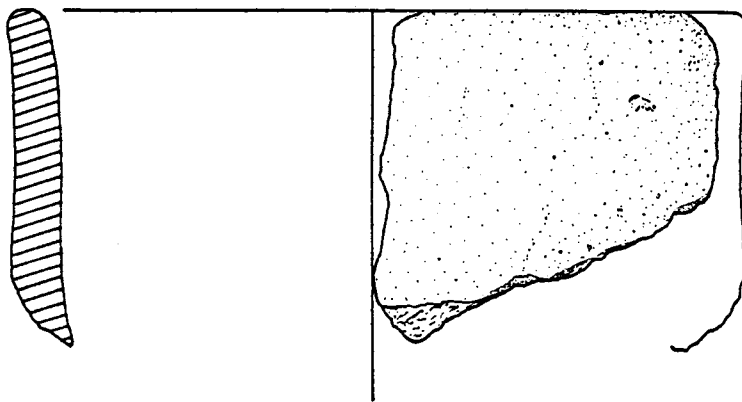

AII 109

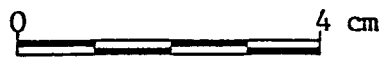

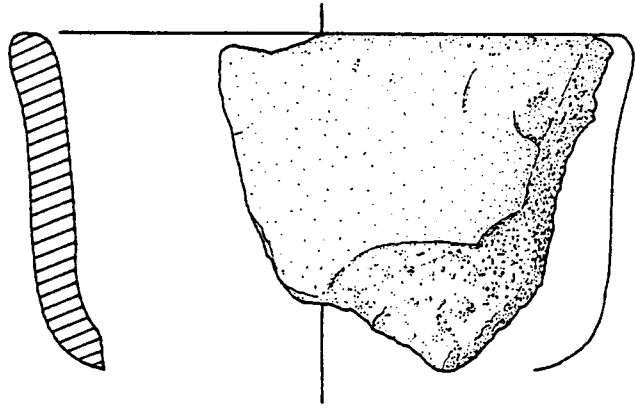

AII 108

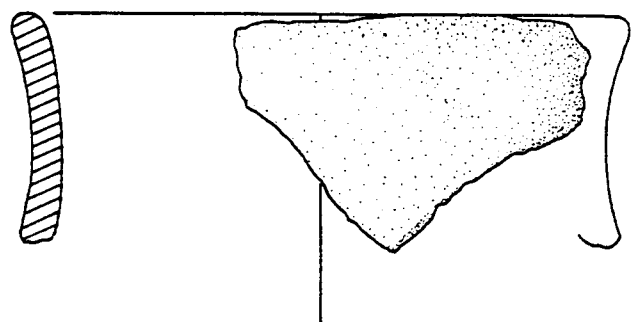

AII 100

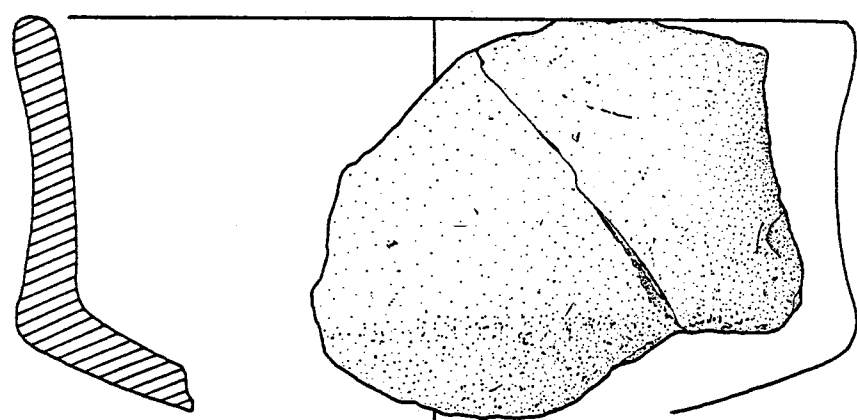

AII 108 a



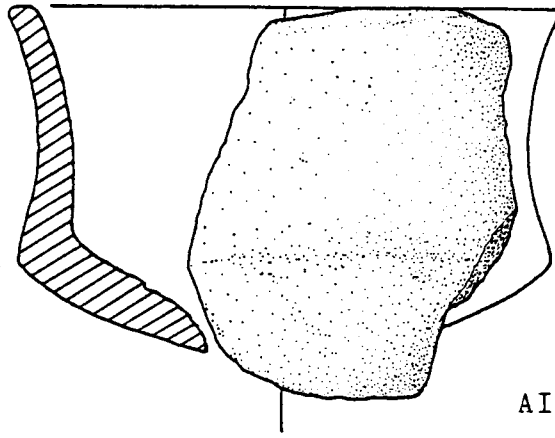

AII 94

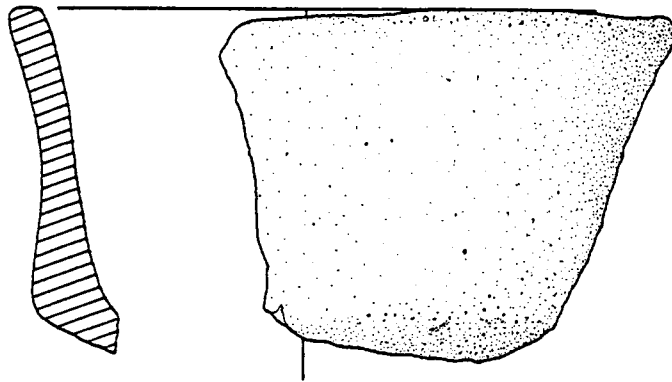

AII 90

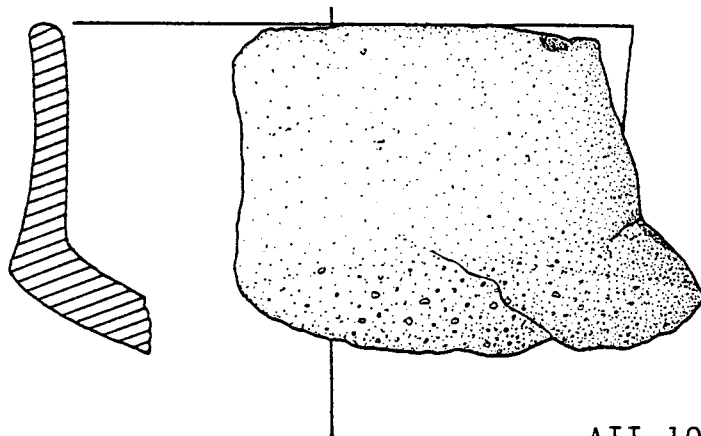

AII 105



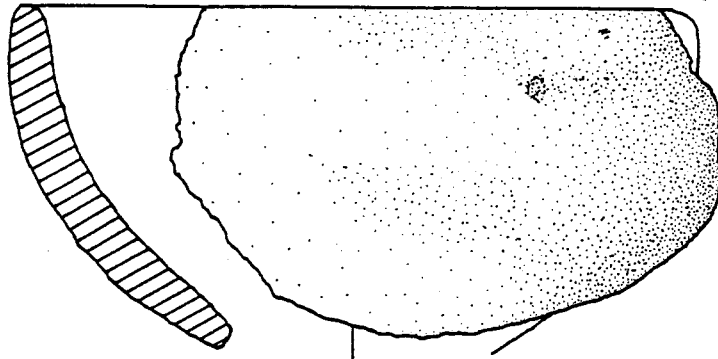

AII 81

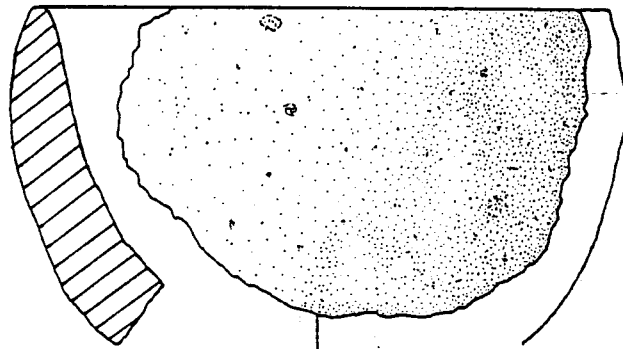

AII 101

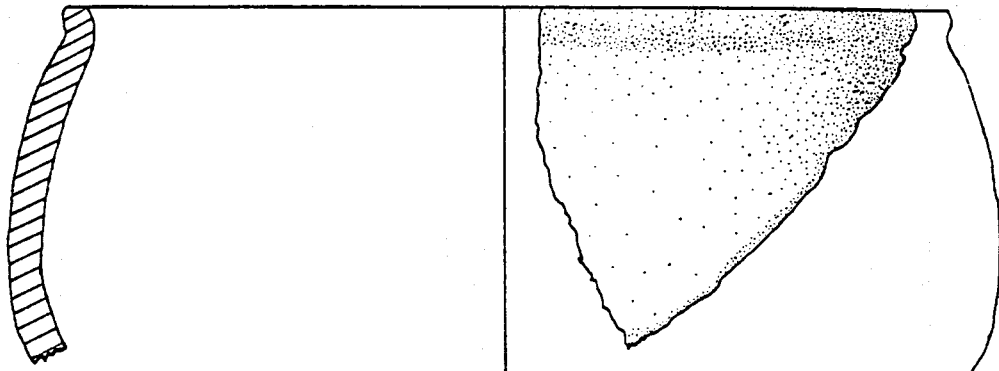

AII 89



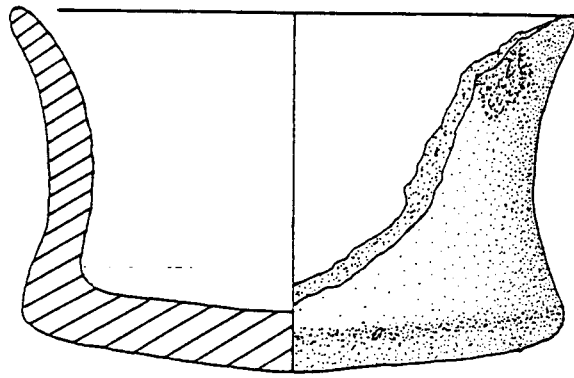

AII 3





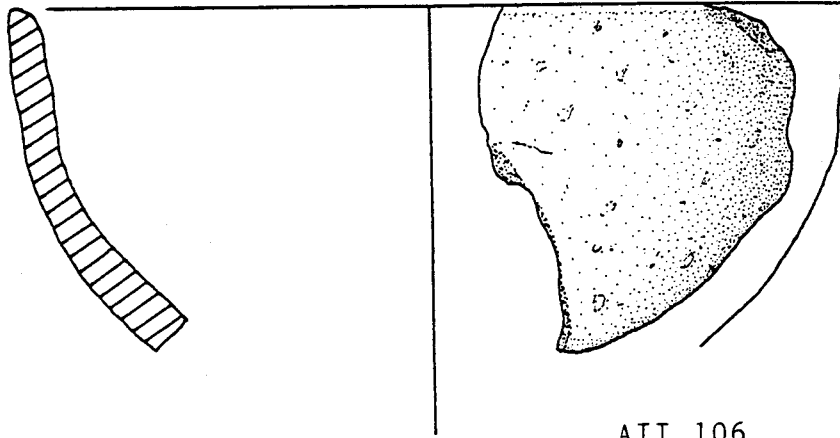

AII 106

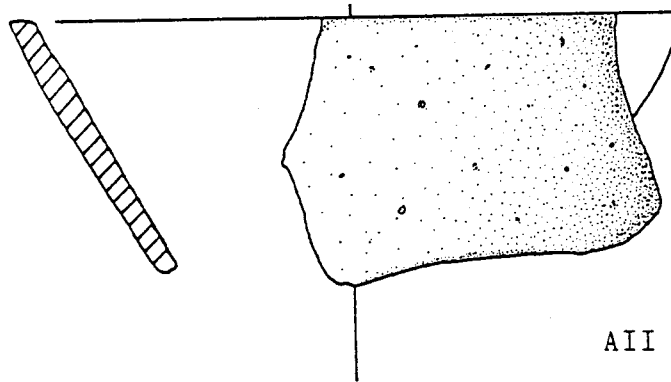

AII 96

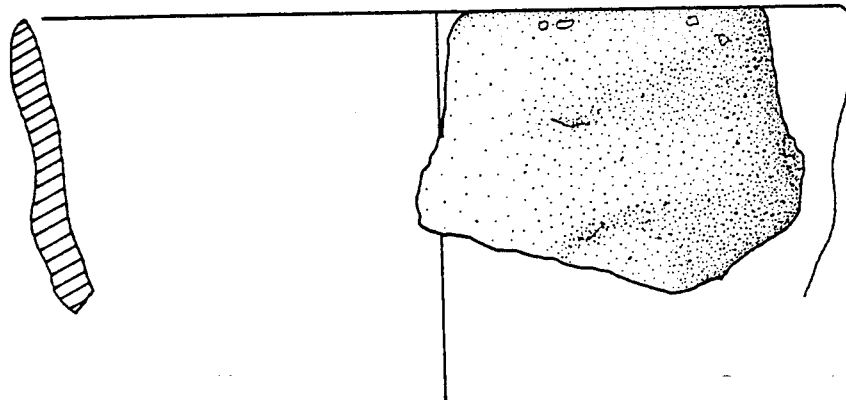

AII 95



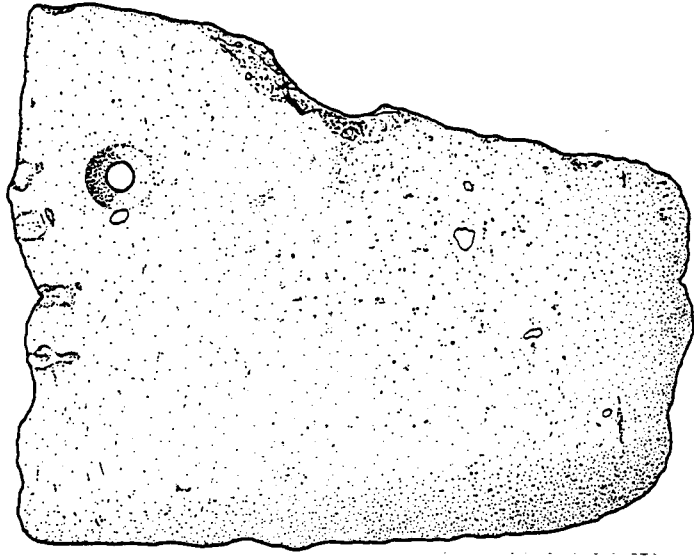
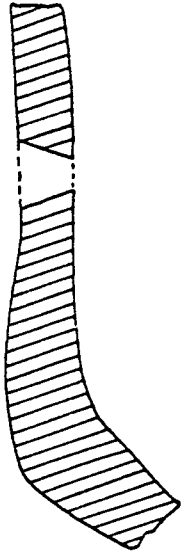

AII 93

*J.F.A. Mac...*

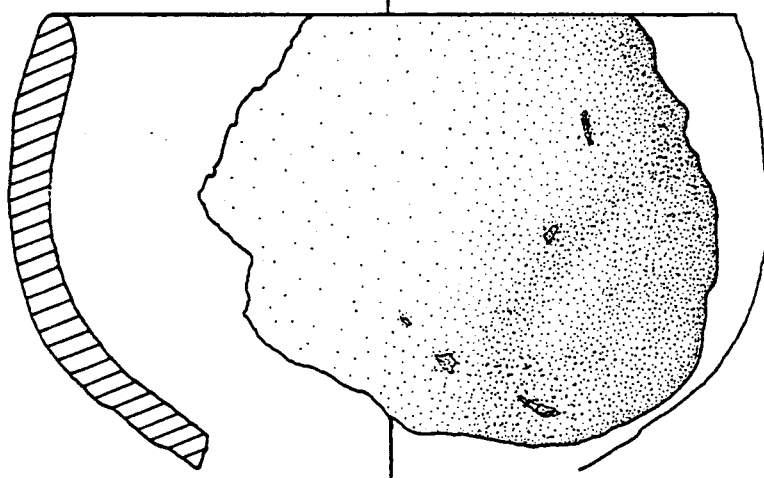

AII 107



AII 99



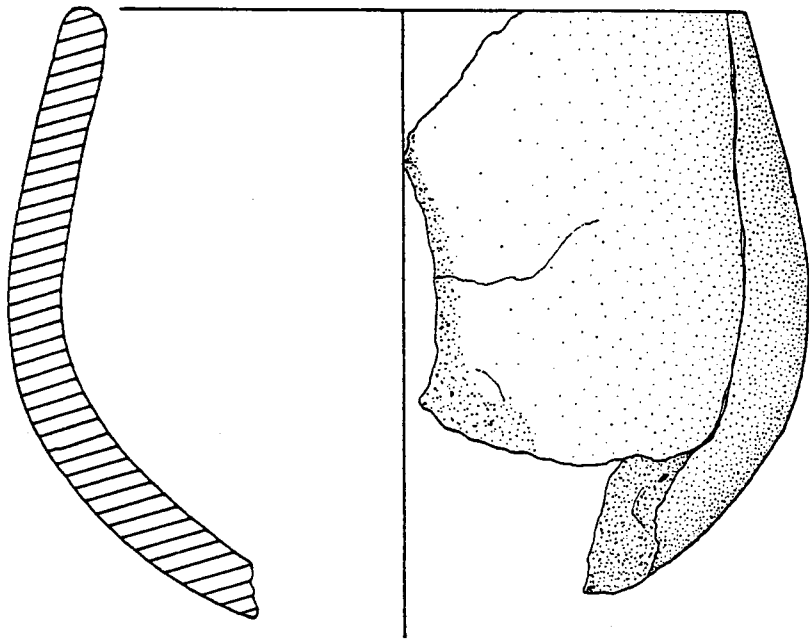

AII 102

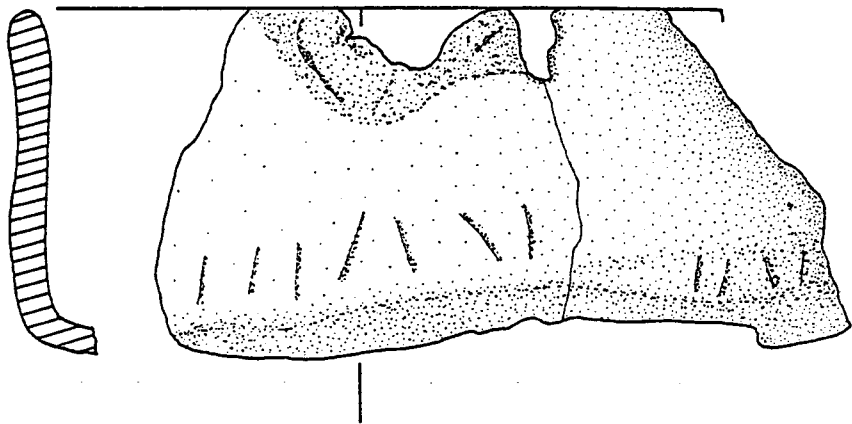

AII 112



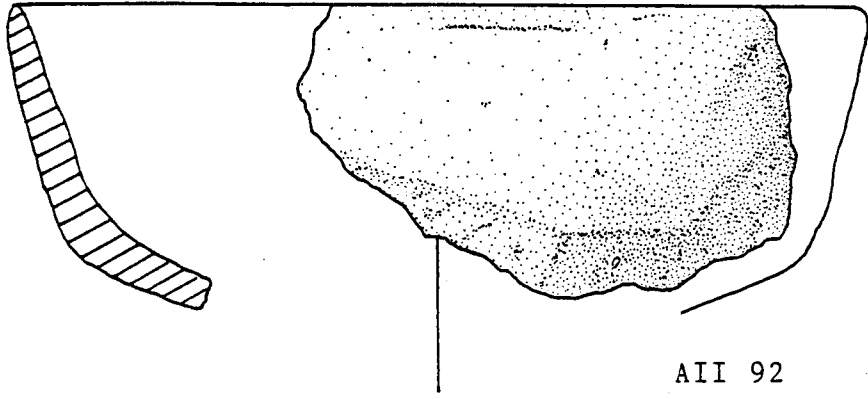

AII 92

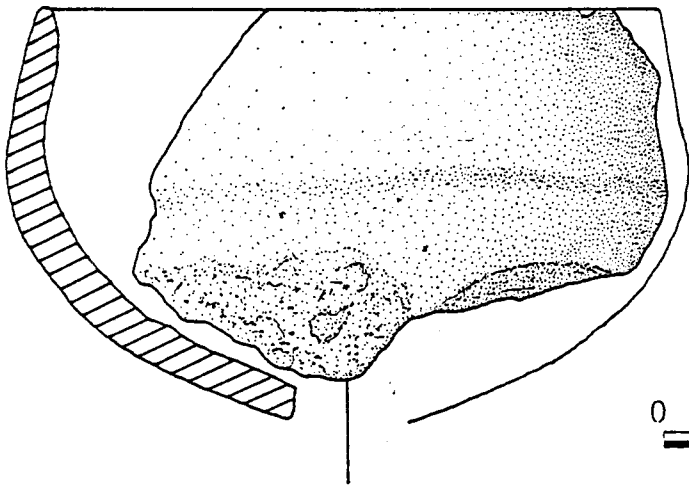

AII 83

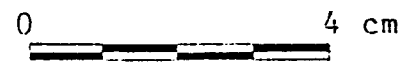

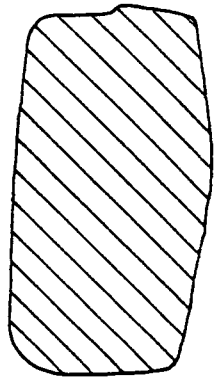
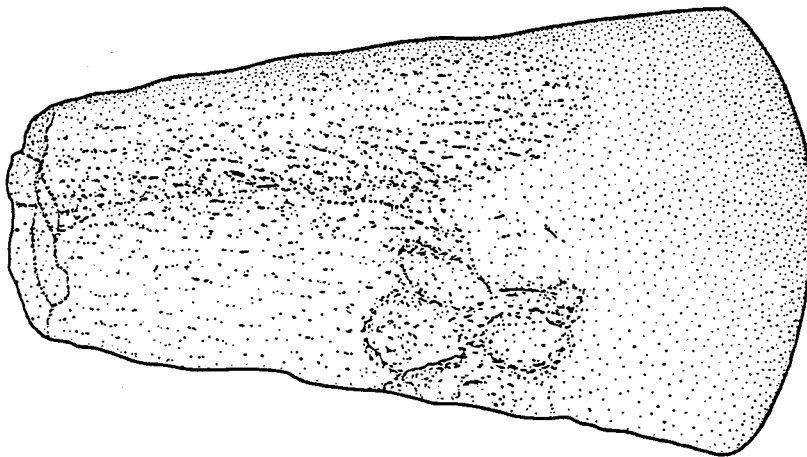
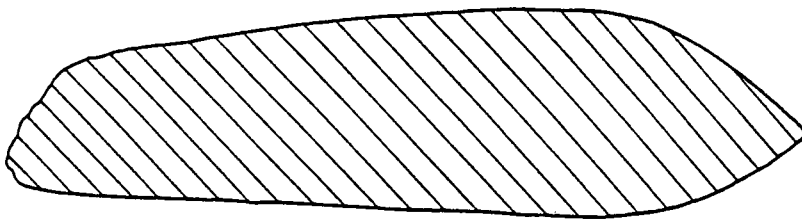
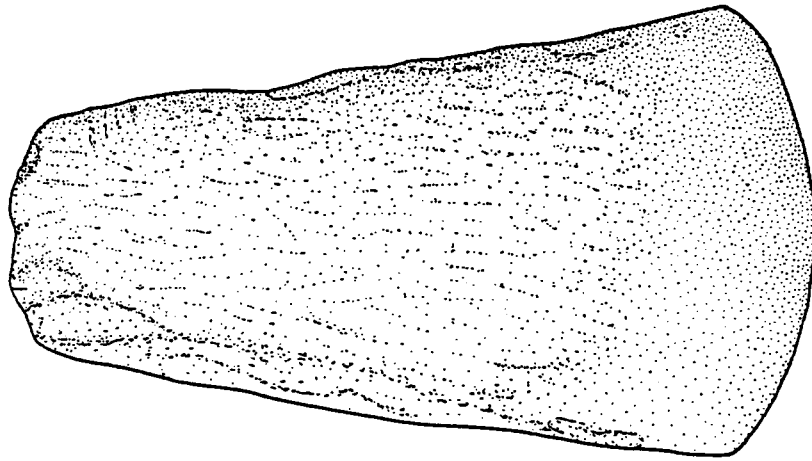

III 6



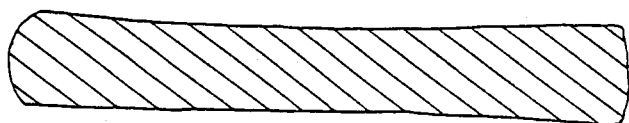
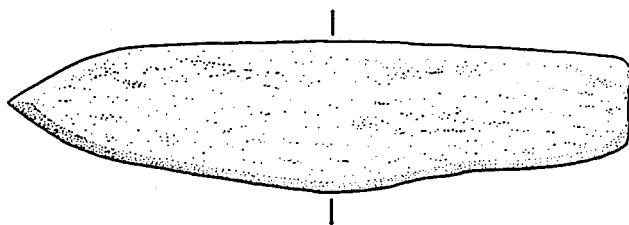
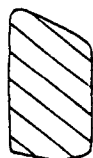

6 IIV



AII 5

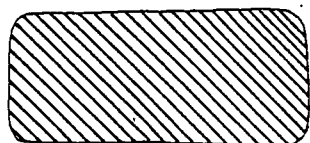
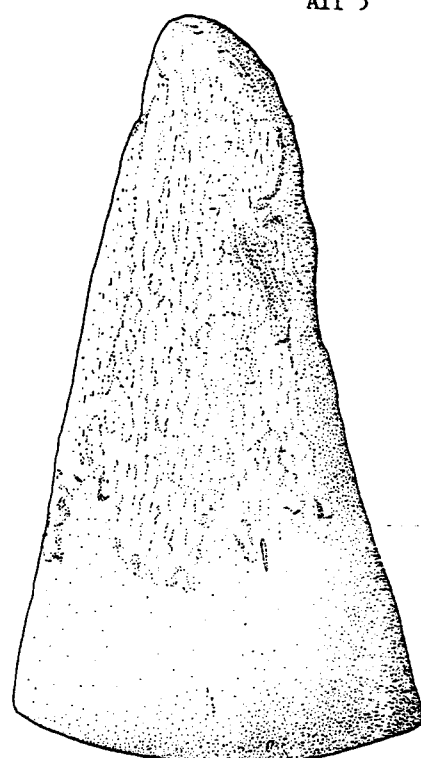
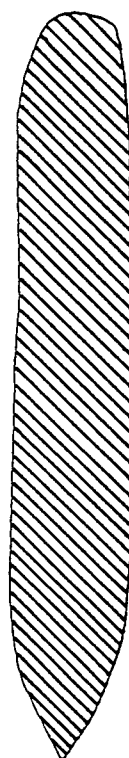
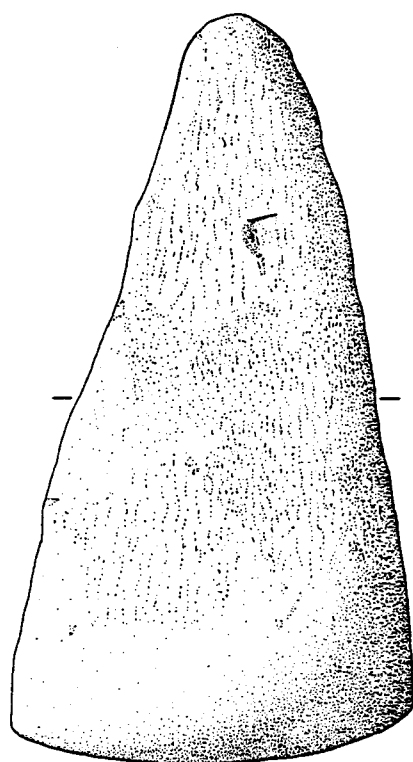



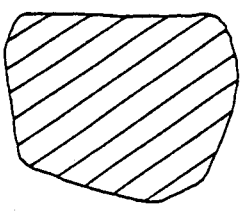
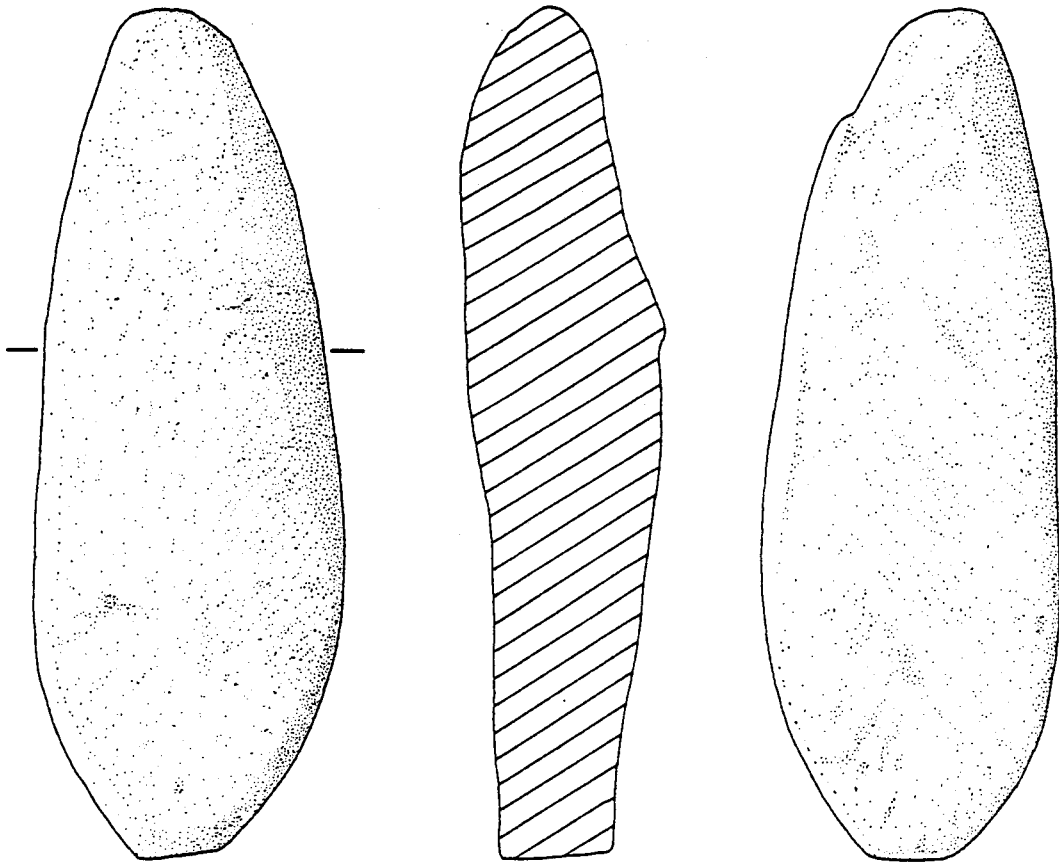

AII 7



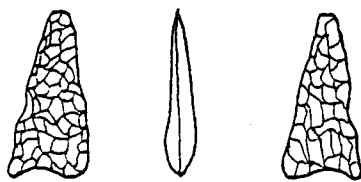

AII 28

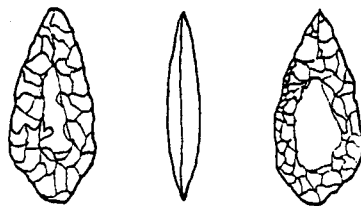

AII 23

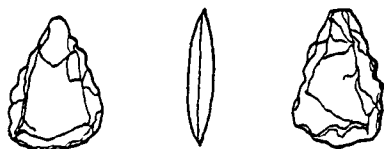

AII .36

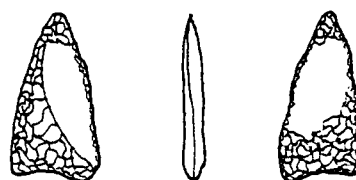

AII 57

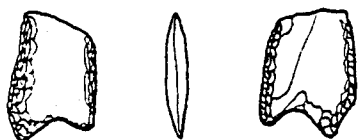

AII 20

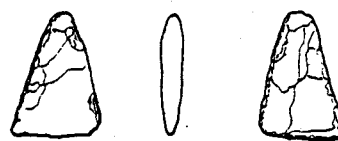

AII 62

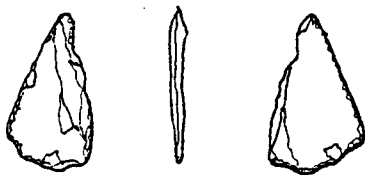

AII 61



AII 59



AII 25



AII 36



AII 24



AII 58



AII 32



AII 35



AII 29

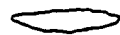

AII 26

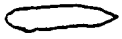
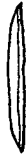

AII 60



AII 50

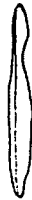

AII 47



AII 41

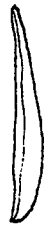

AII 17

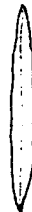
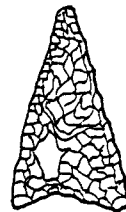

AII 33



AII 52

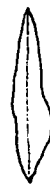

AII 39

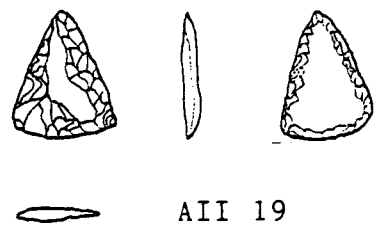
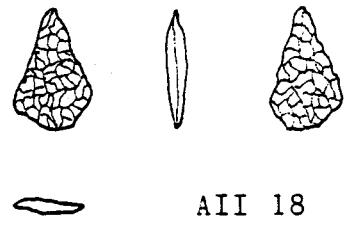
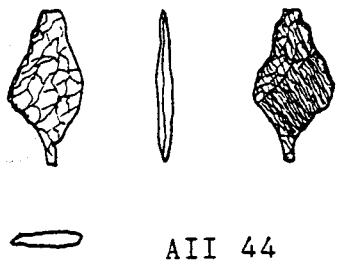
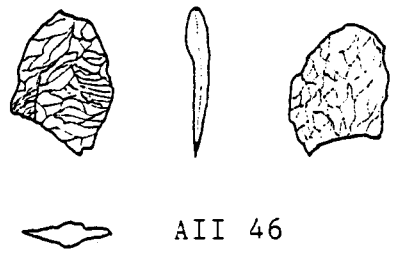
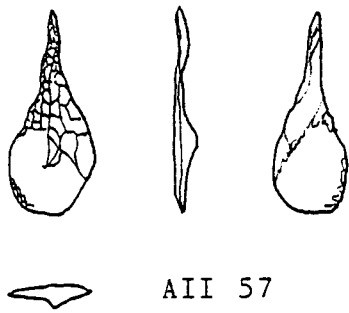
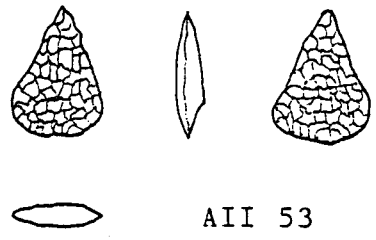
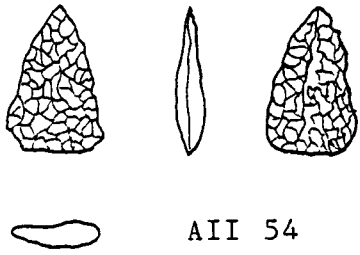

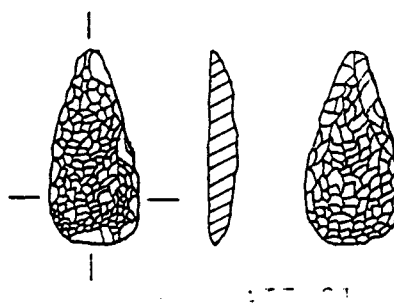
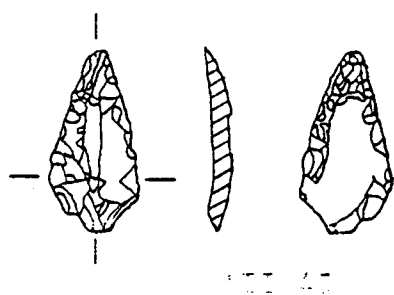
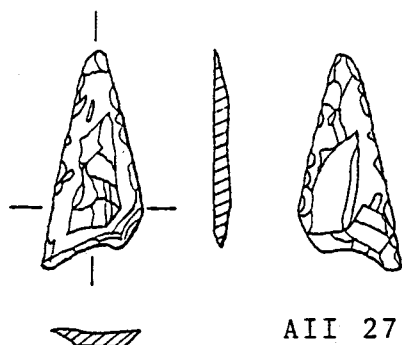
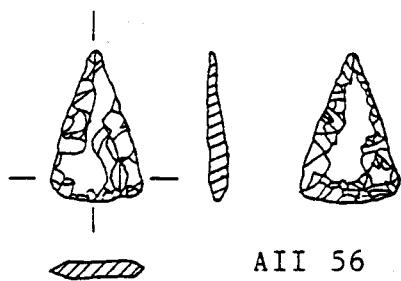
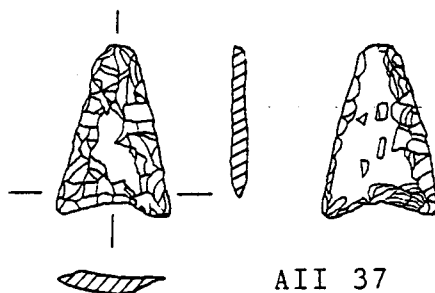
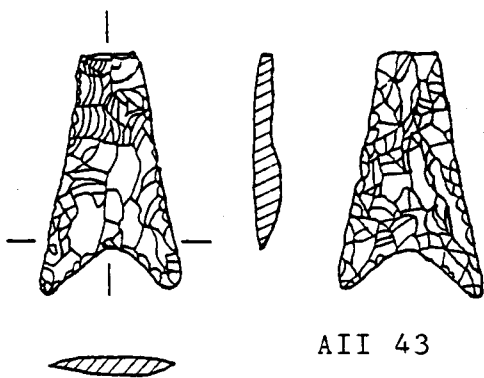
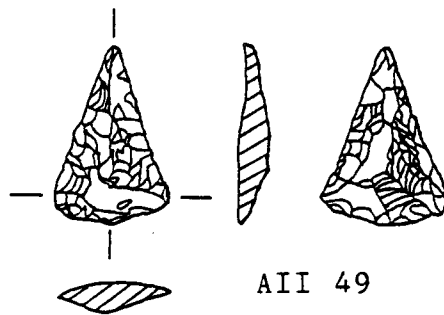
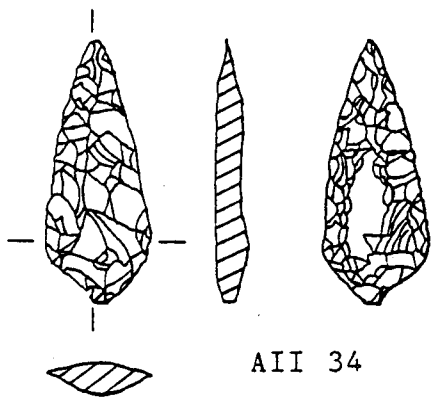

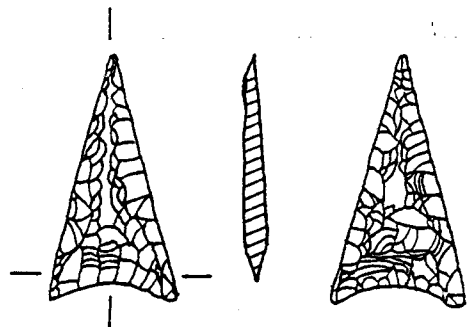
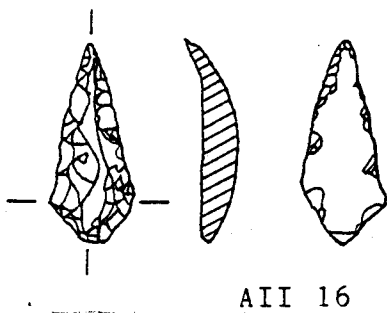
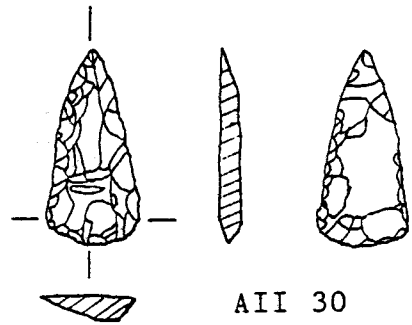
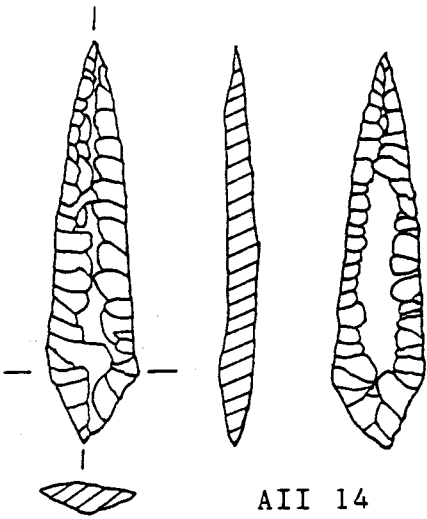
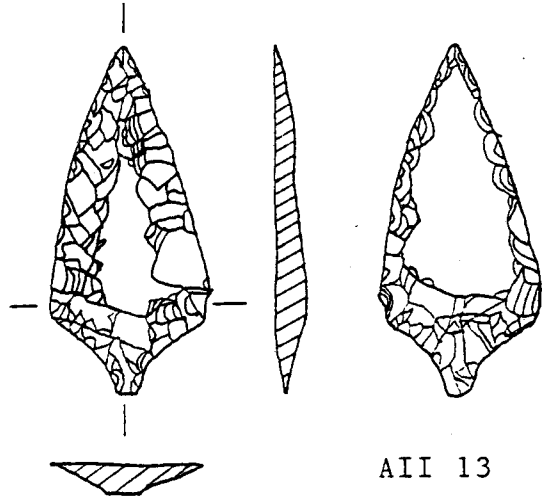
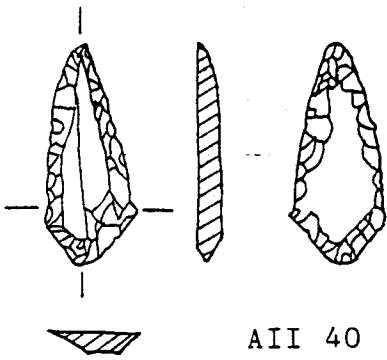
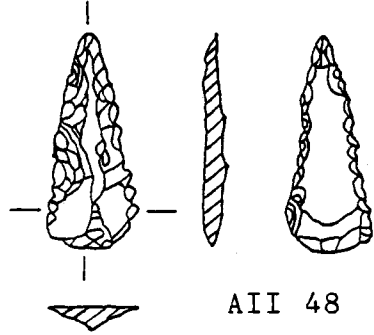
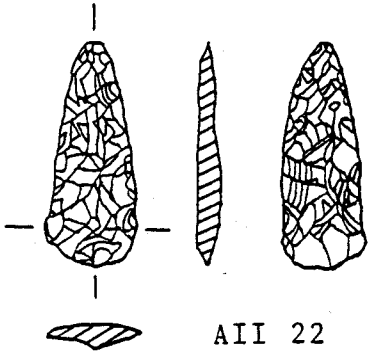

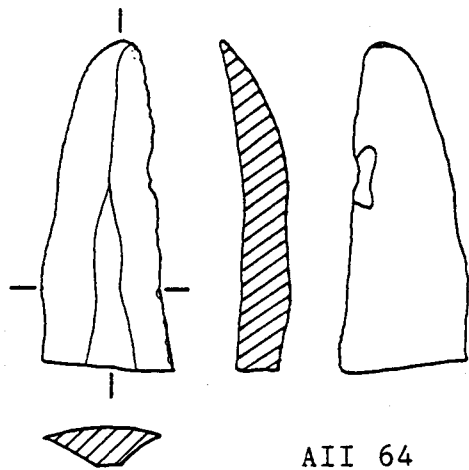

AII 64

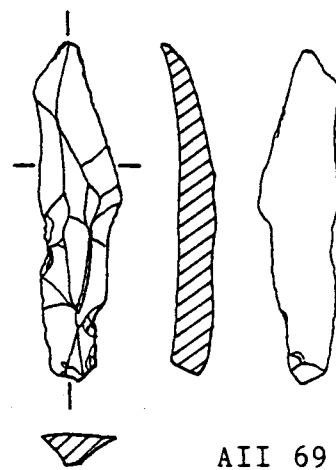

AII 69

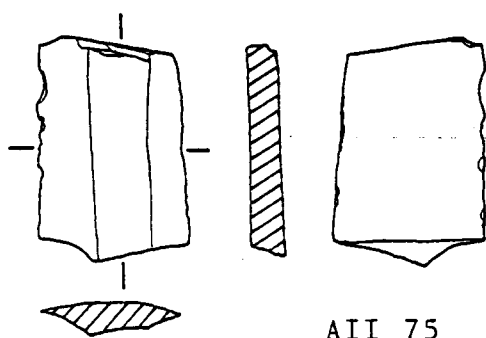

AII 75

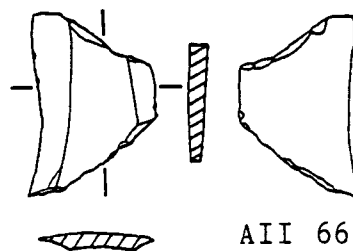

AII 66

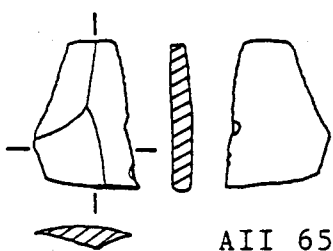

AII 65

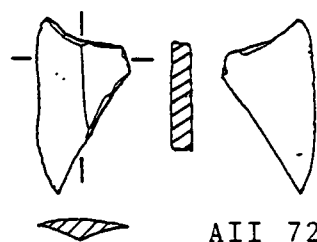

AII 72

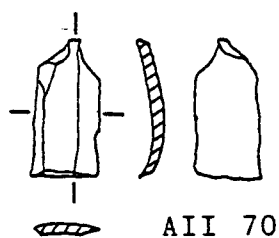

AII 70

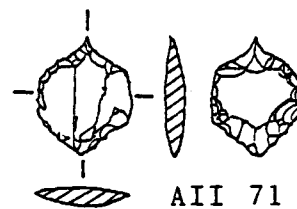

AII 71



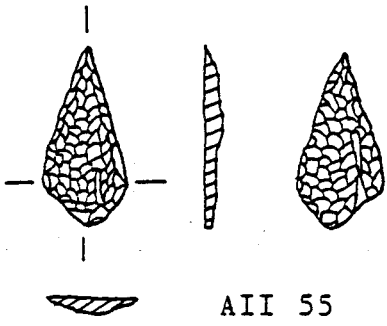

AII 55

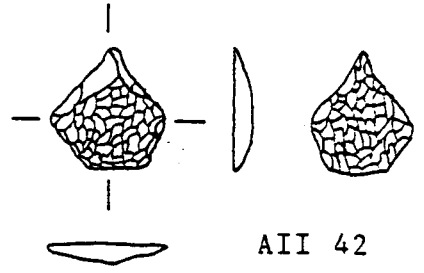

AII 42



AII 15

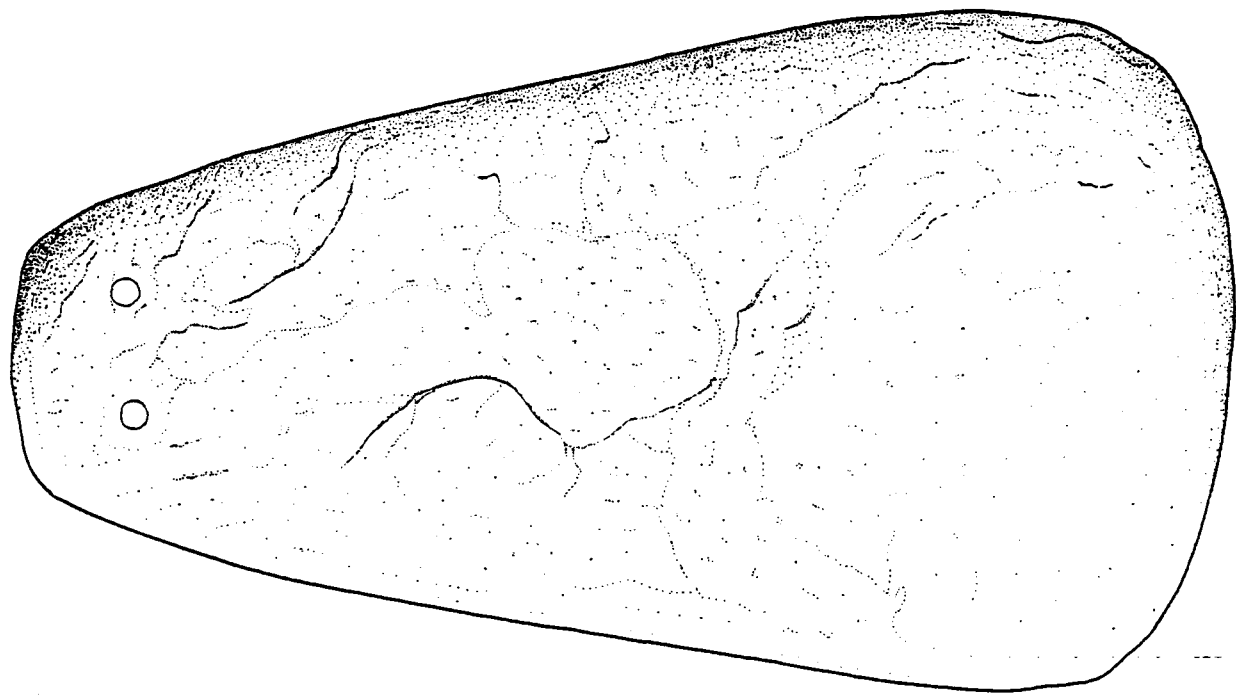

ATI 10

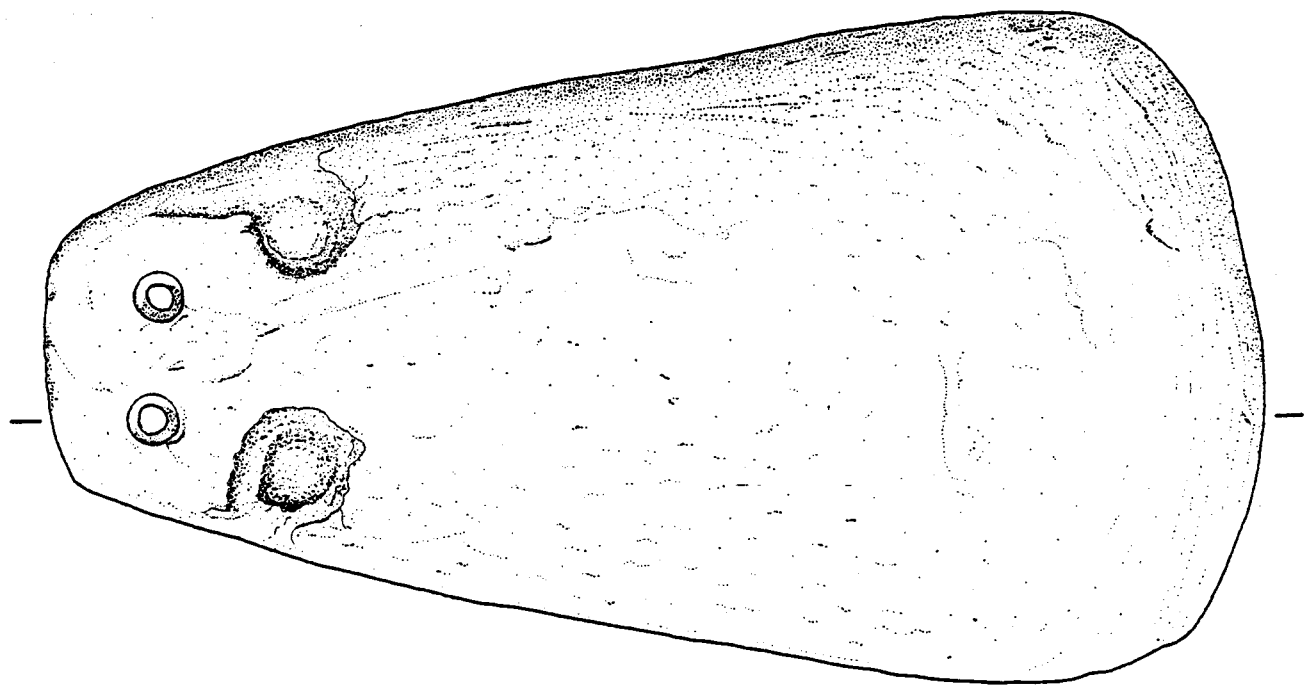
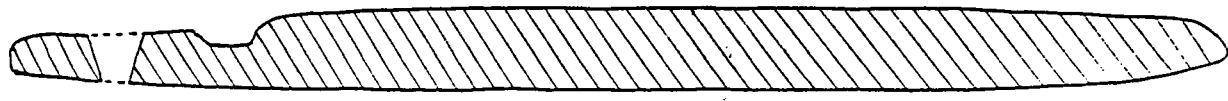

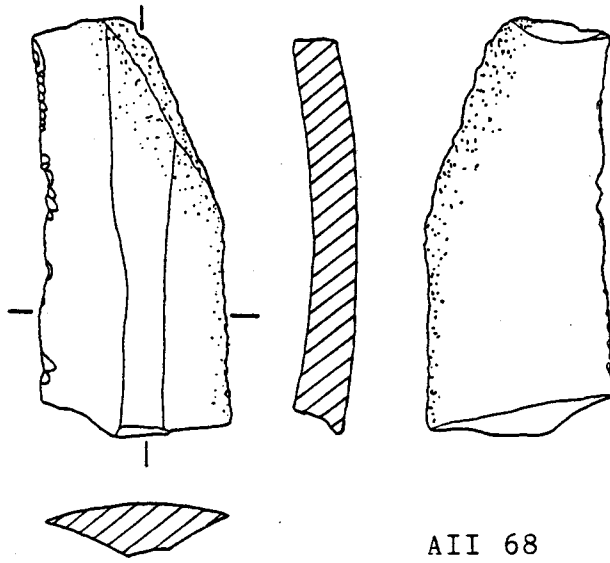

AII 68

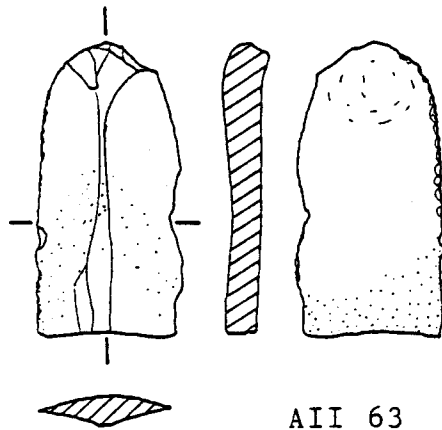

AII 63

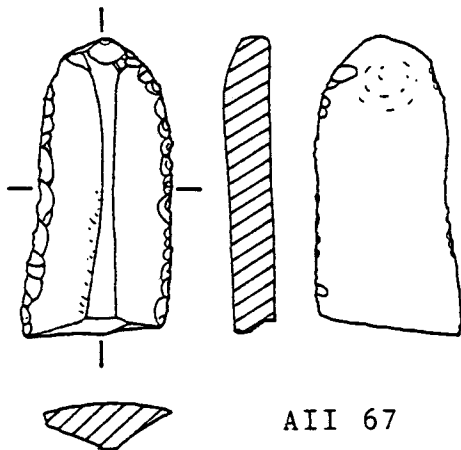

AII 67

ANTA  
**III do ALCOGULO**



AIII 1

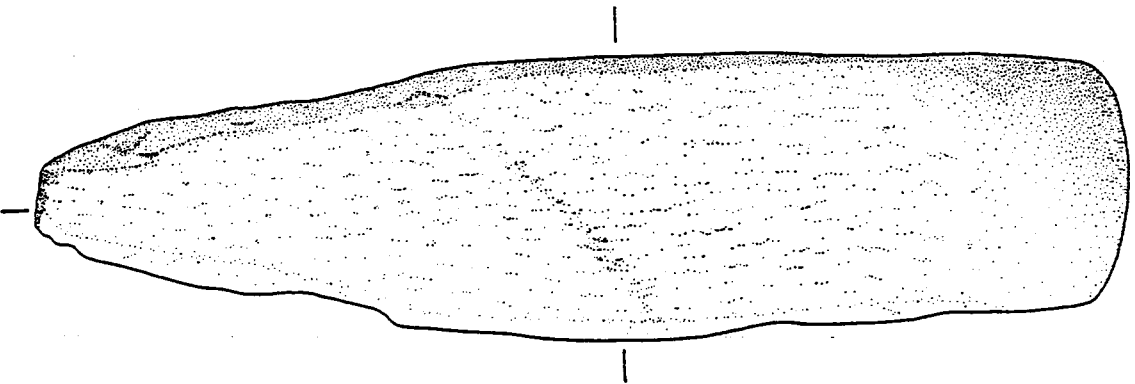
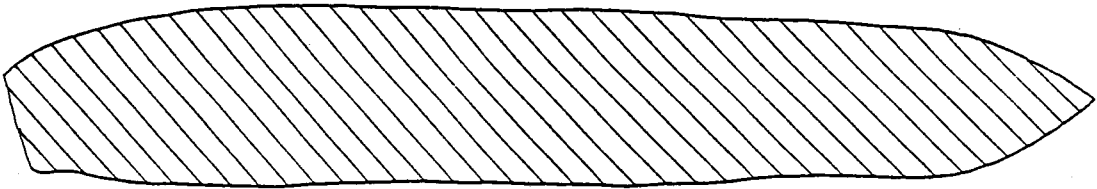
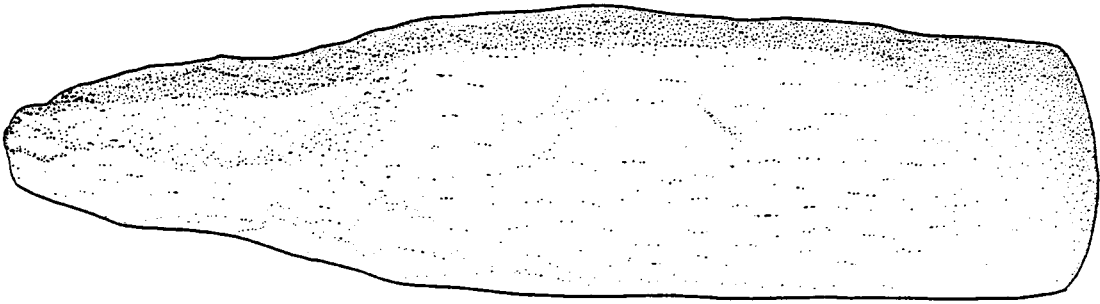



ANTA  
**I do CEREJEIRO**





CE 2

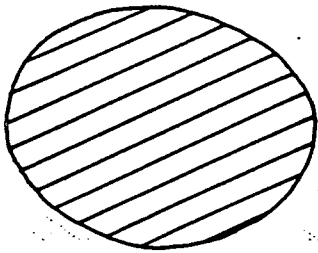
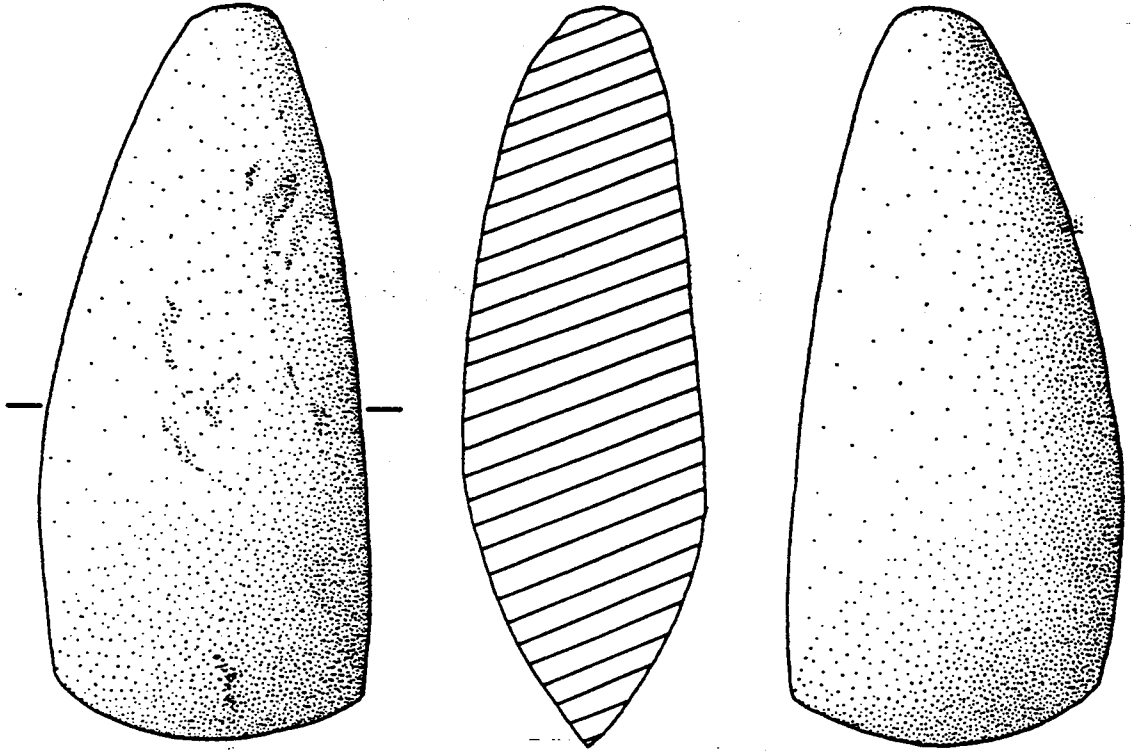

CE 2

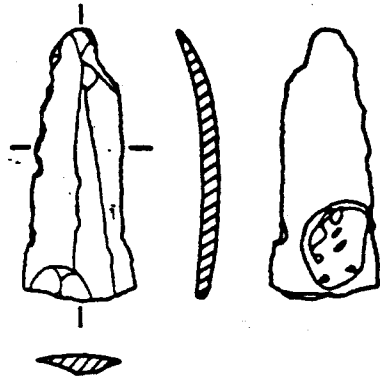

CE 1

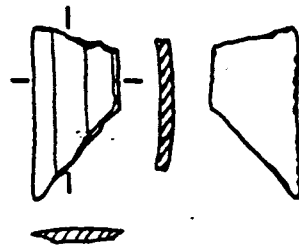

CE 3

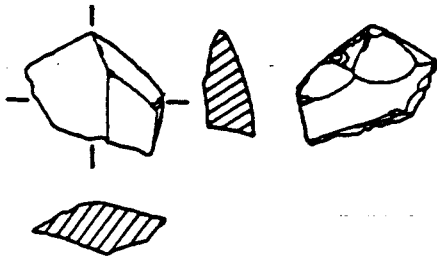

ANTA  
**I dos COURELEIROS**

100

CI 25

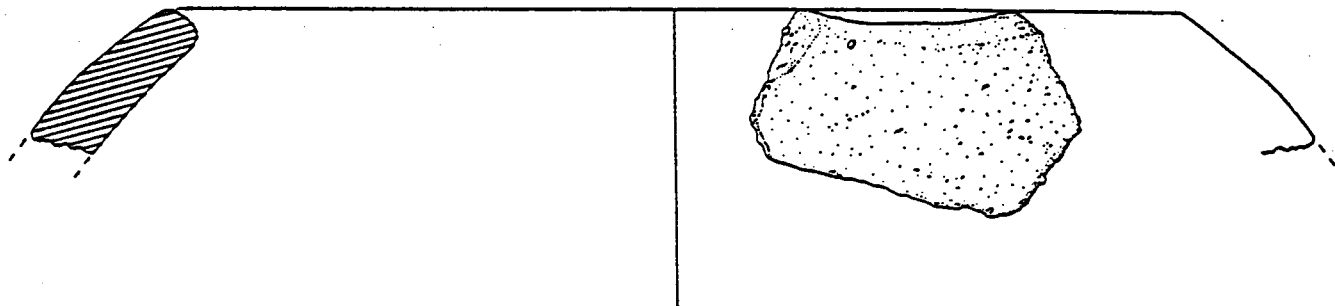

CI 21

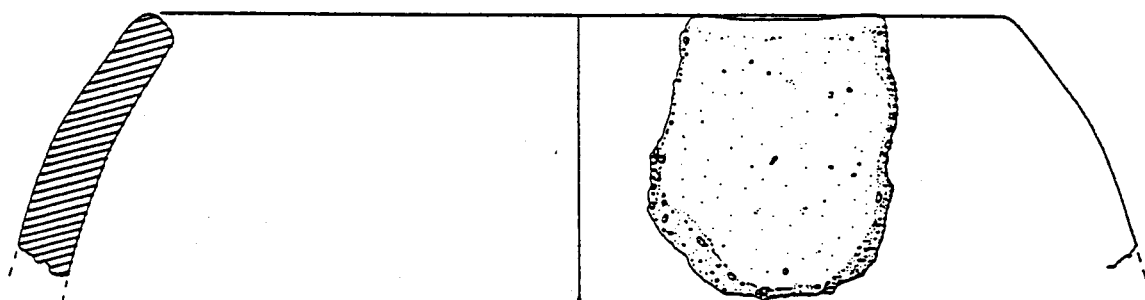

CI 26

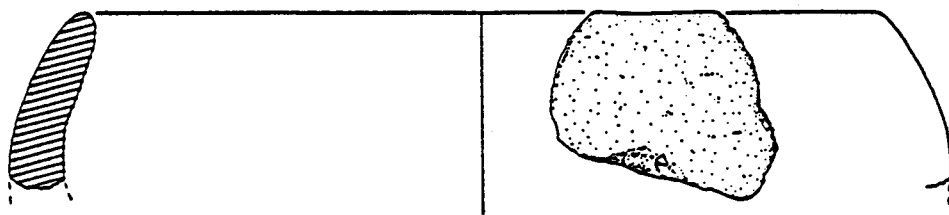

0 5cm

CI 22

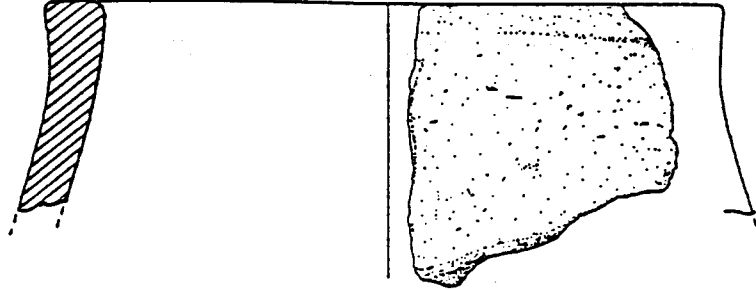

CI 20

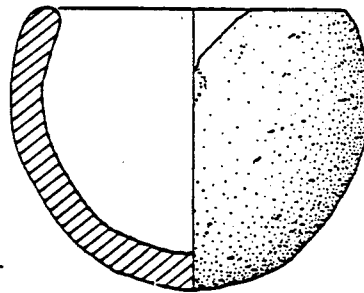

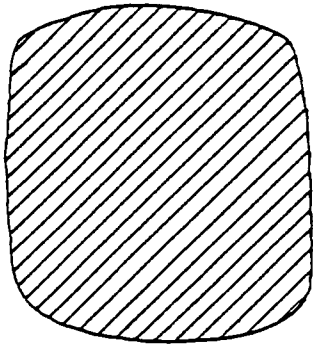
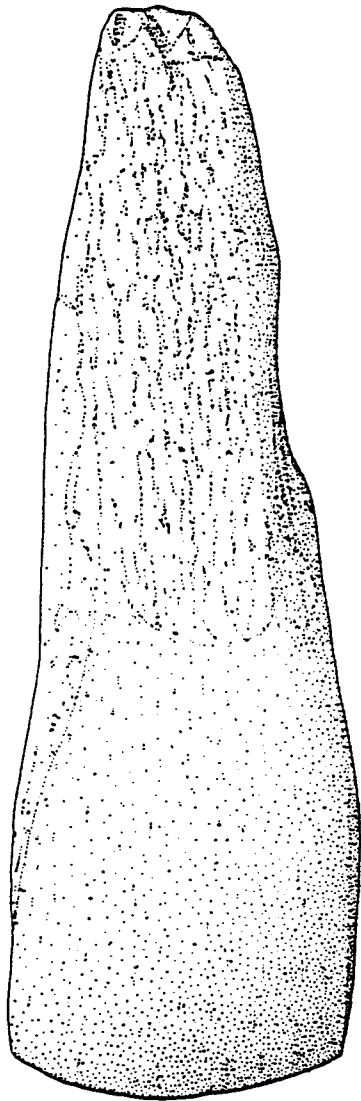
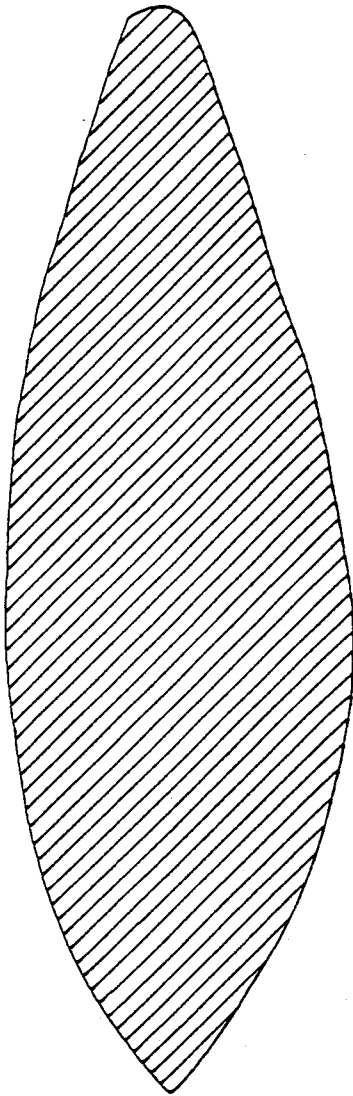
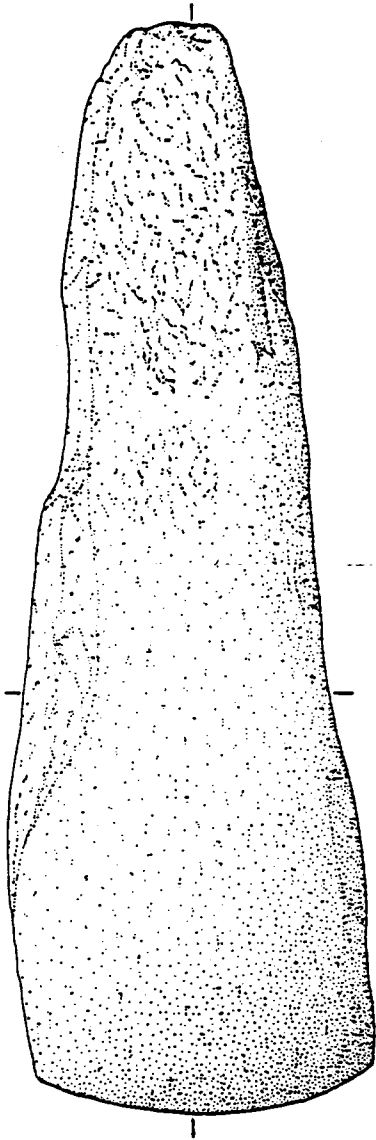



CI 6

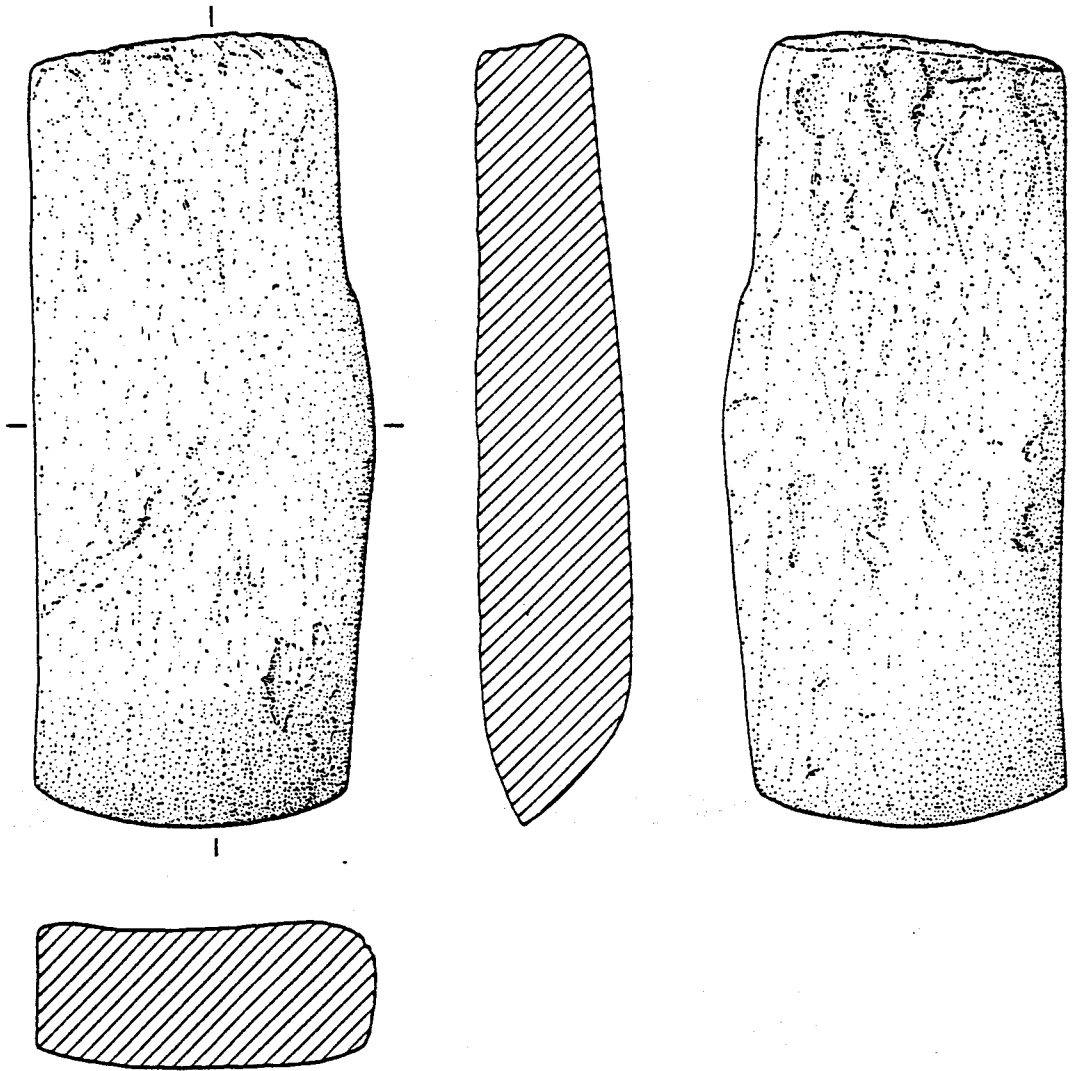

0 5 cm

CI 16

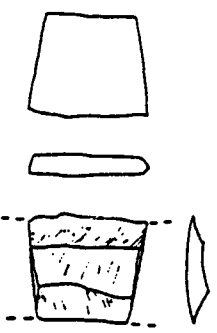

CI 29

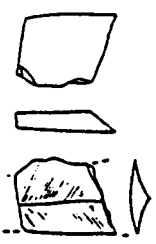

CI 15

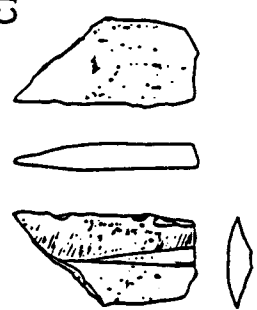

CI 12

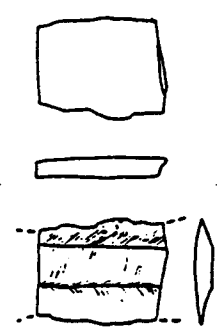

CI 11

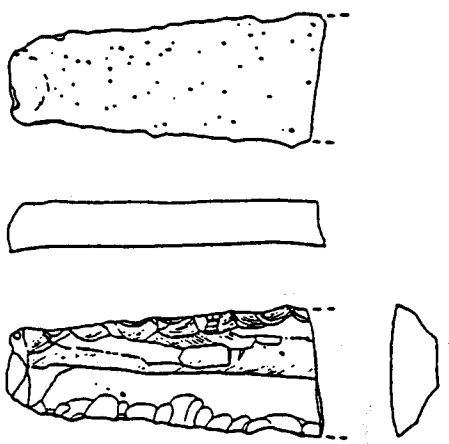

CI 13



CI 28

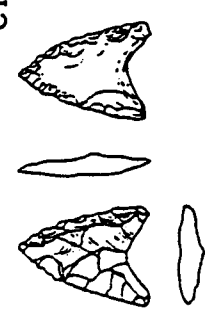

CI 17

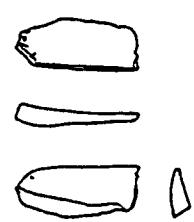

CI 27

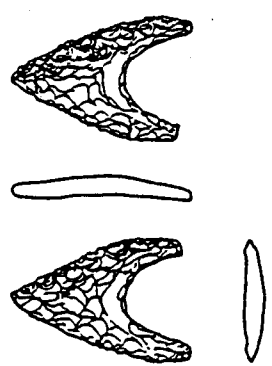

CI 14

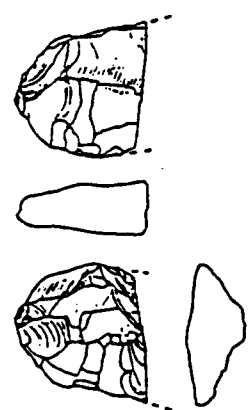

0  
5cm

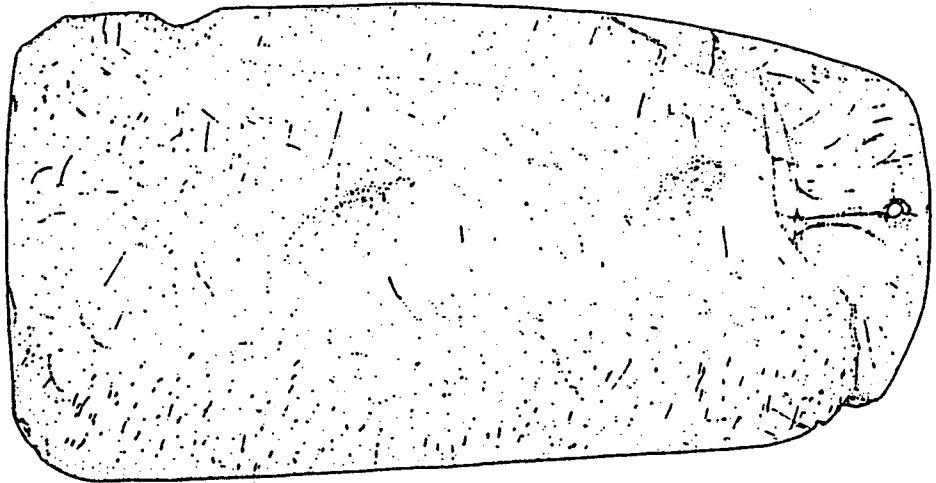
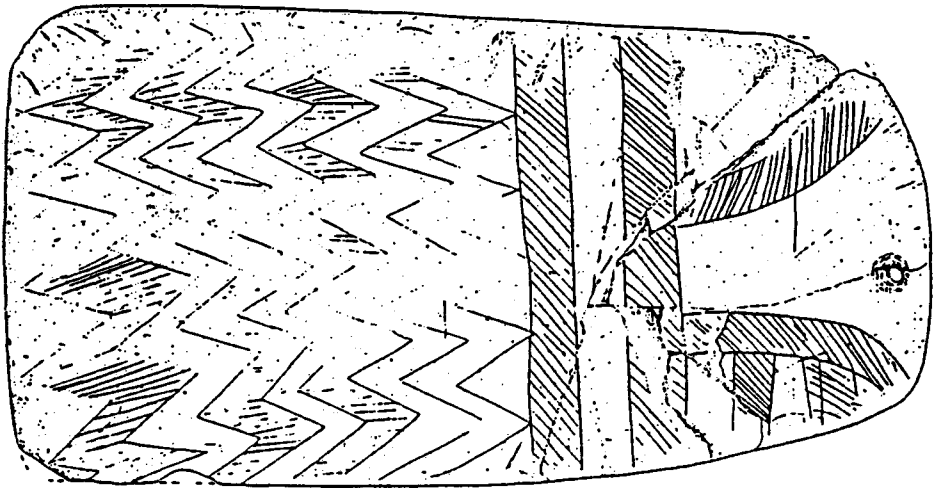

C13

C12

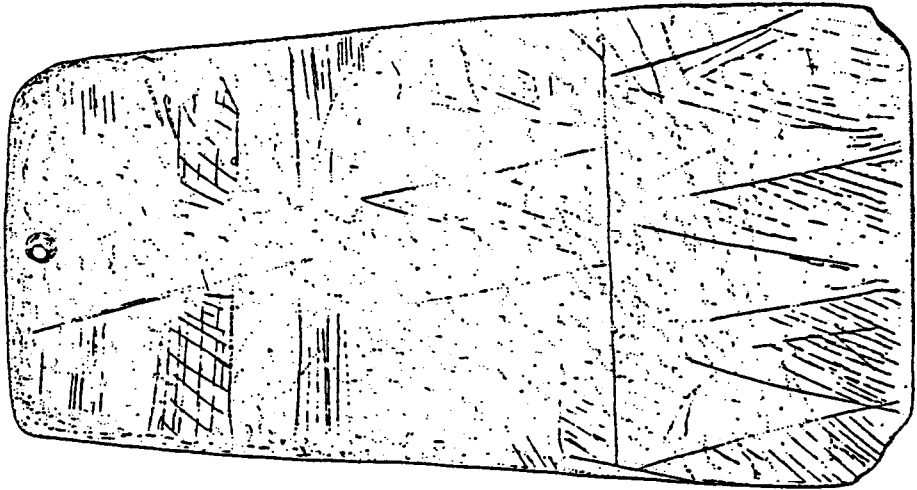
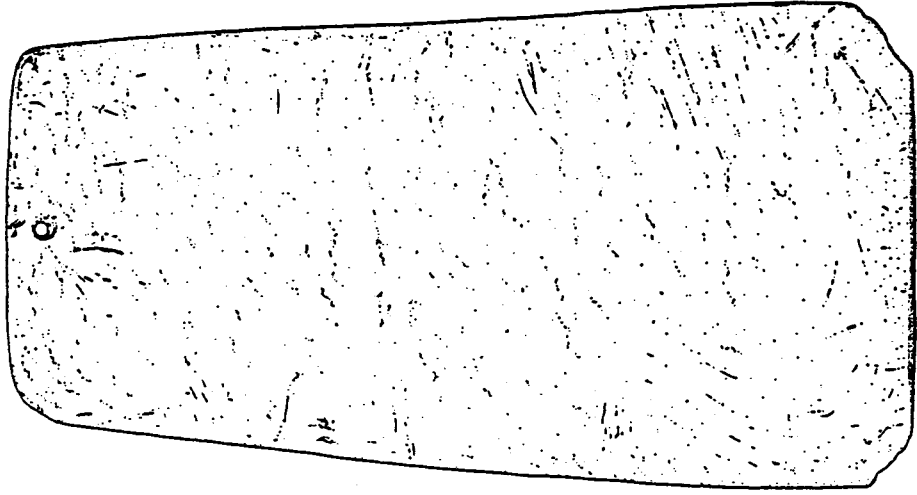

0  
5 cm

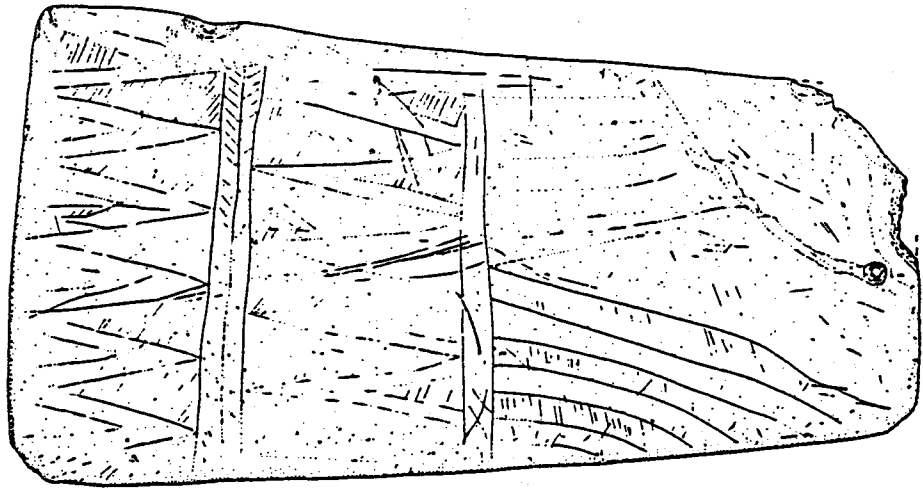
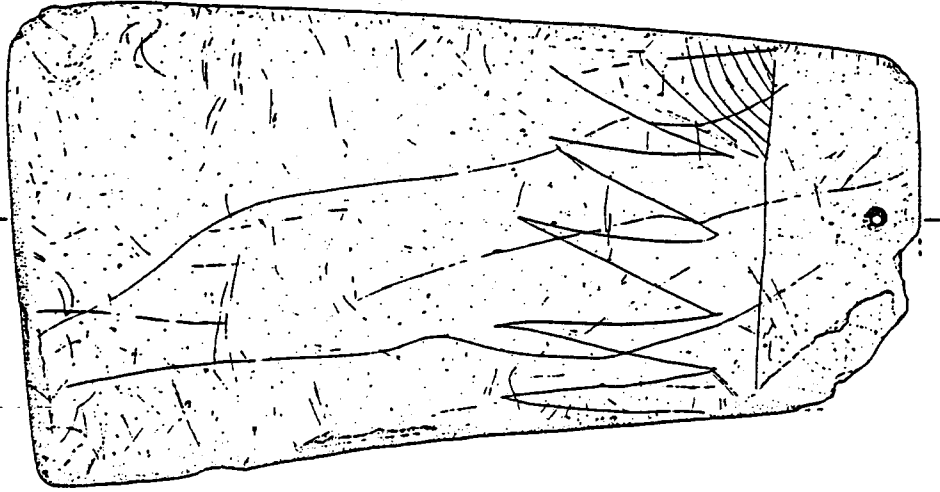

C11

C13

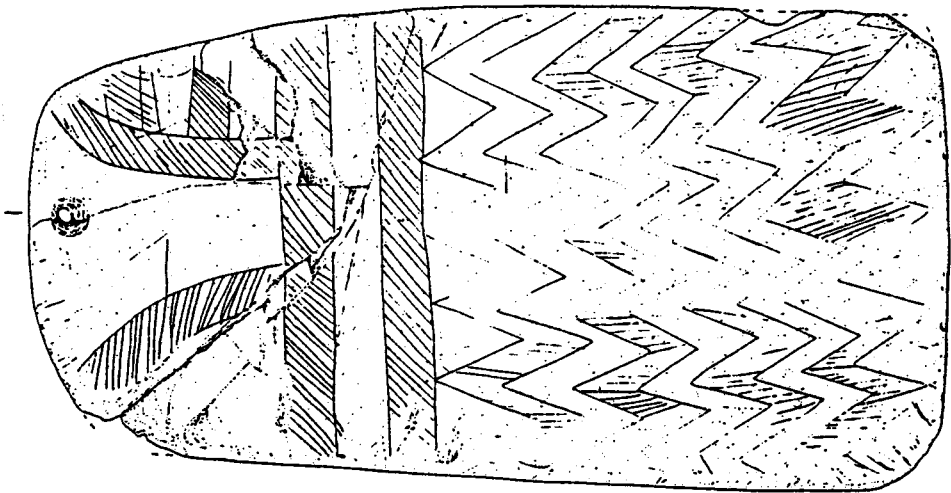
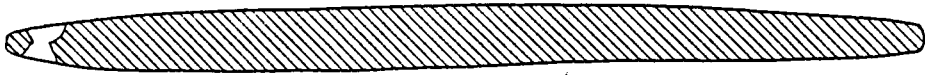
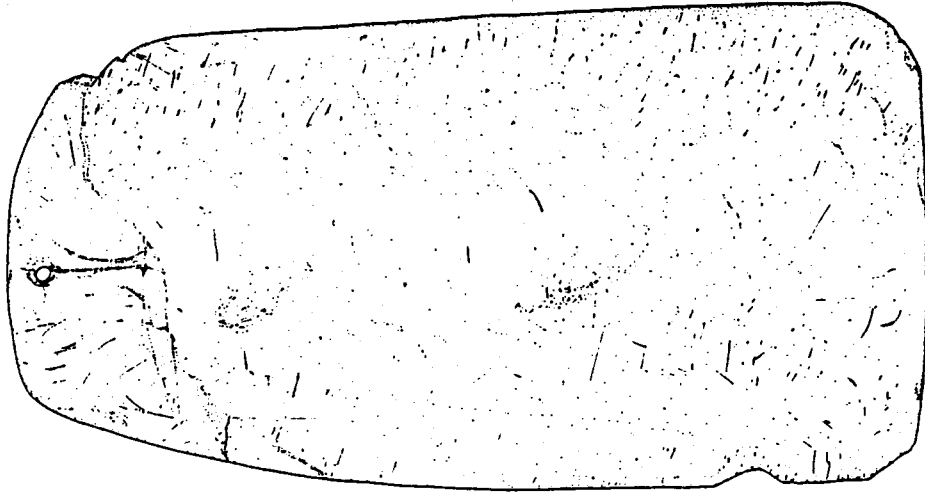

0  
5 cm

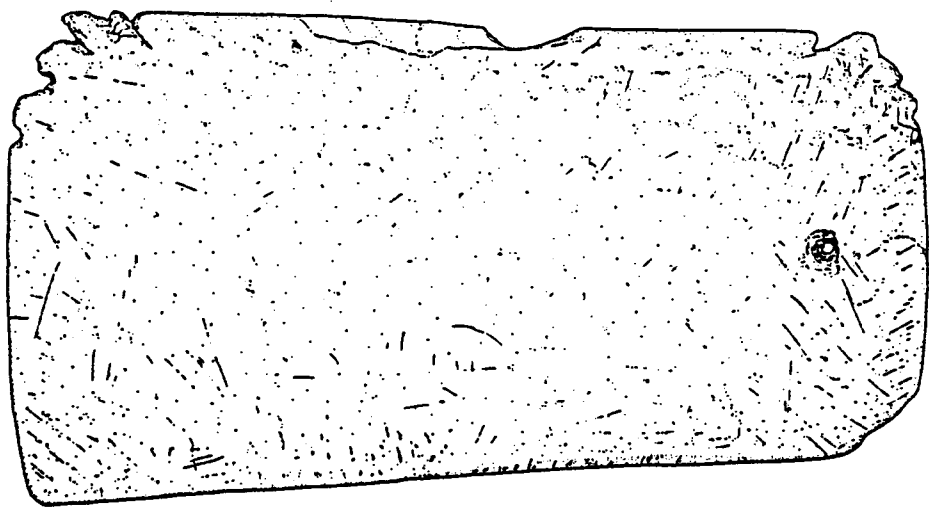
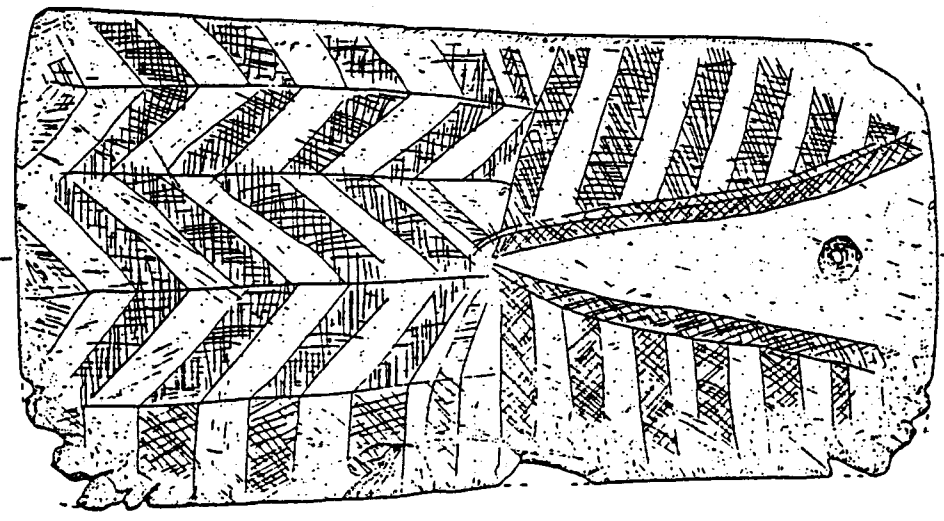

C14

C15

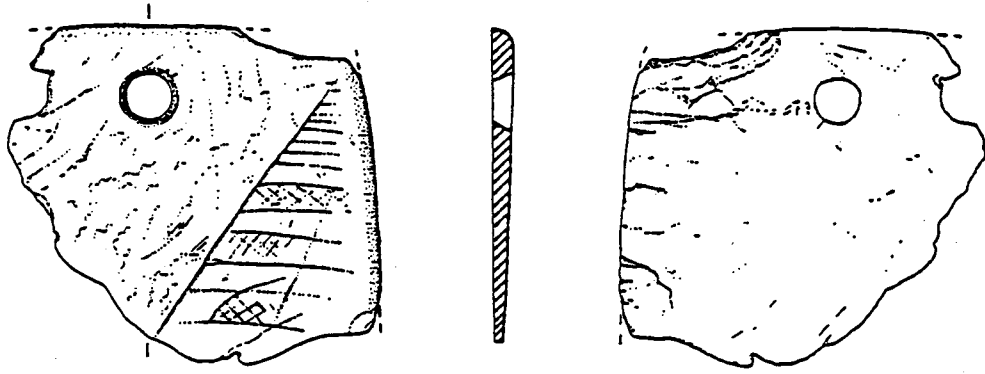



CI 10

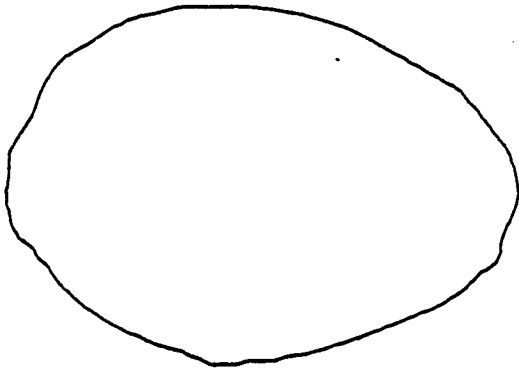
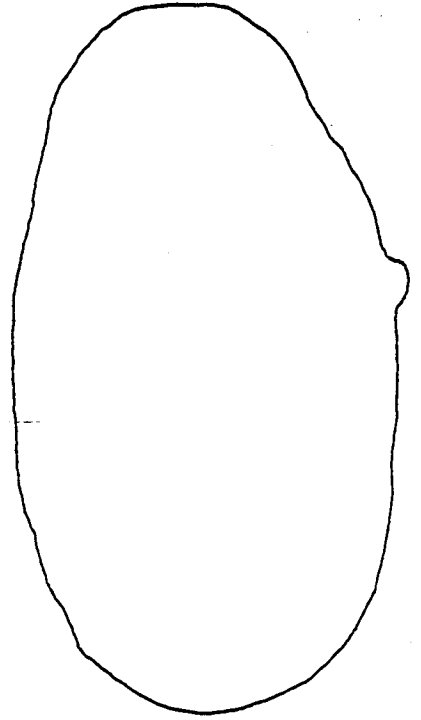
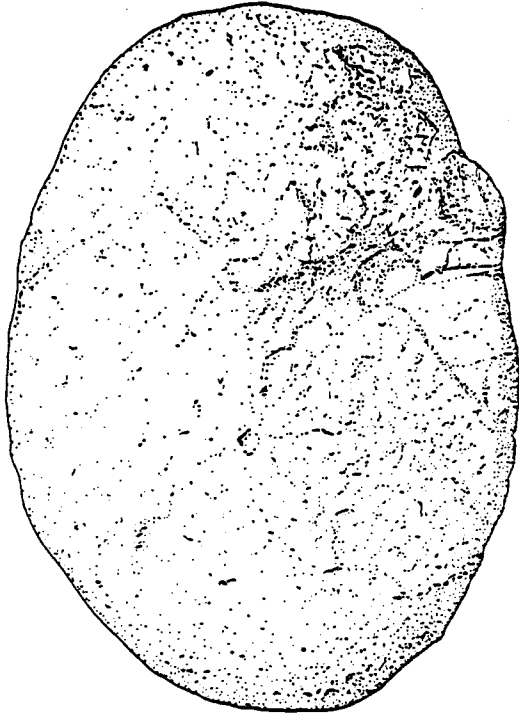

ANTA  
**II dos COURELEIROS**



59 CII

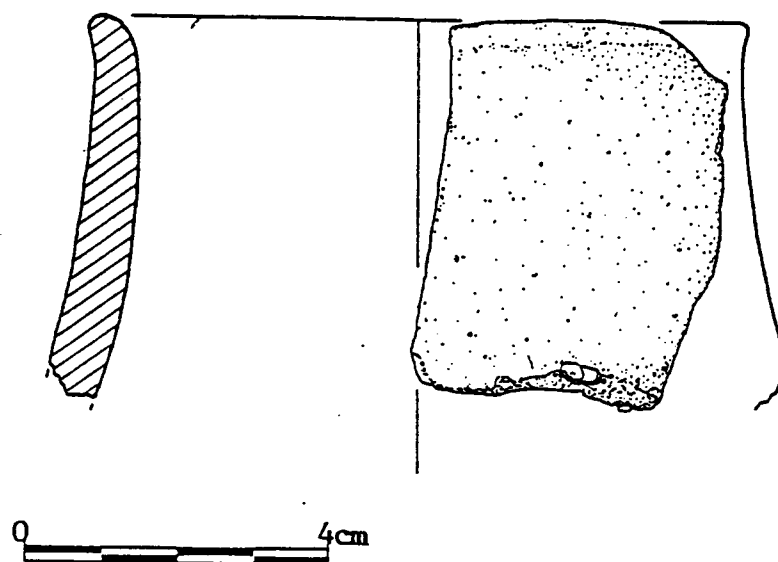

54 CII

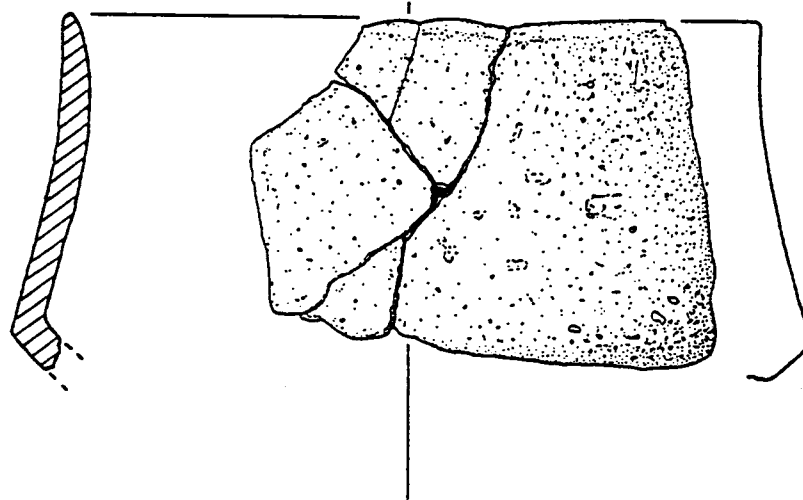

52 CII

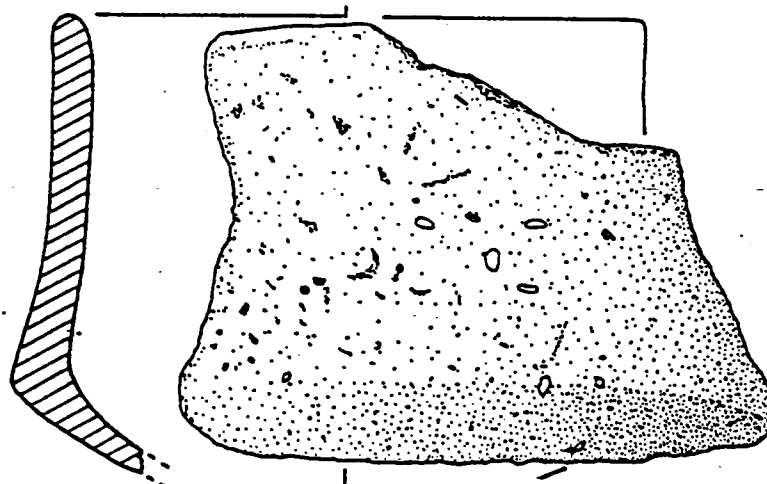

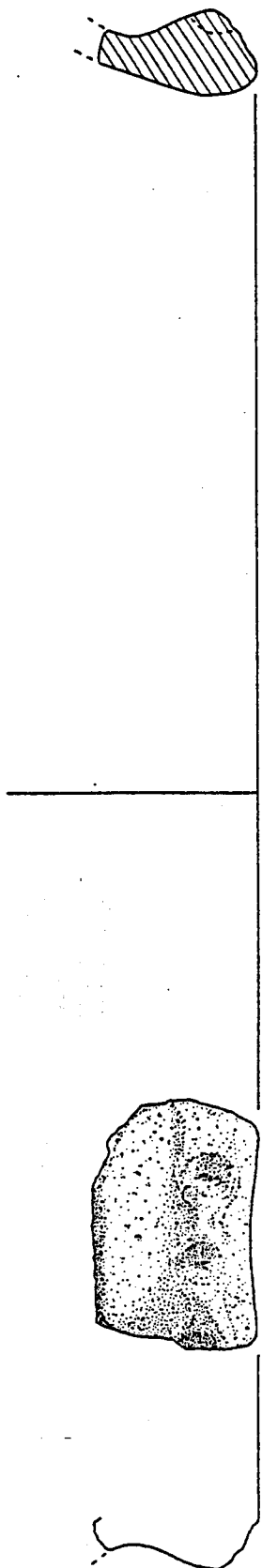

58 CII

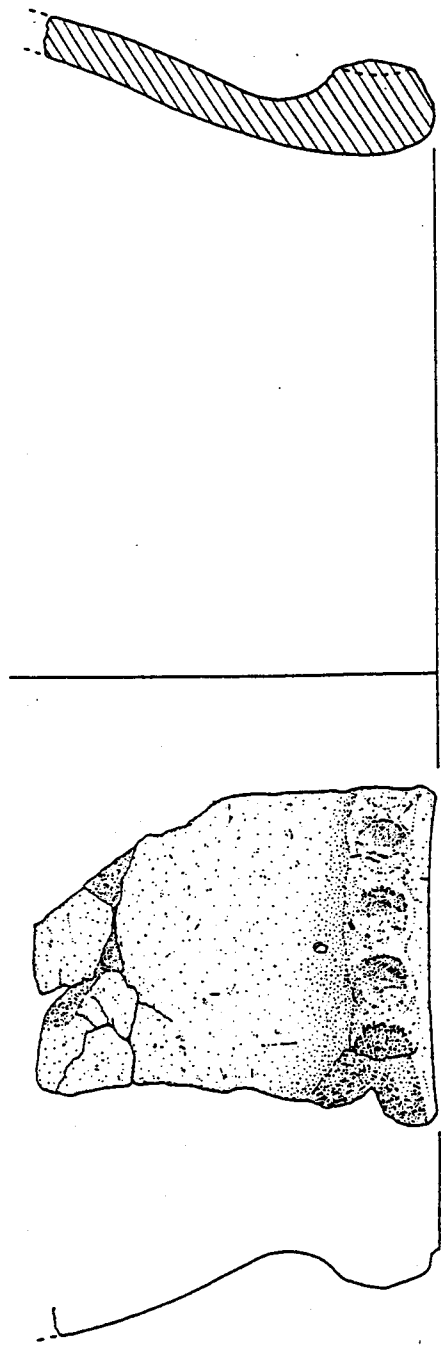

3

47 CII

53 CII

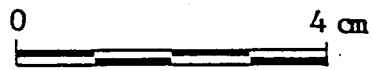
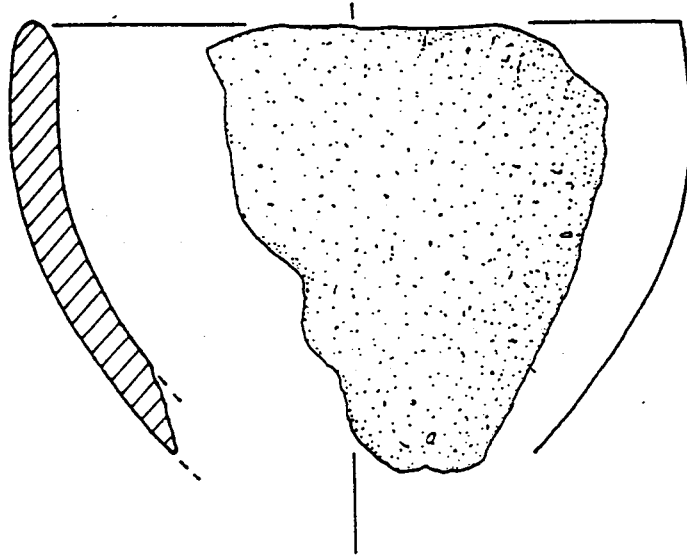

55 CII

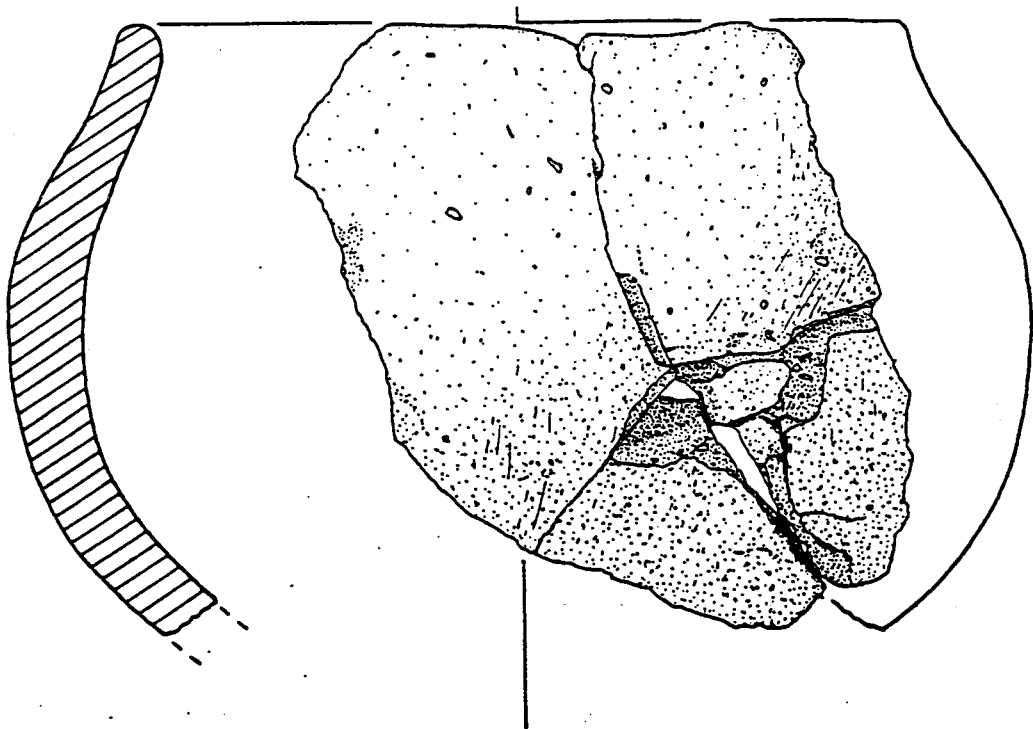

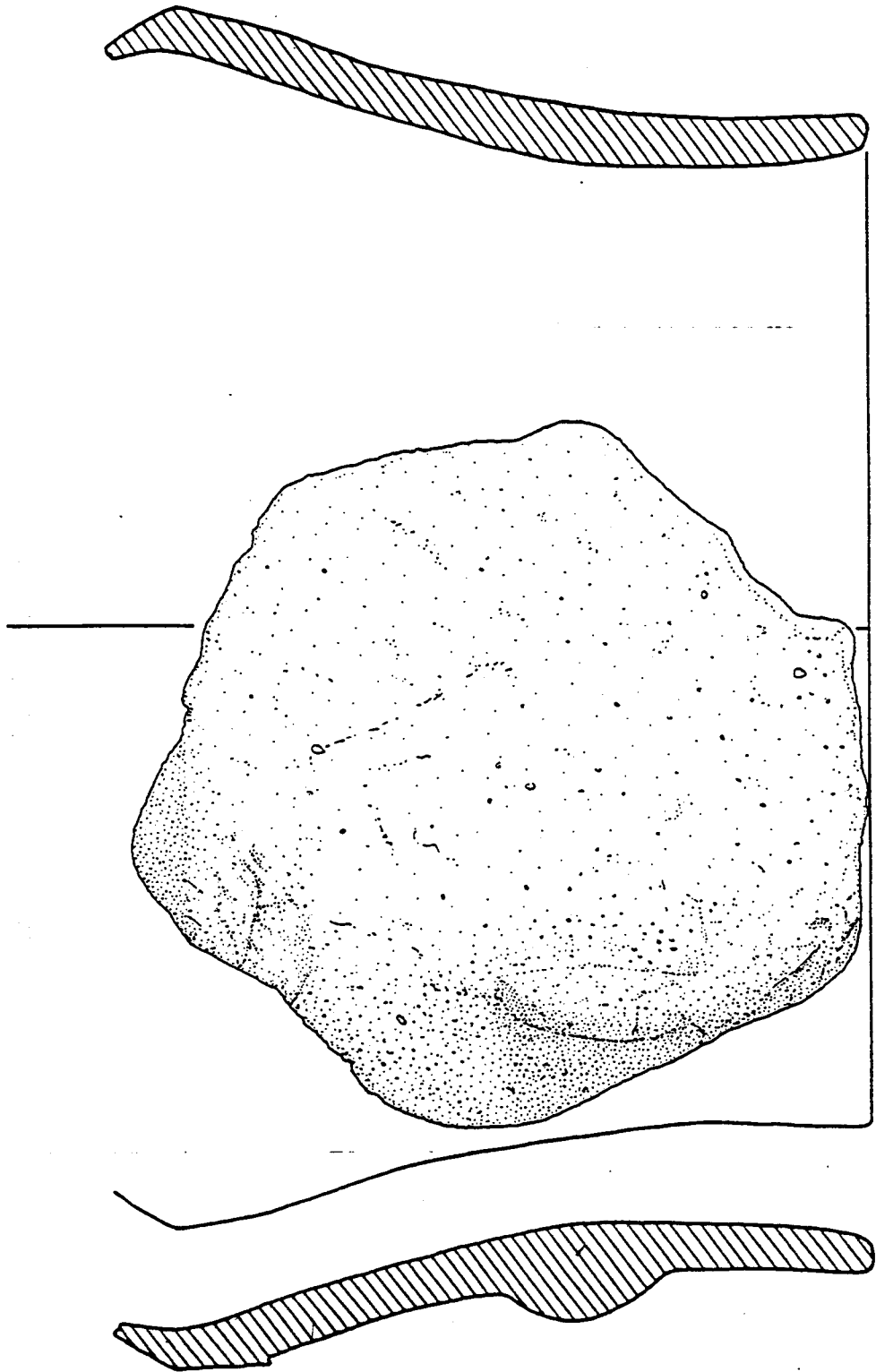

48 CII

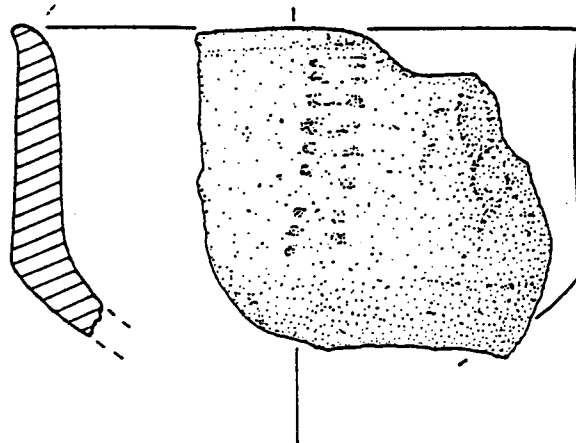

49 CII

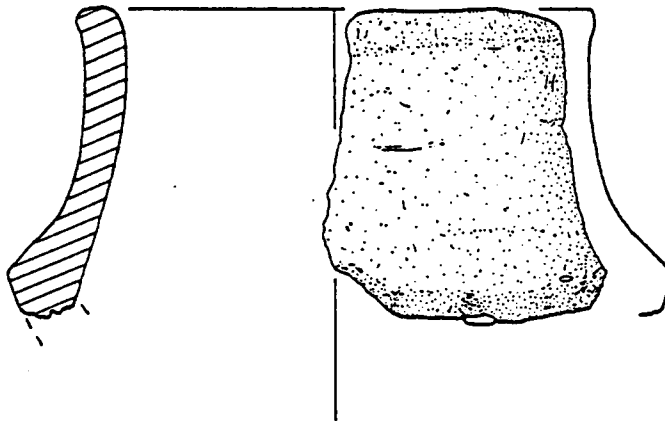

57 CII

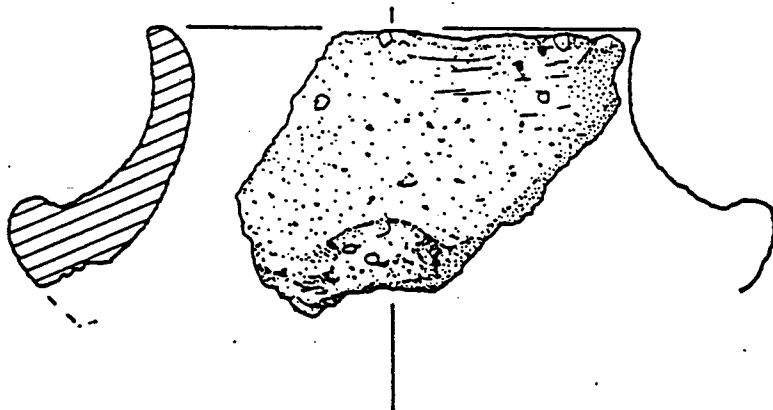



4, cm

0

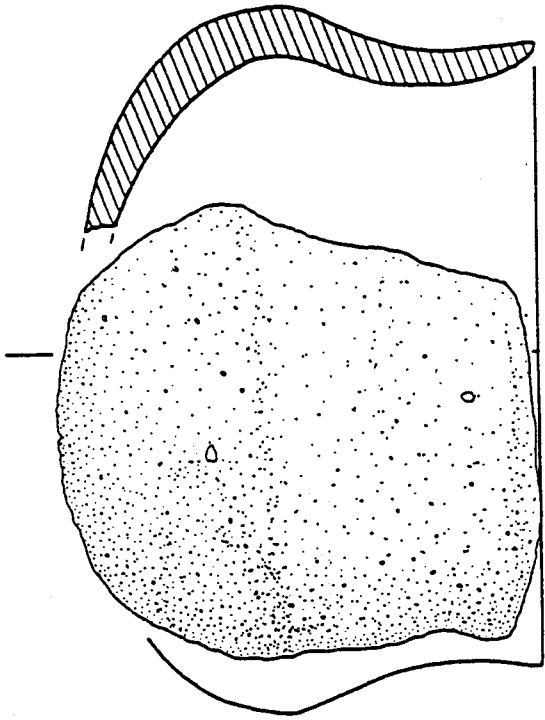

61 CH

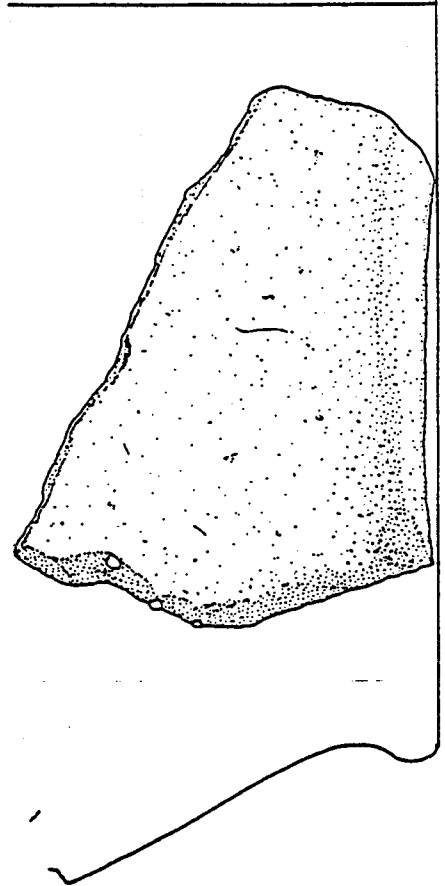
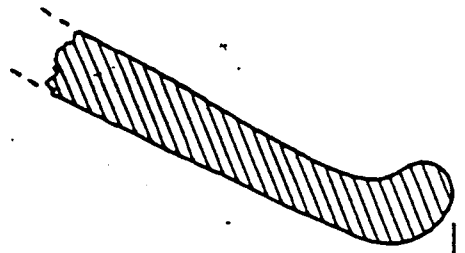

62 CH

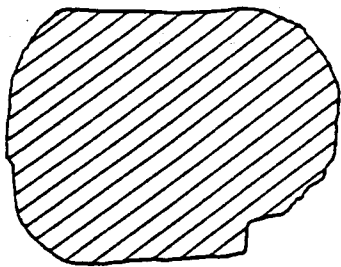
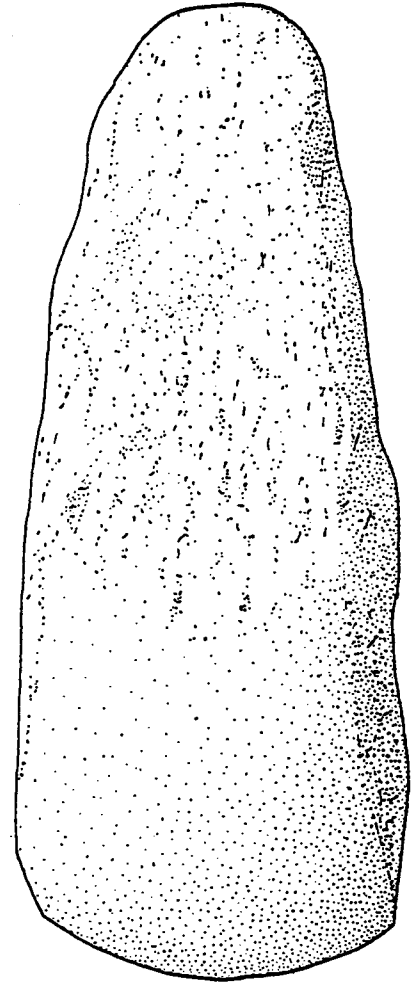
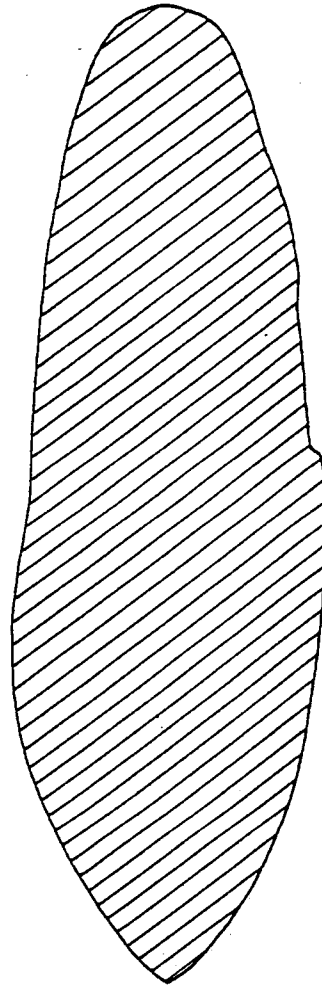
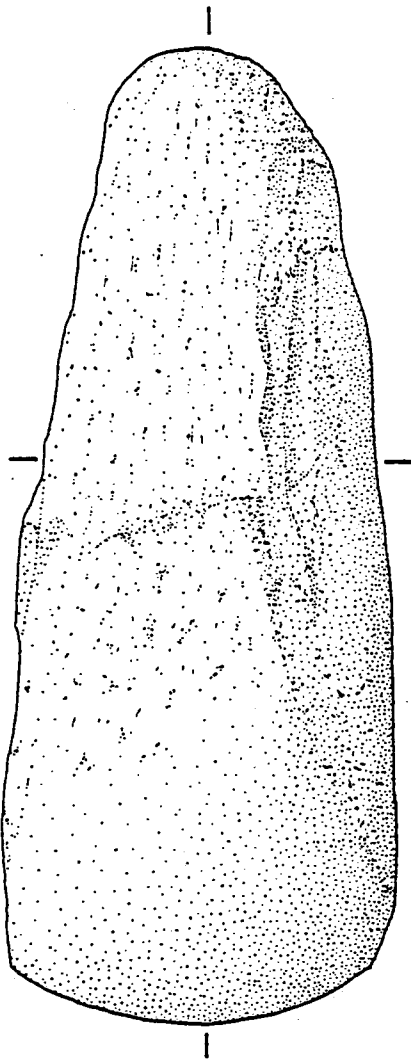

17 CII

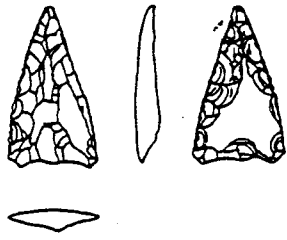

2 CII

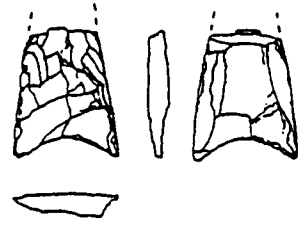

4 CII

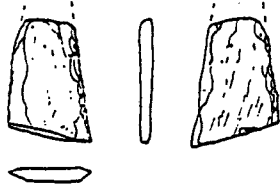

3 CII

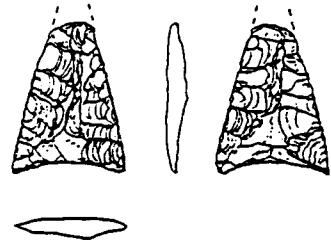

6 CII

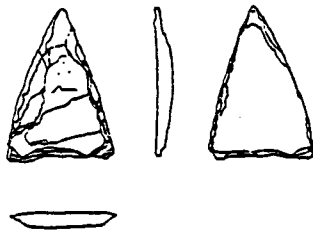

16 CII

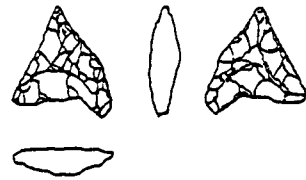

5 CII

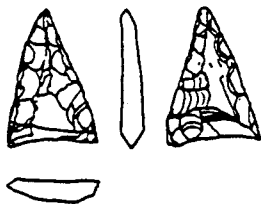

13 CII

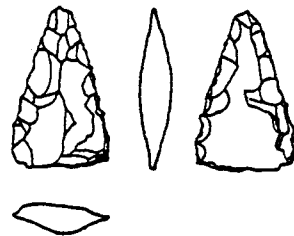

15 CII

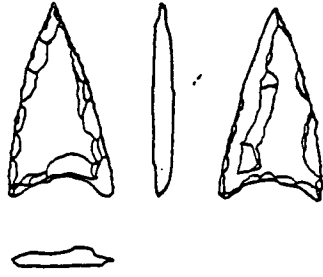

28 CII

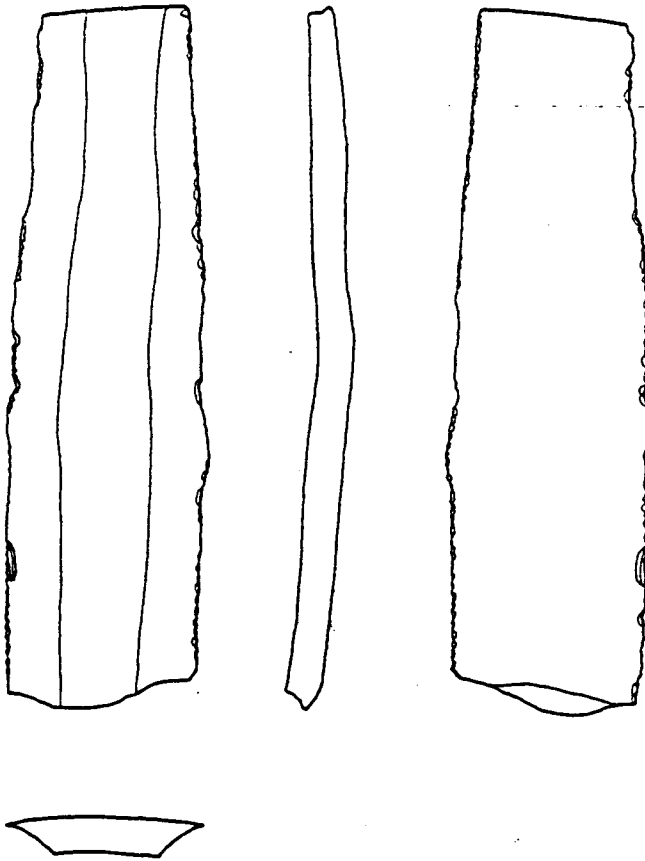

1 CII

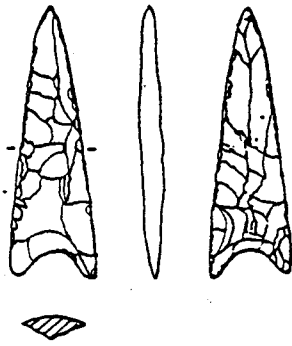

10 CII

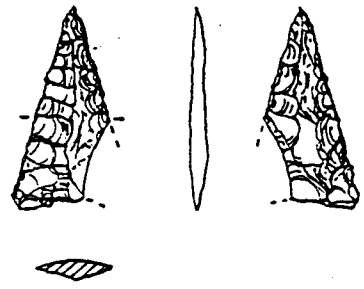

7 CII

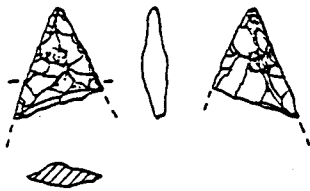

11 CII

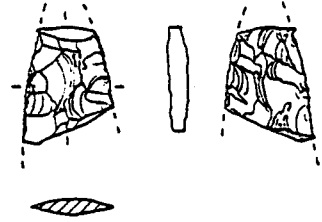

8 CII

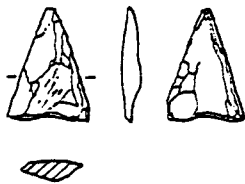

12 CII

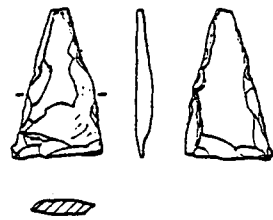

9 CII

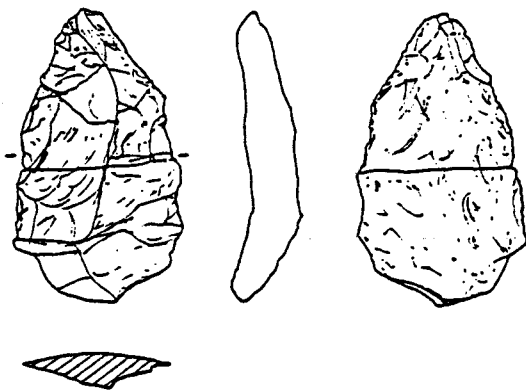

14 CII

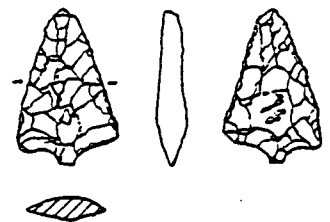

23 CII

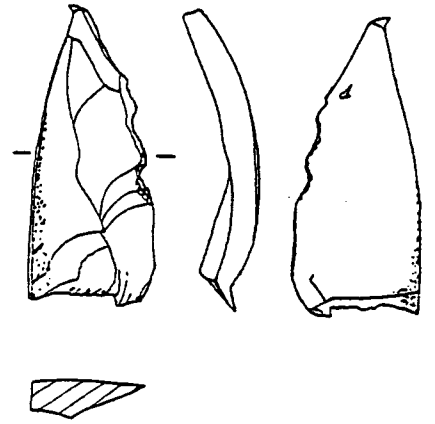
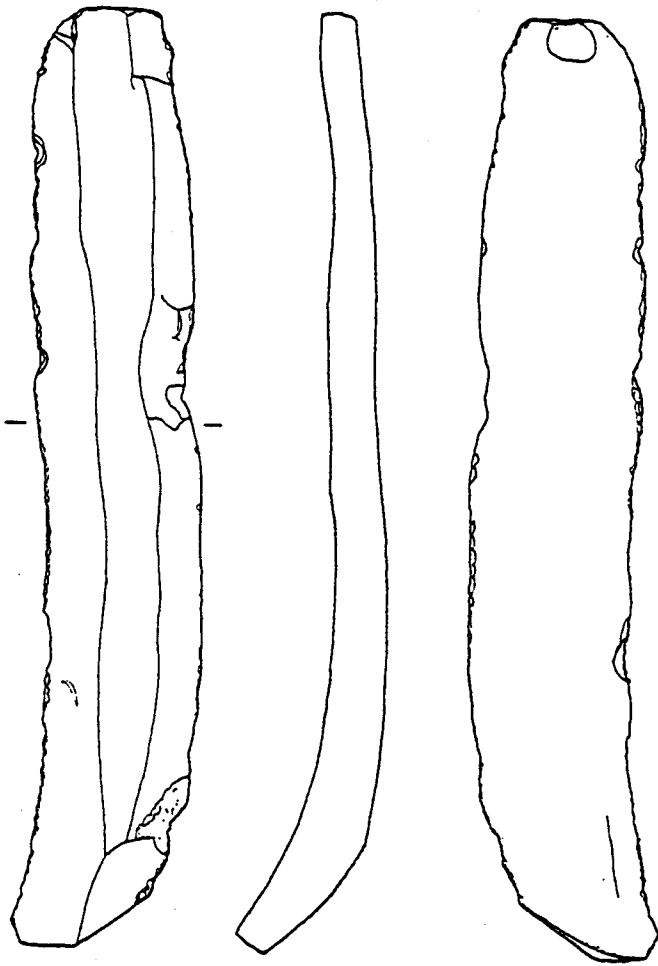

30 CII

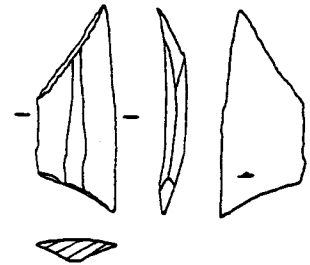

21 CII

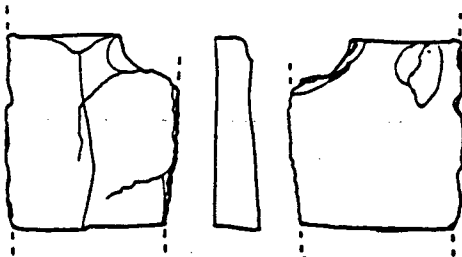
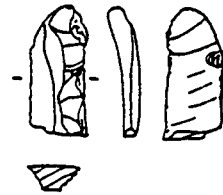

18 CII



24 CII

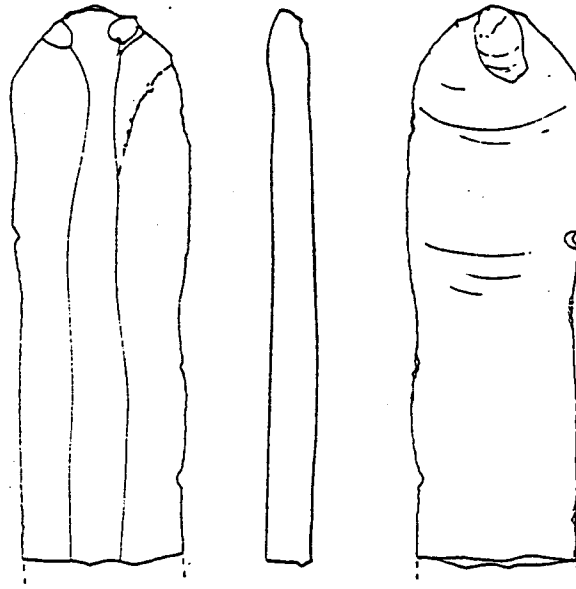

29 CII

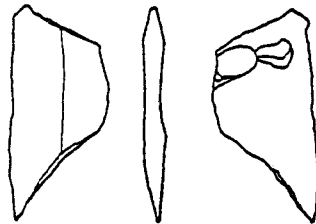

20 CII

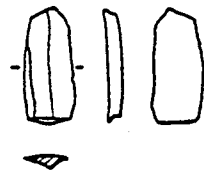

19 CII

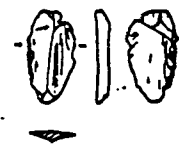

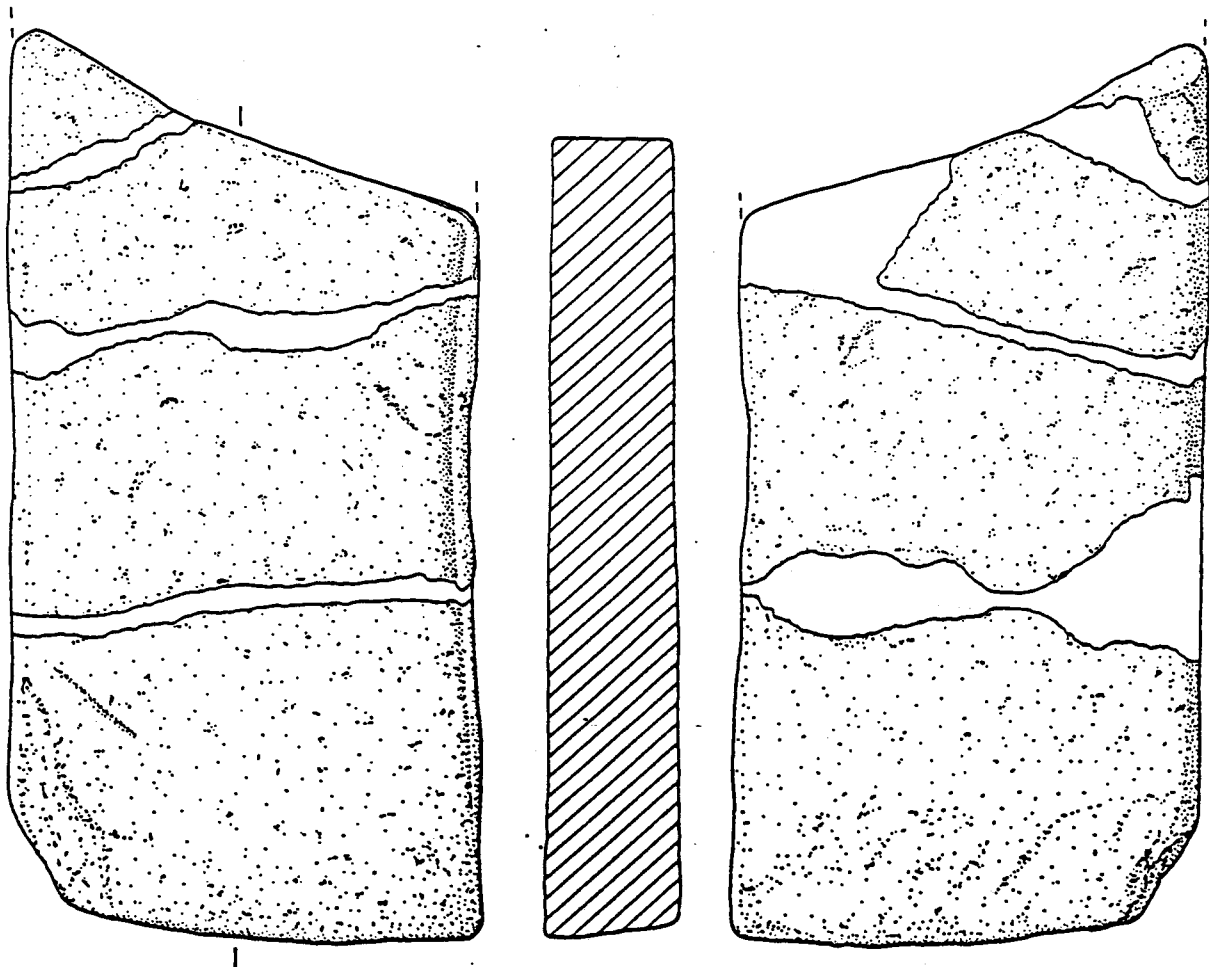
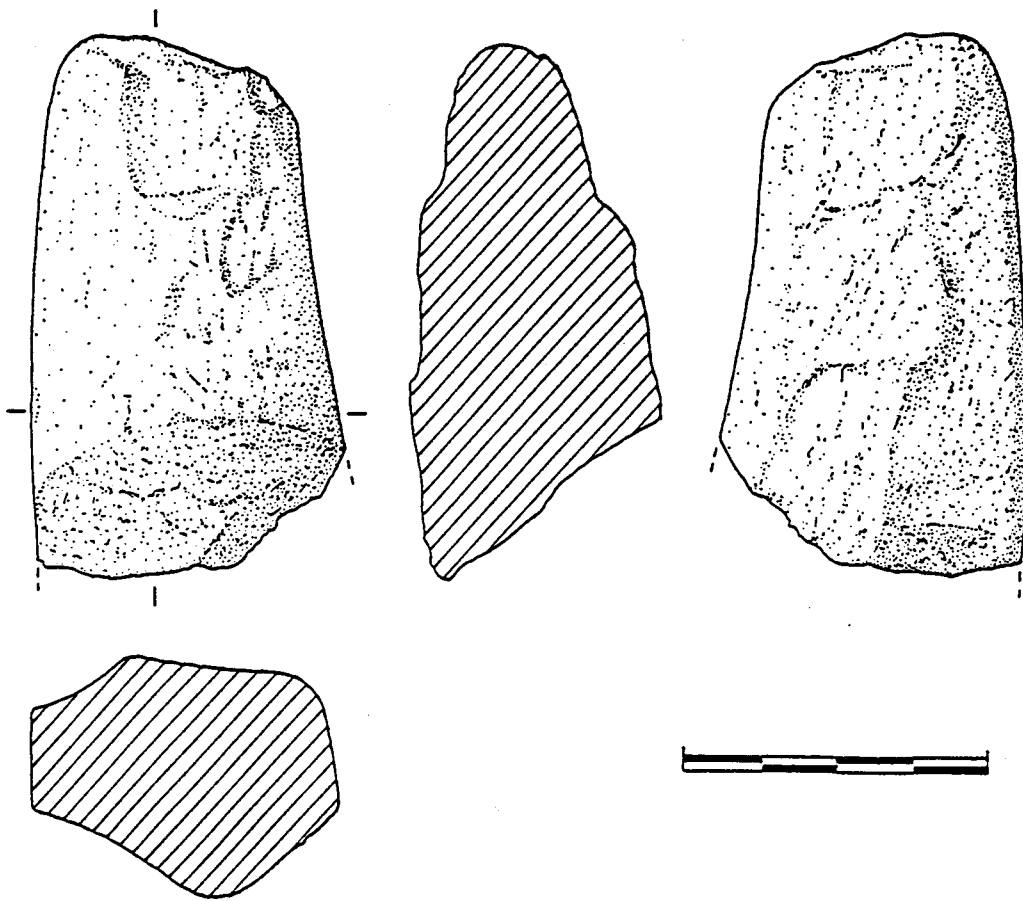



0  
4cm

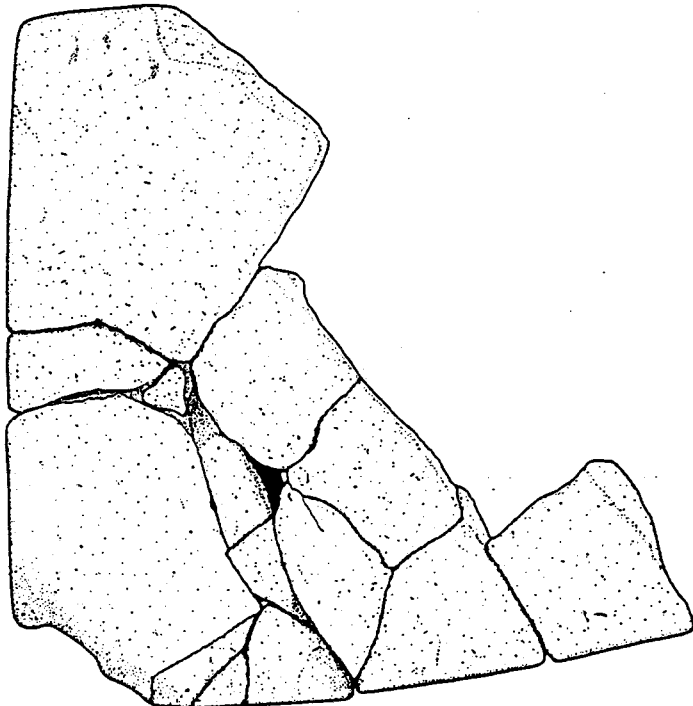
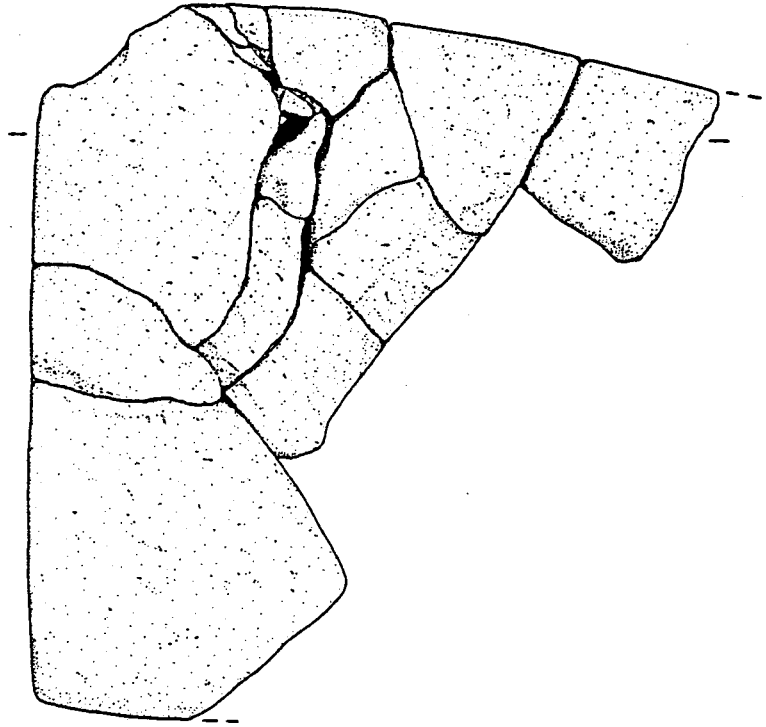

37 CII

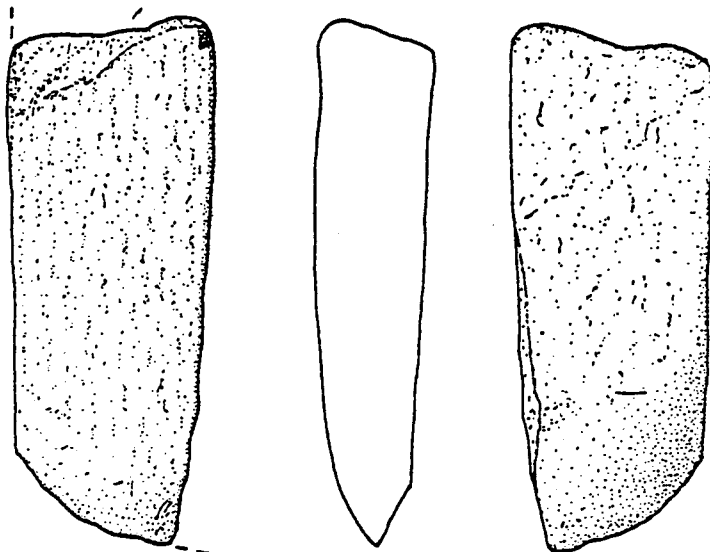

35 CII

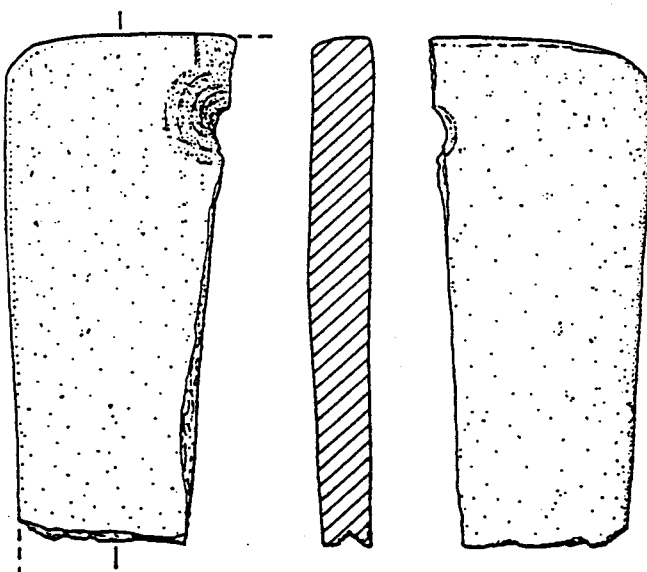

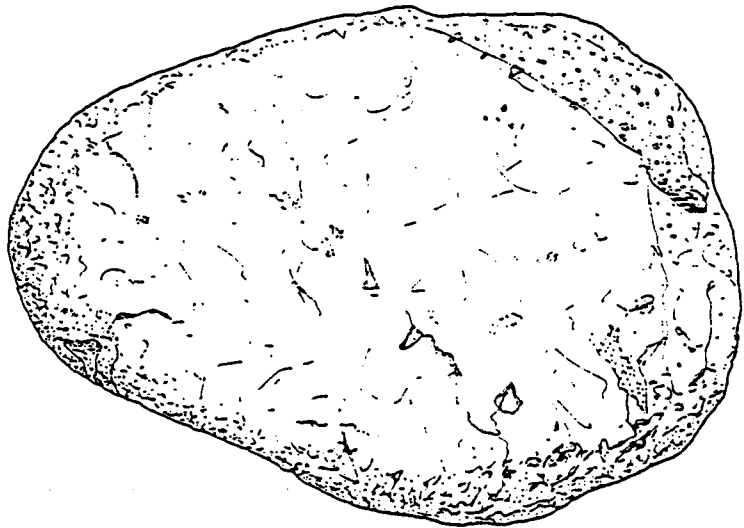
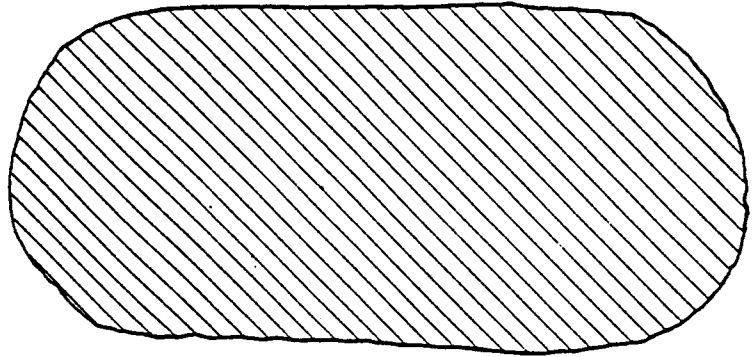
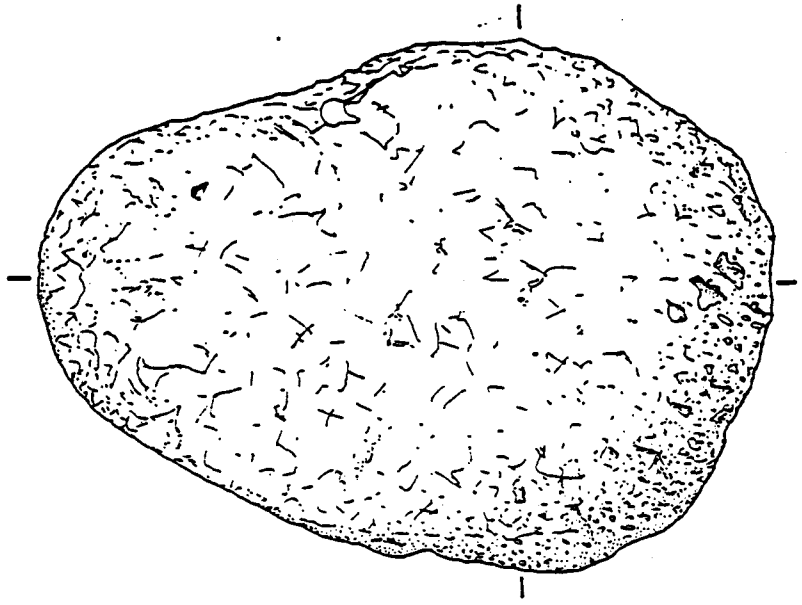
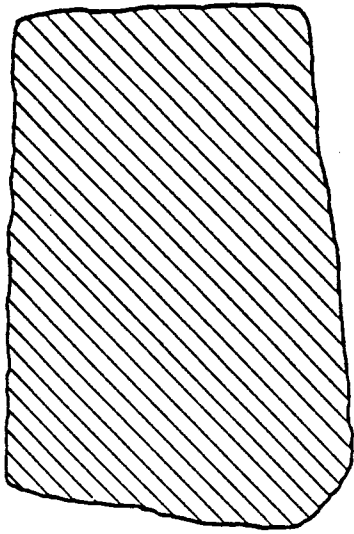

64 CII

43 CII

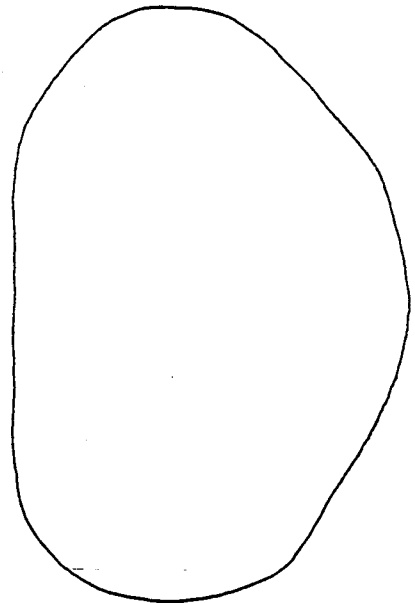
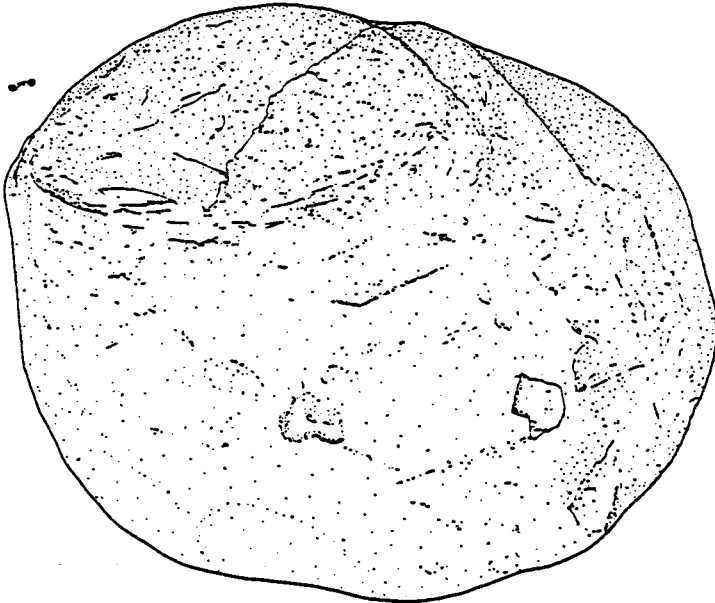
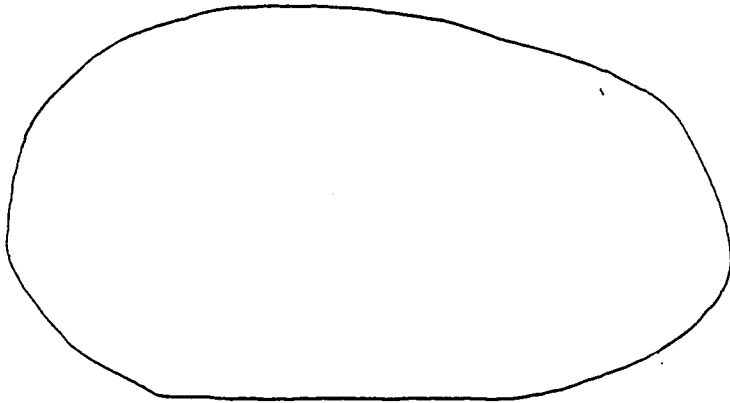
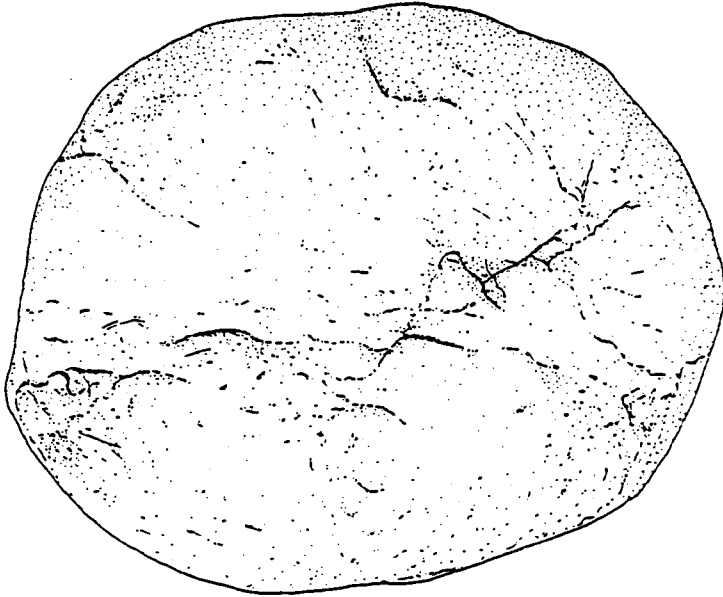



ANTA  
**III dos COURELEIROS**



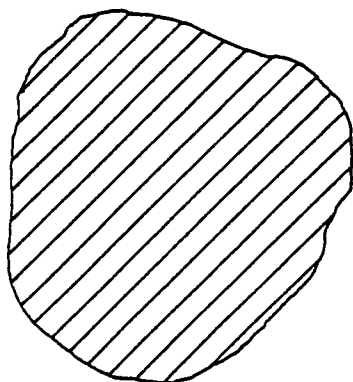
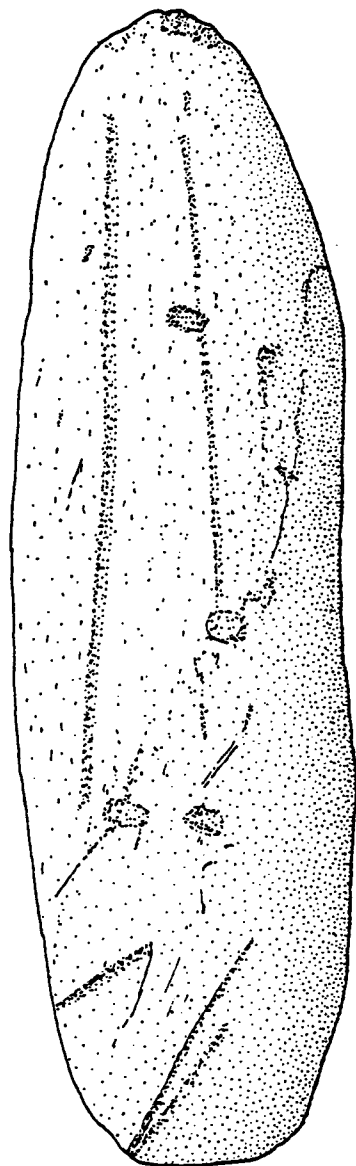
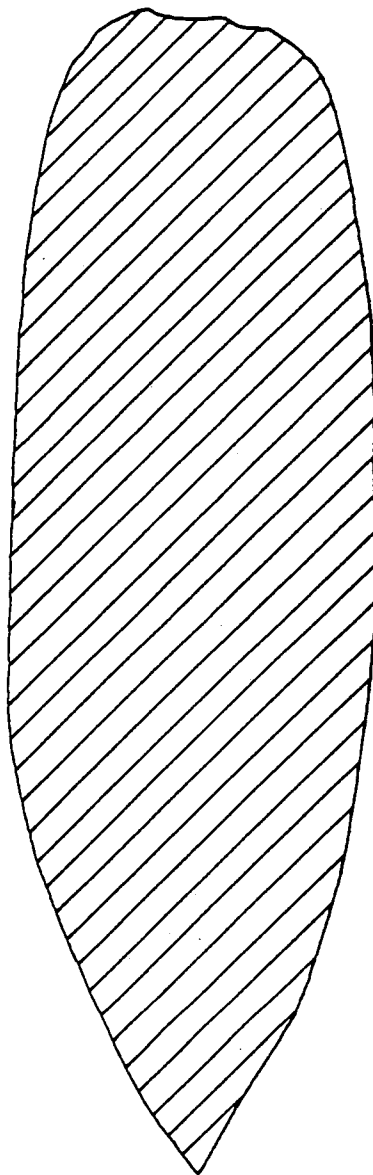

C III 9





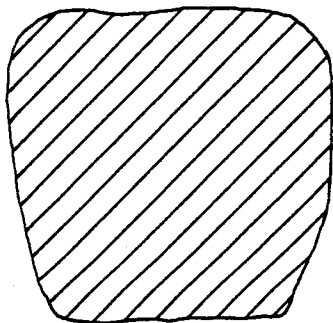
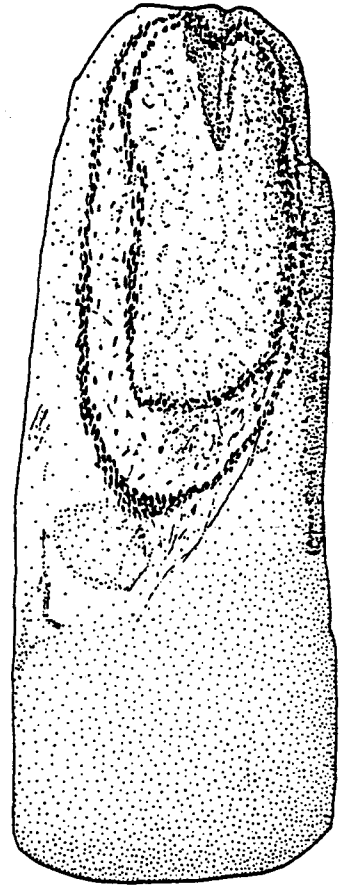
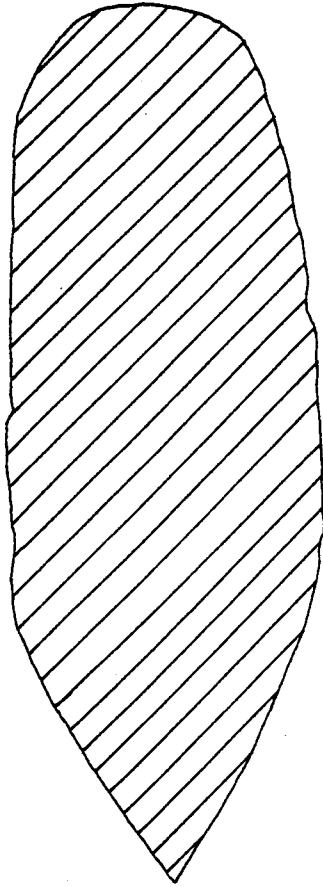
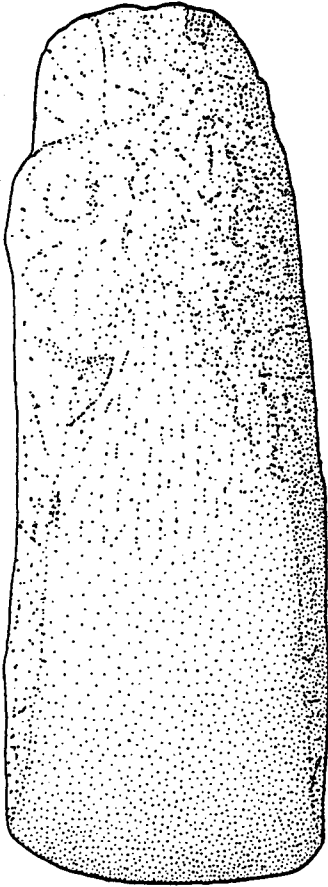

C III 1



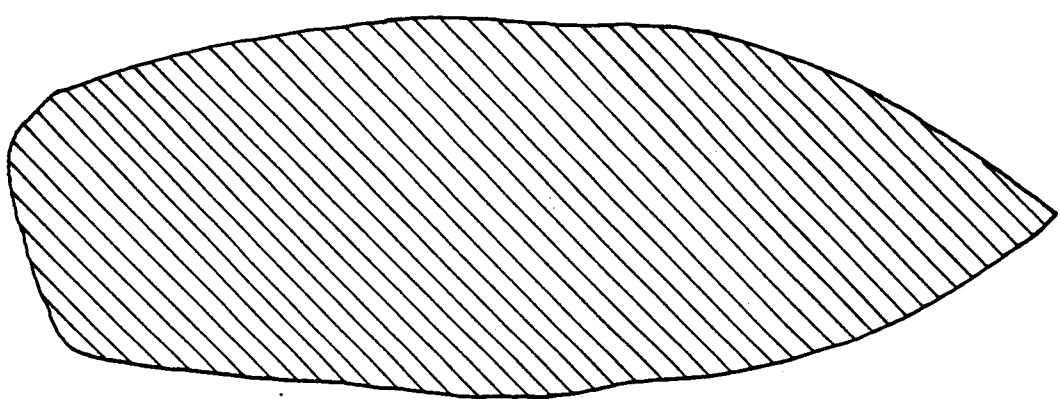
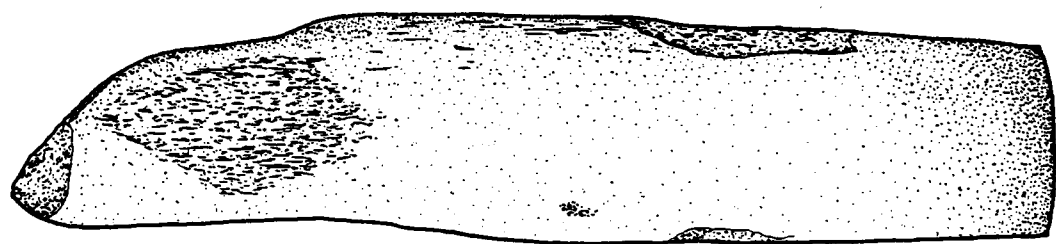

CIII 11

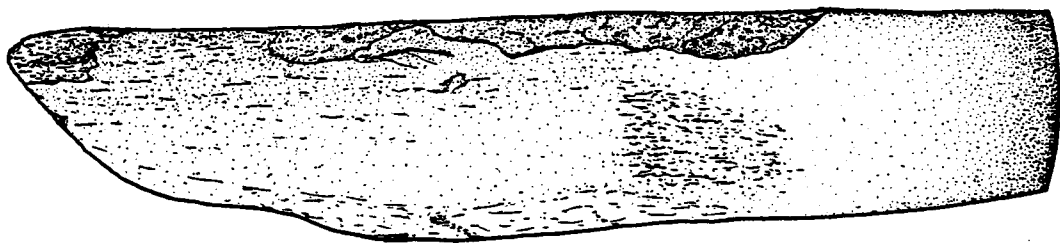

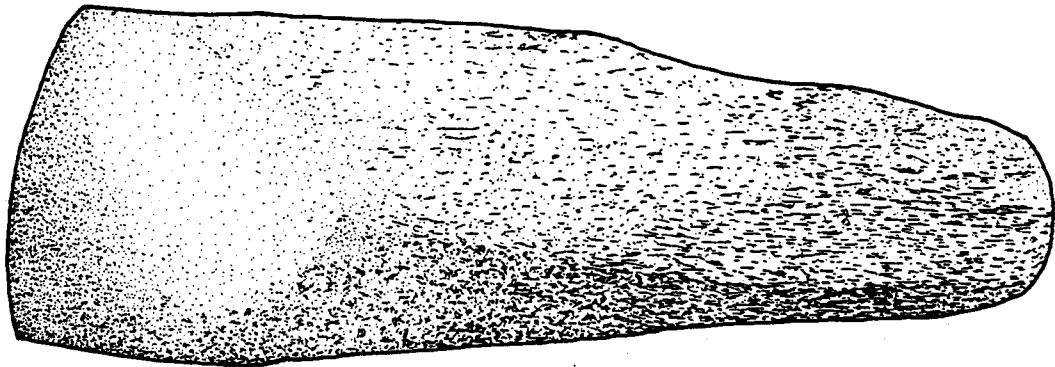
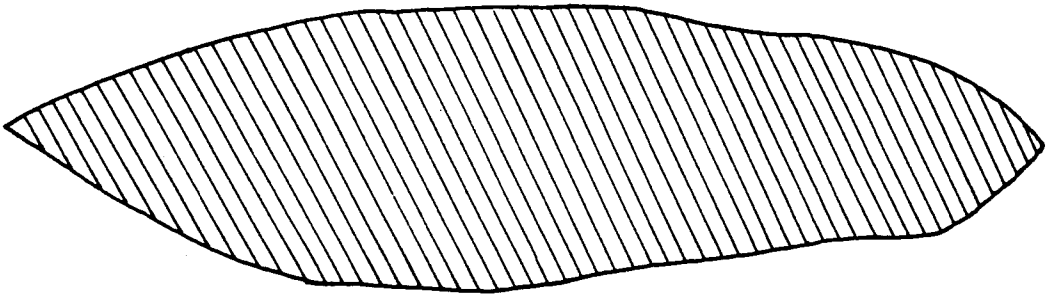
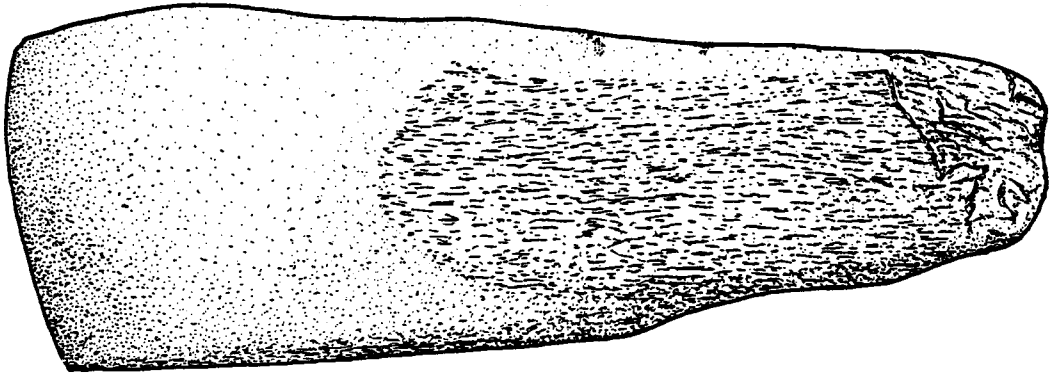

CHH 10



4cm

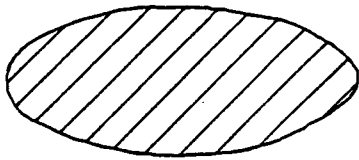
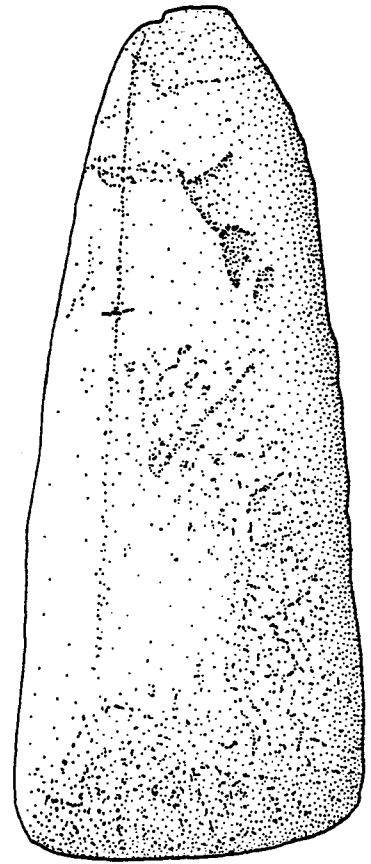
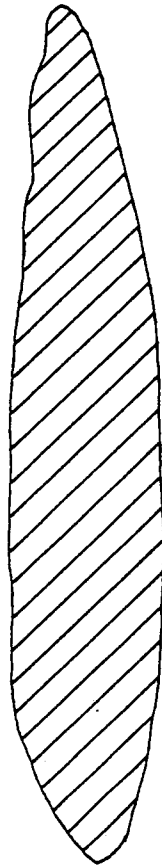
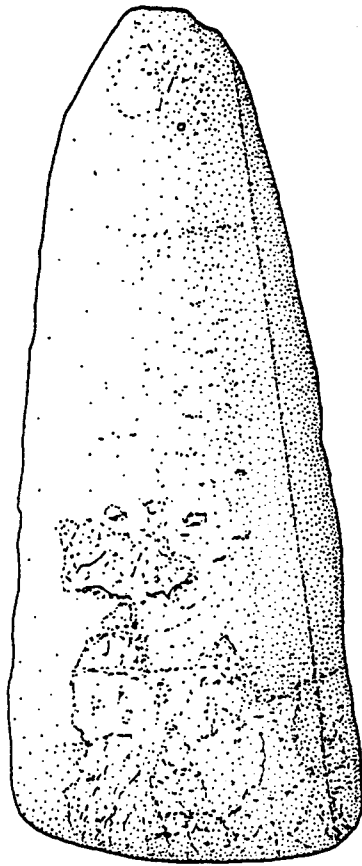

C III 14



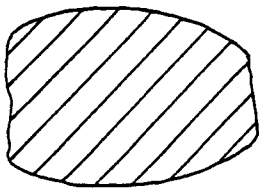
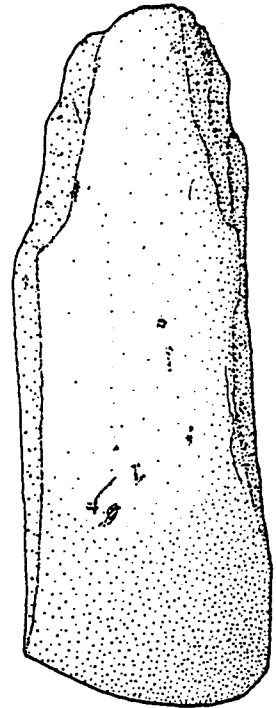
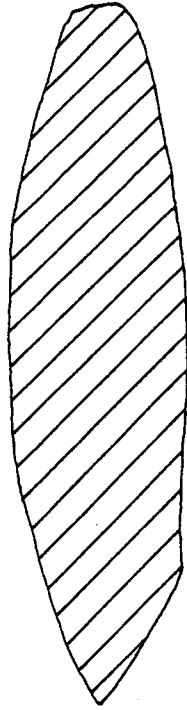
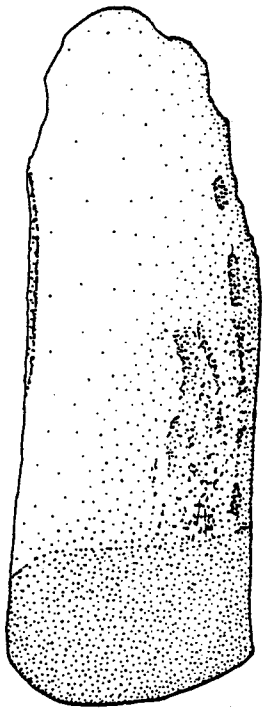

CIII 12



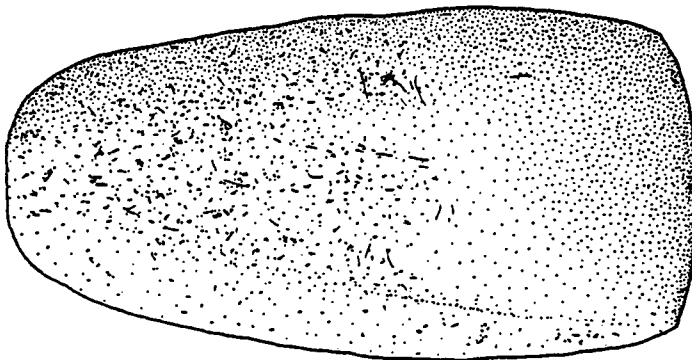
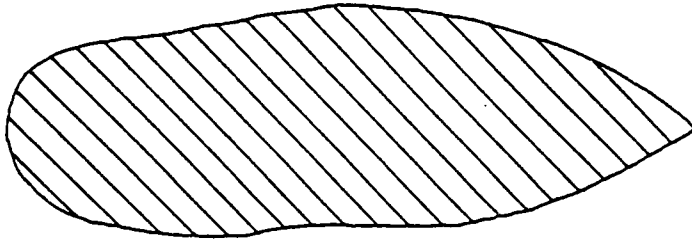
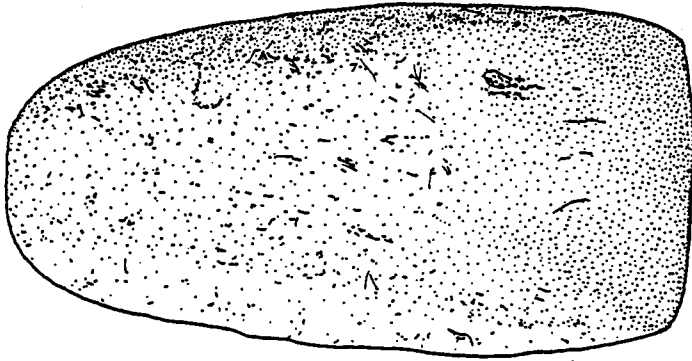

C III 16

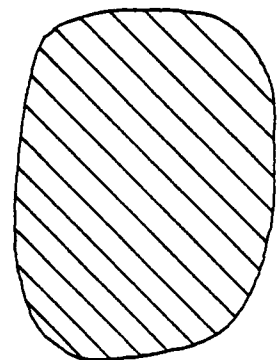

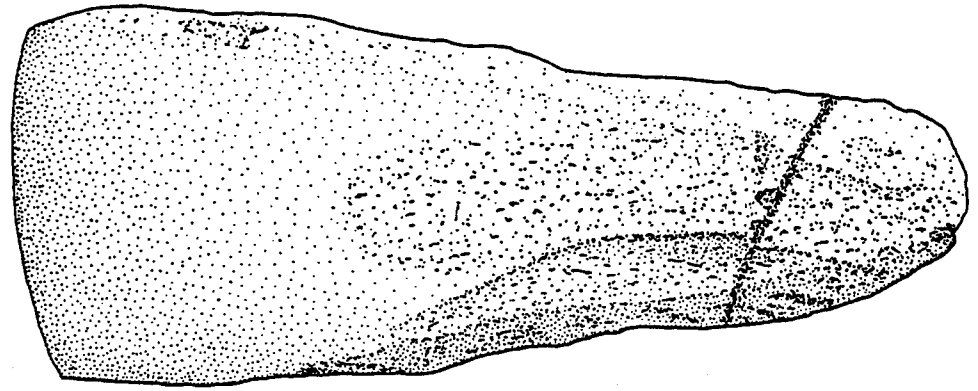
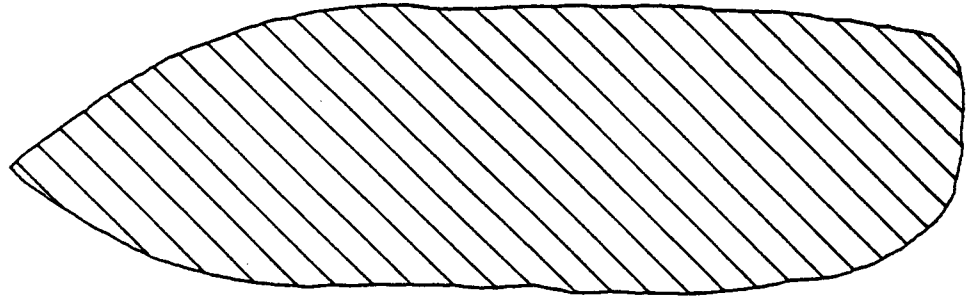
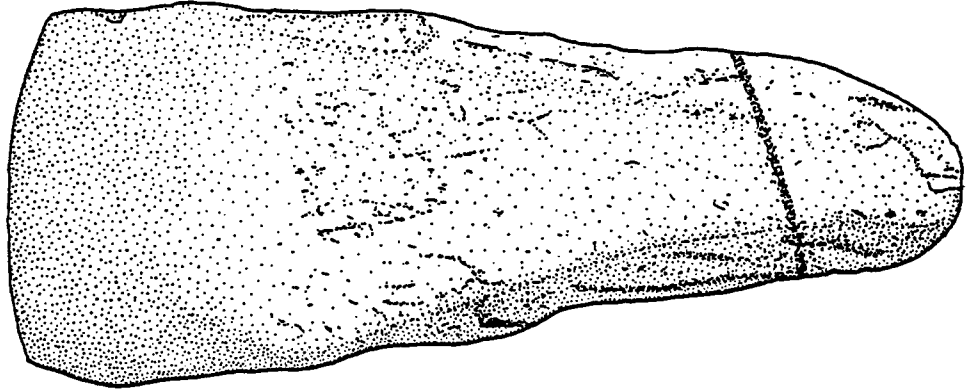
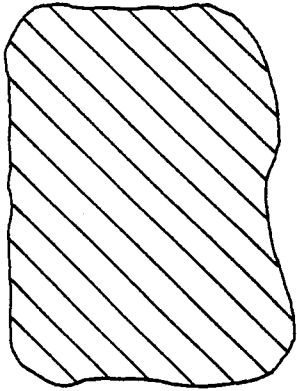

C III 15

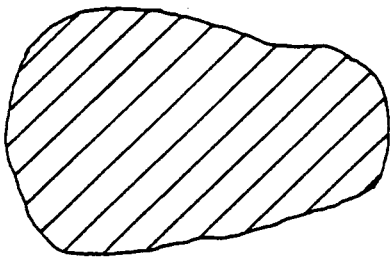
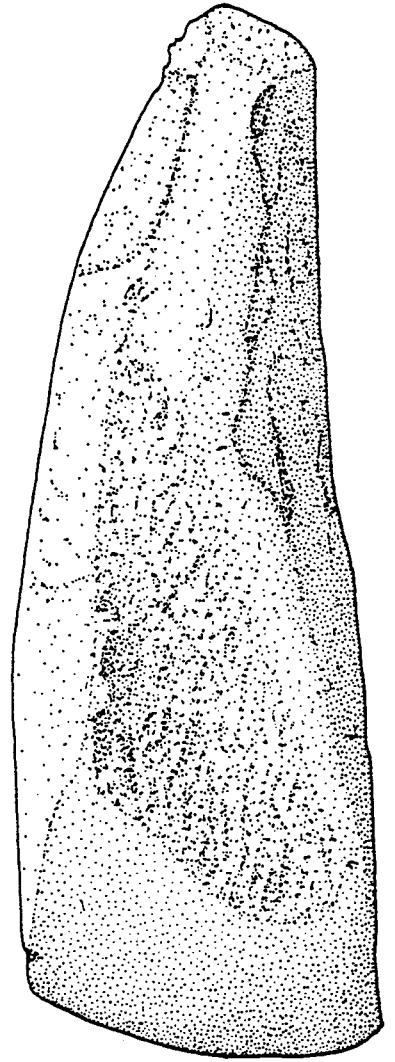
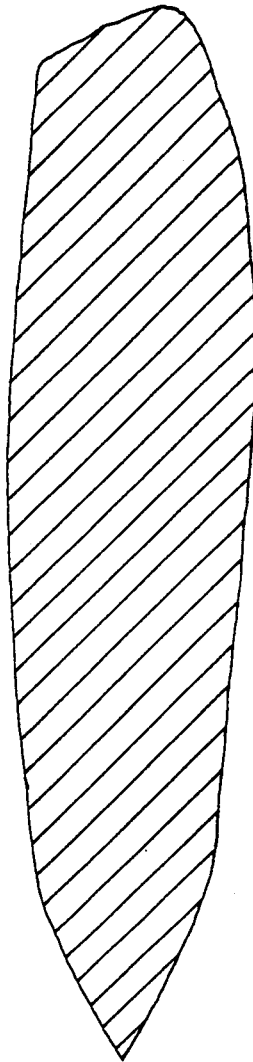
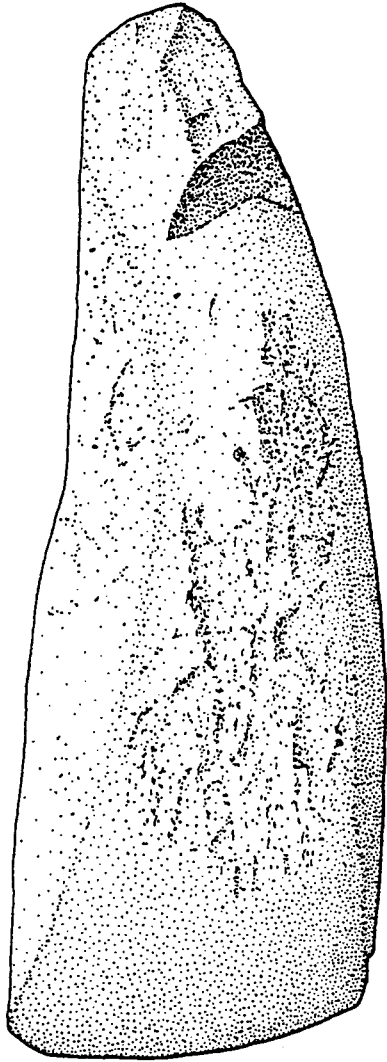

C III 18





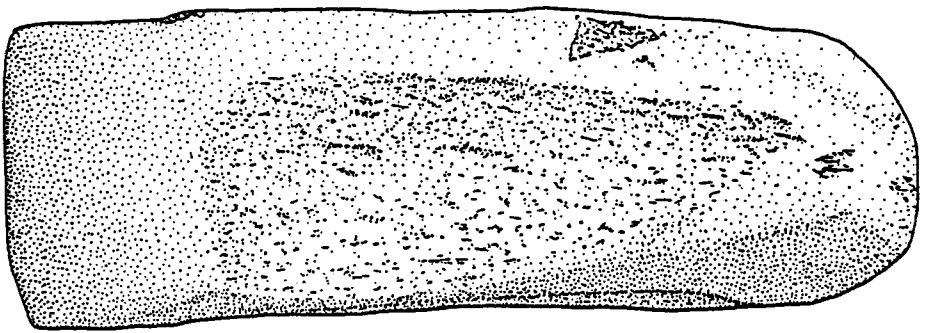
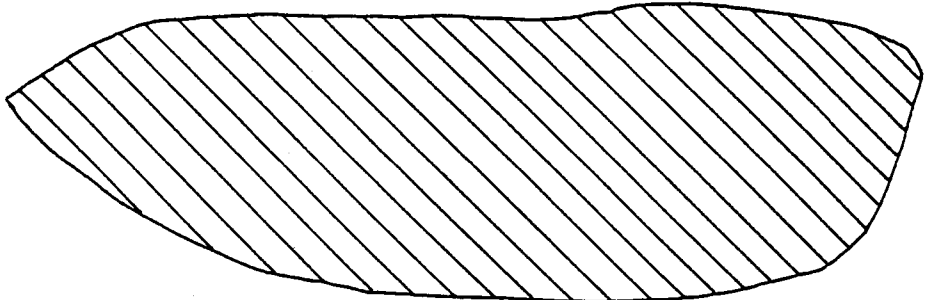
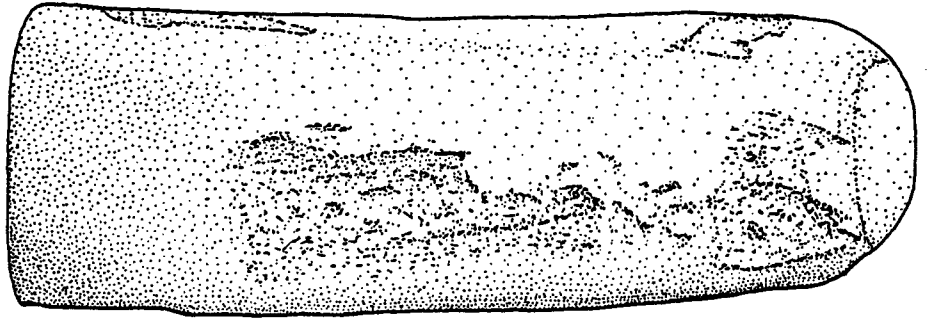
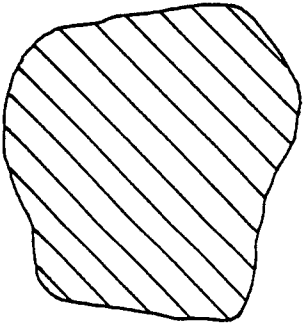

CHH 17

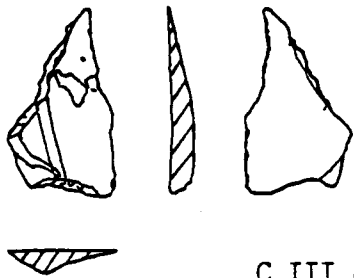

C III 8

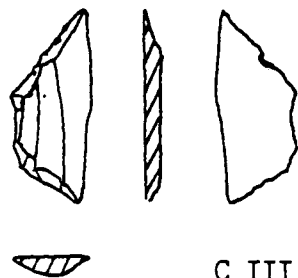

C III 20

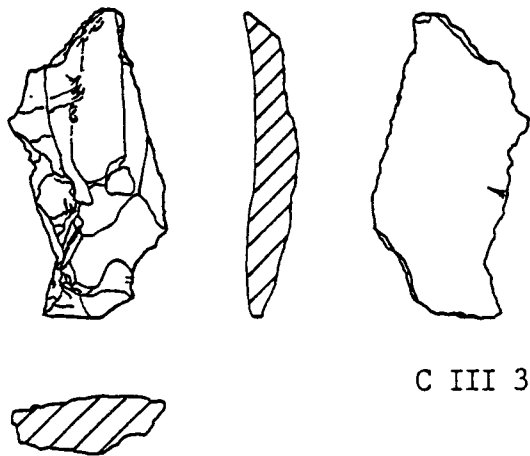

C III 3

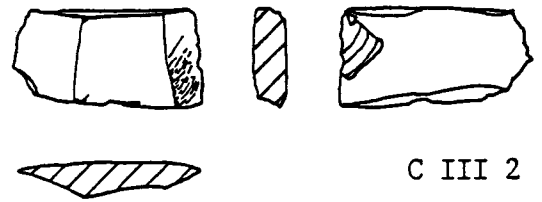

C III 2

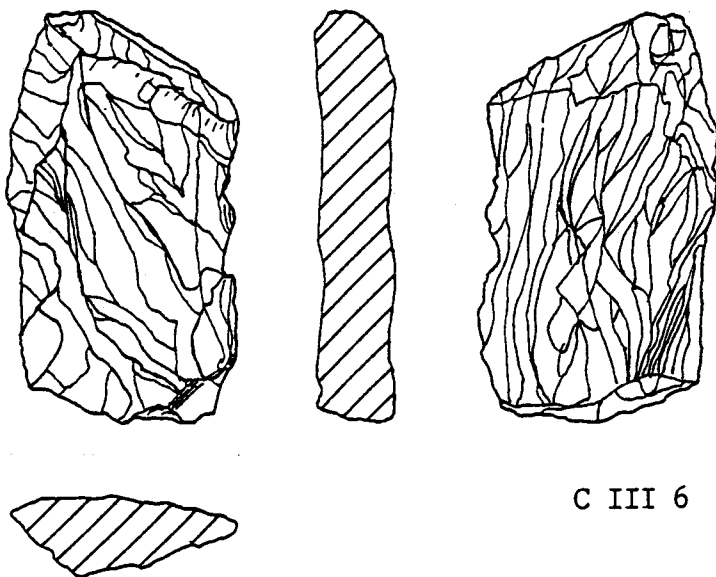

C III 6



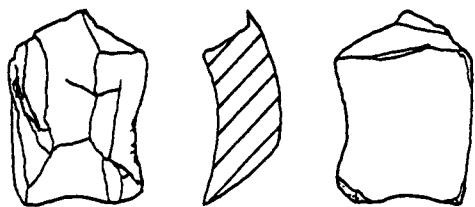

C III 24

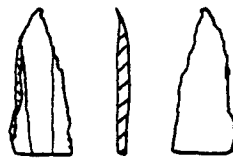

C III 19



C III 27



C III 26

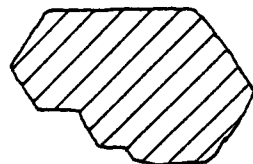
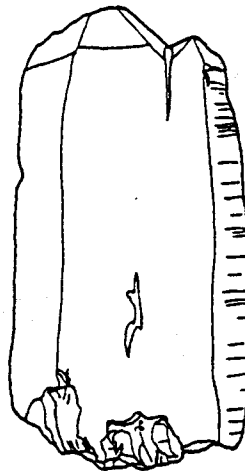
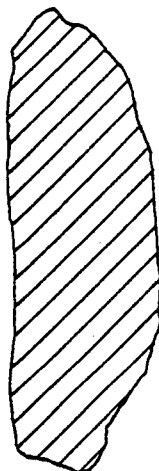

C III 25



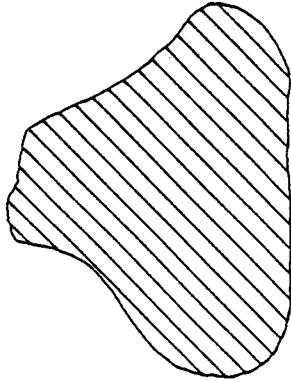

C III 28

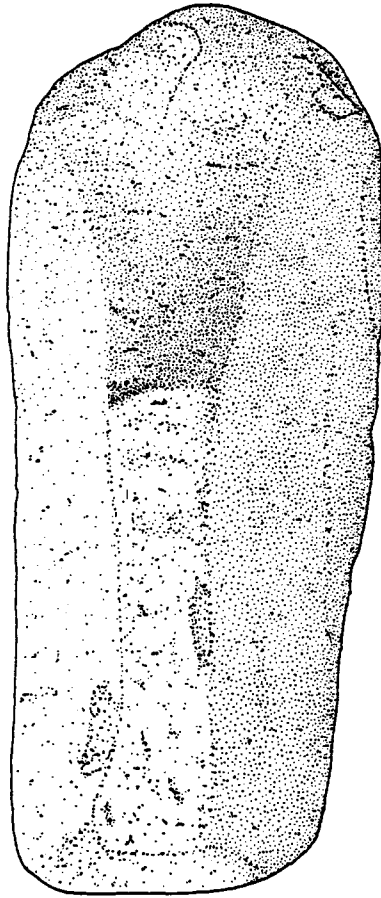
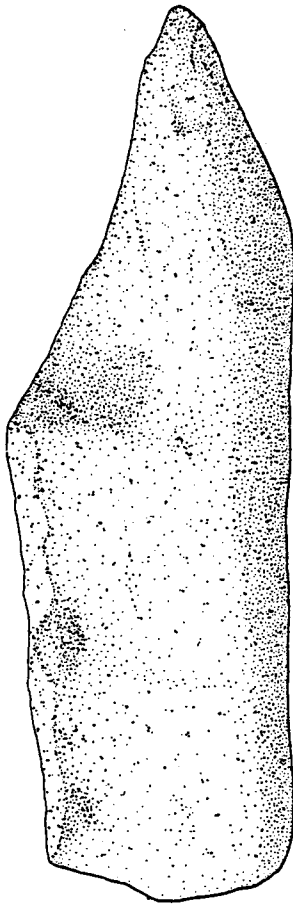

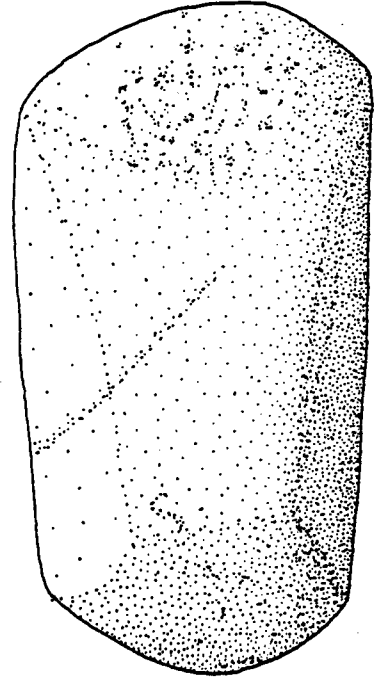
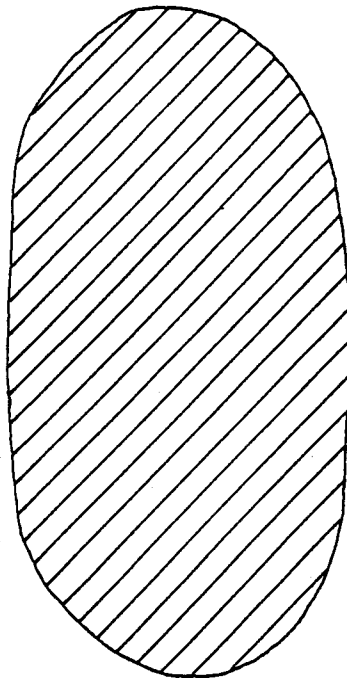
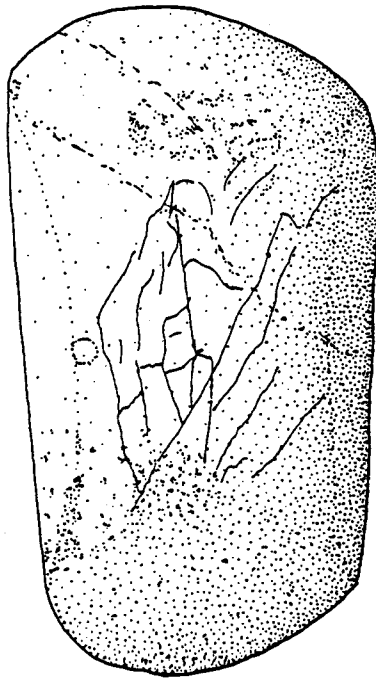
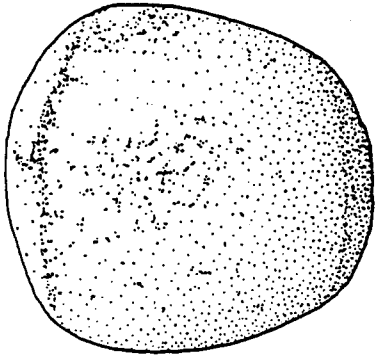

C III 13



ANTA  
**IV dos COURELEIROS**



CIV61

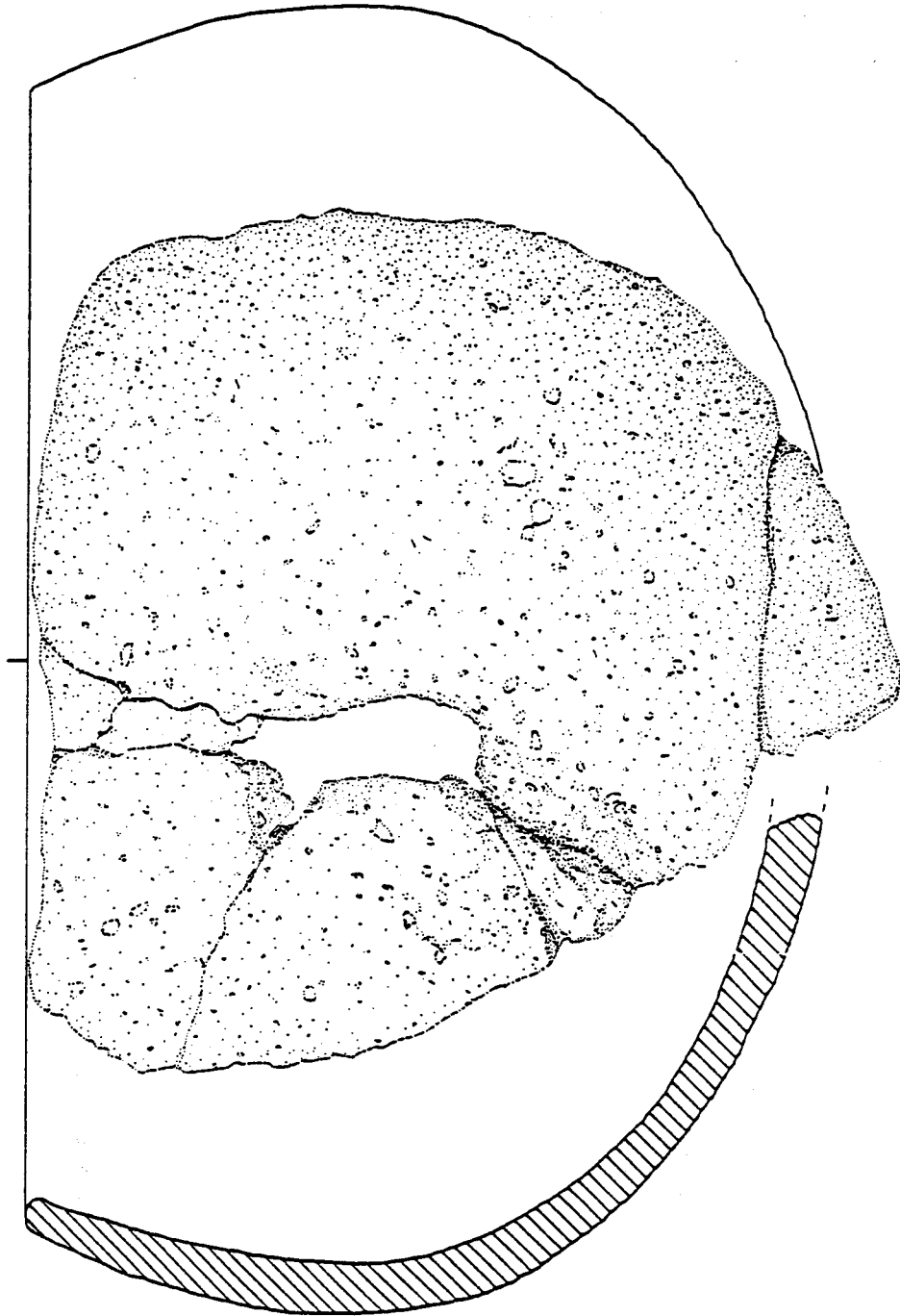



CIV57

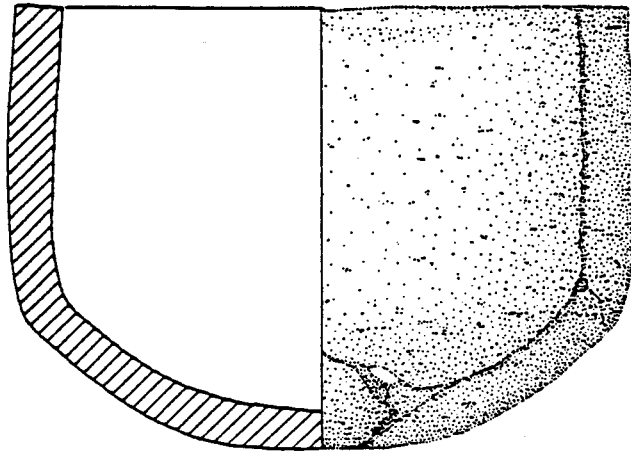

CIV59

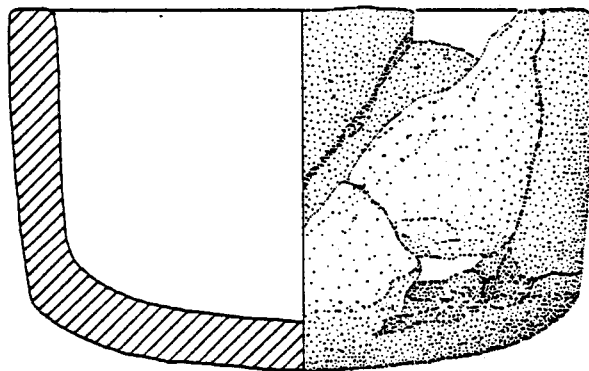

CIV63

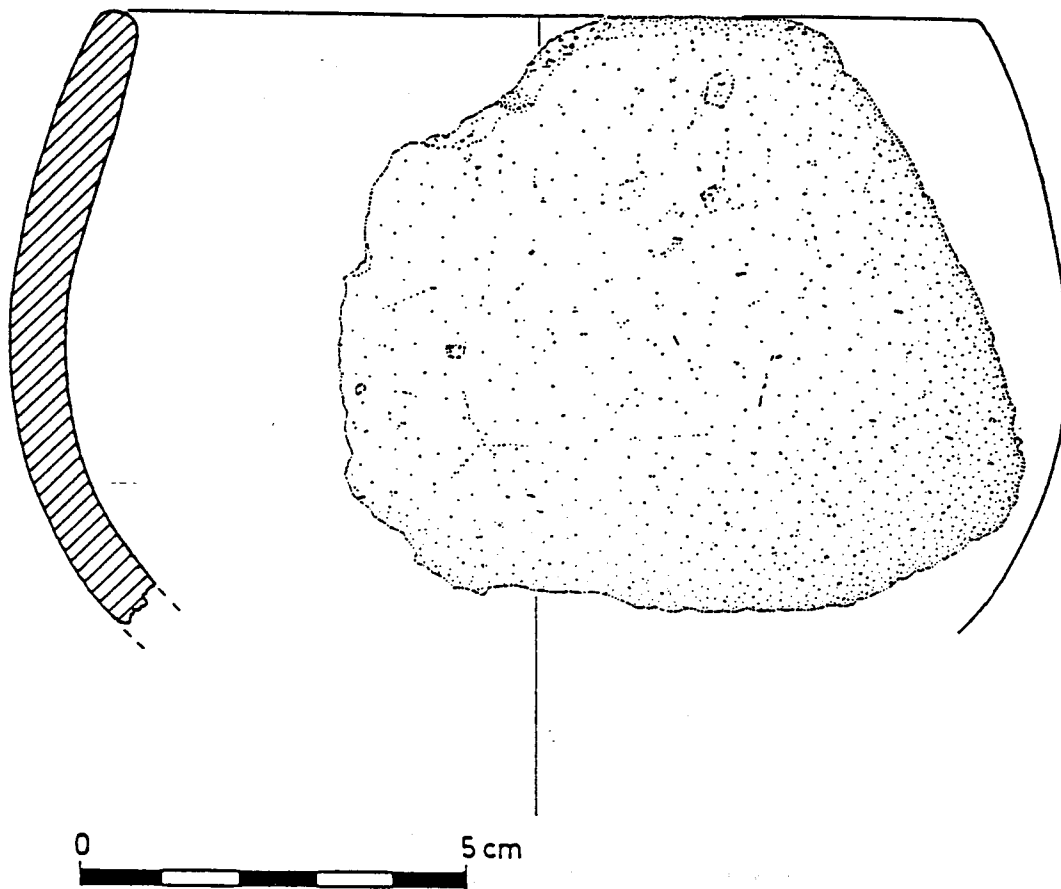

0  
5cm

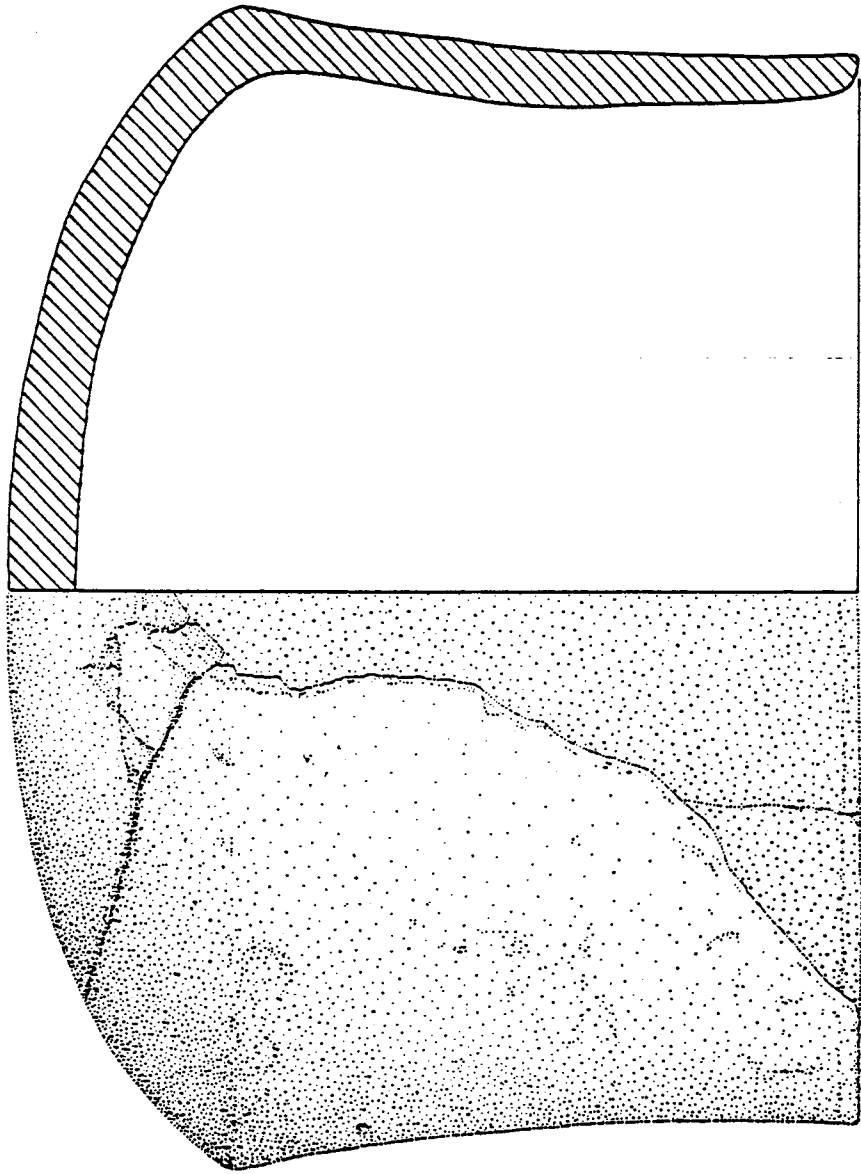

CIV60

CIV72

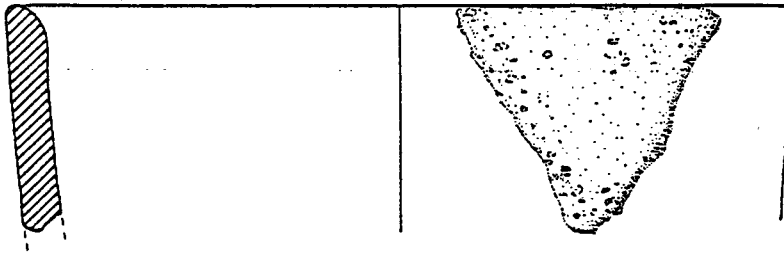

CIV66

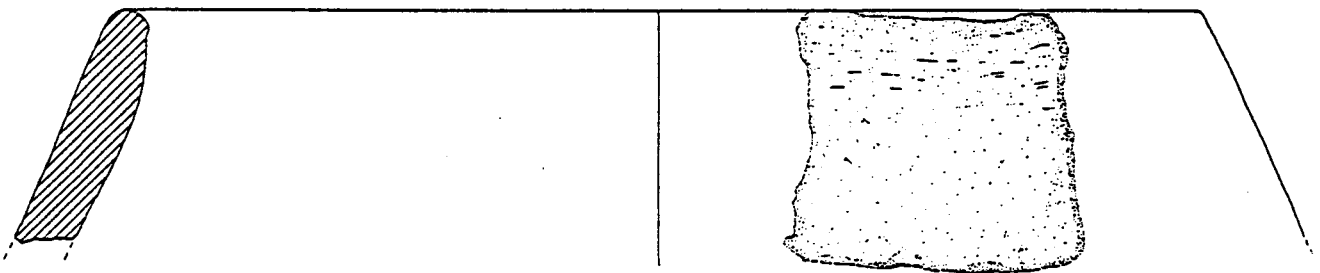

0 5 cm



CIV62

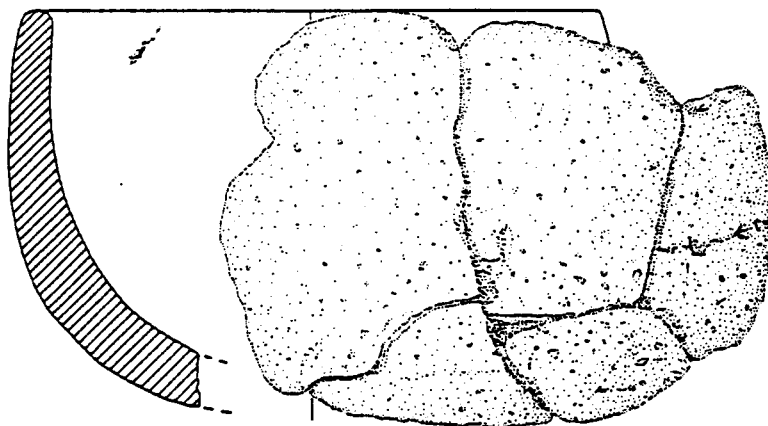

CIV64

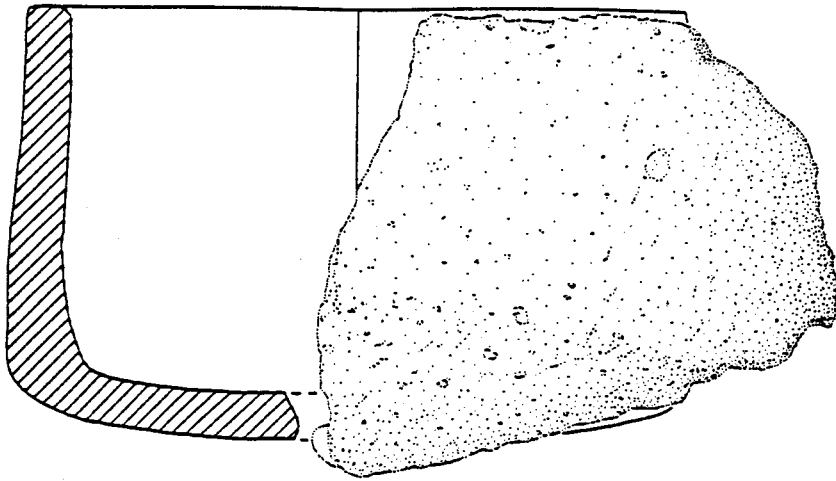

CIV65



CIV58

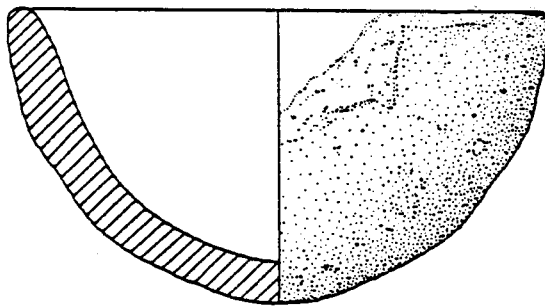

CIV70

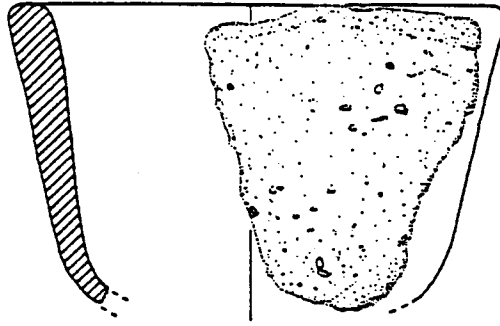

CIV73

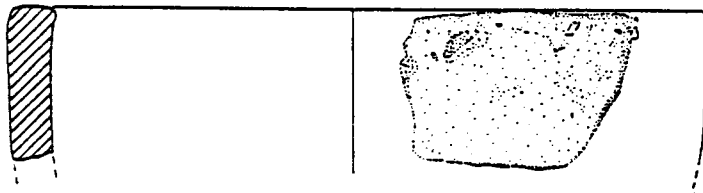

CIV67

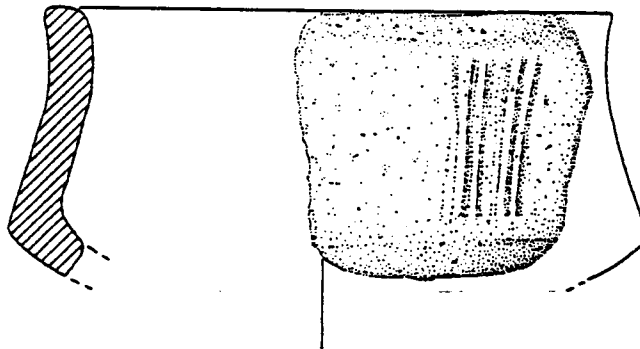

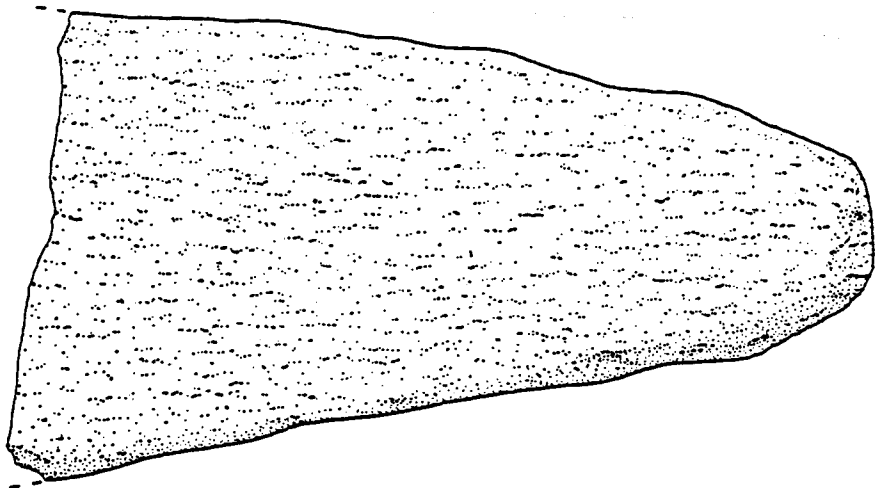
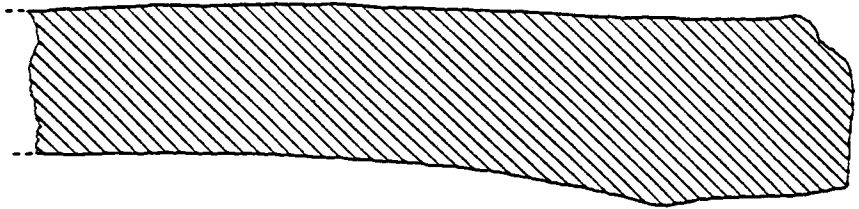
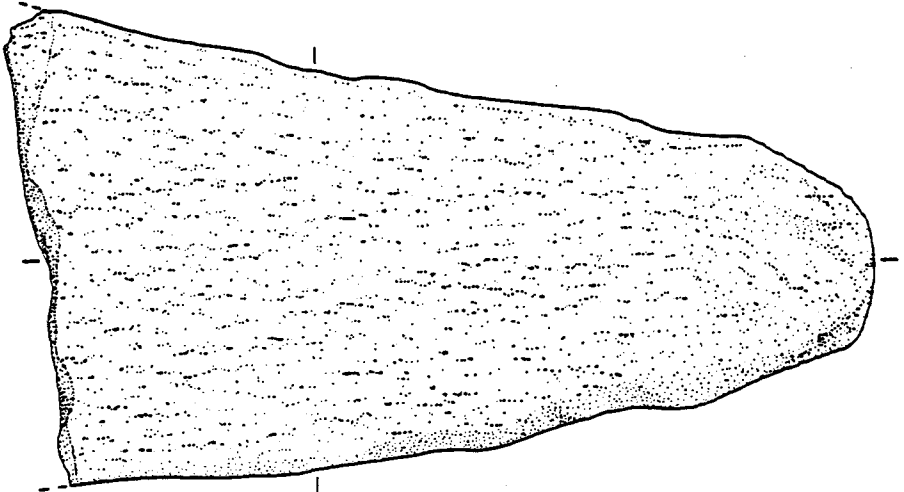
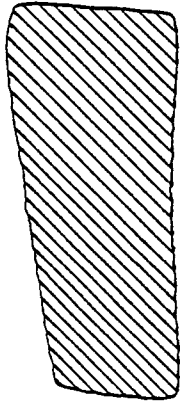

CIV77

CIV20

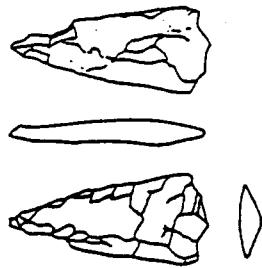

CIV23

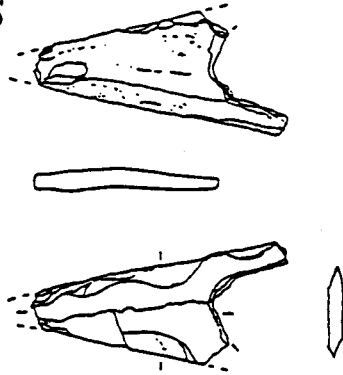

CIV26

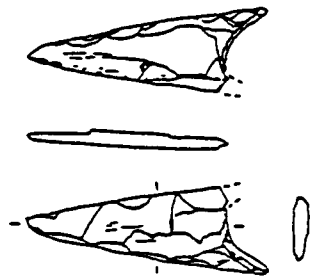

CIV29

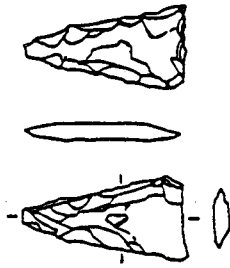

CIV21

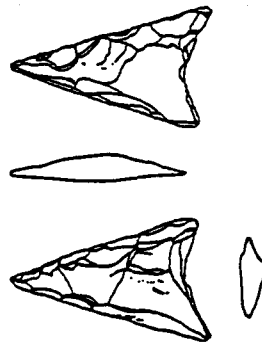

CIV24

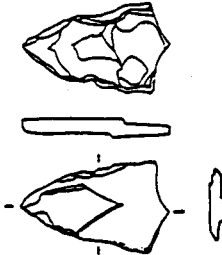

CIV27

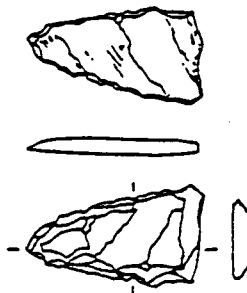

CIV30

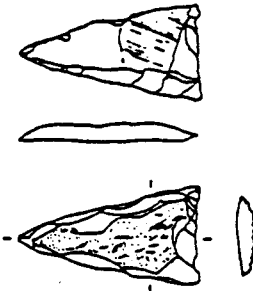

CIV22

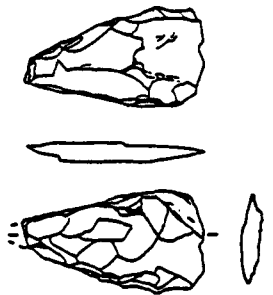

CIV25

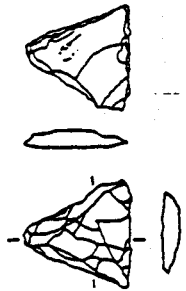

CIV28

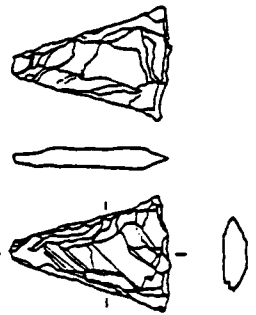

CIV31

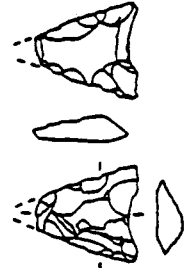



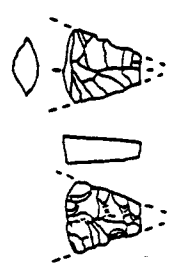

CIV32

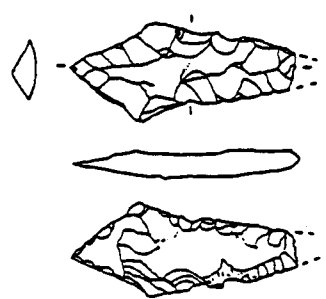

CIV35

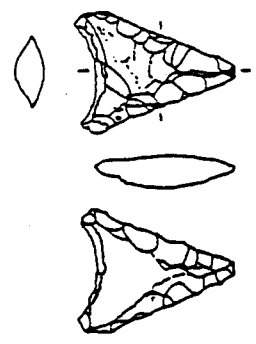

CIV38

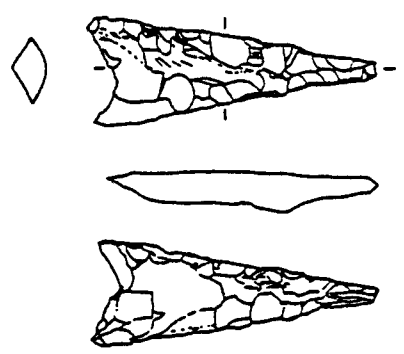

CIV41

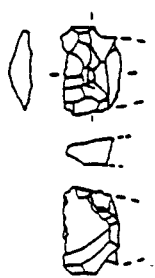

CIV33

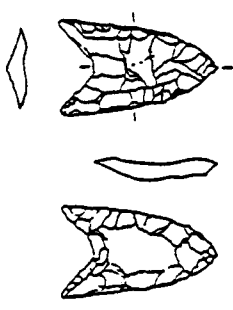

CIV36

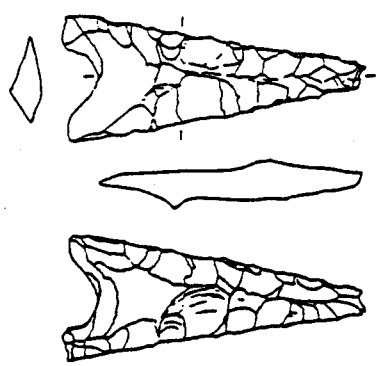

CIV39

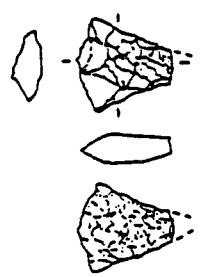

CIV42

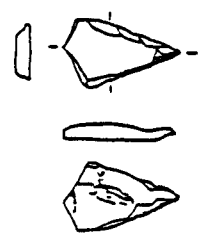

CIV34

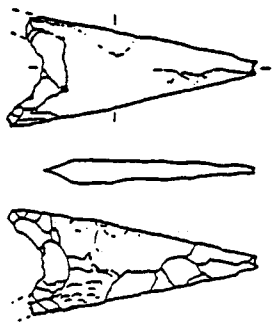

CIV37

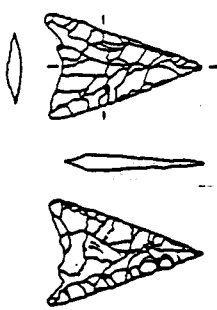

CIV40

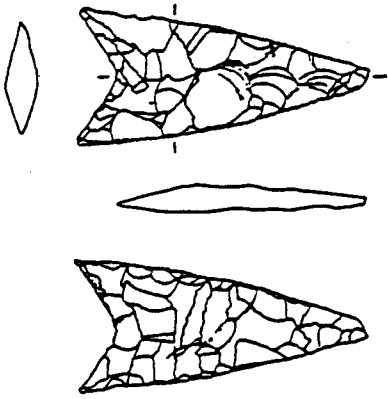

CIV43



CIV2

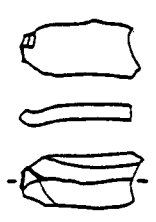

CIV1

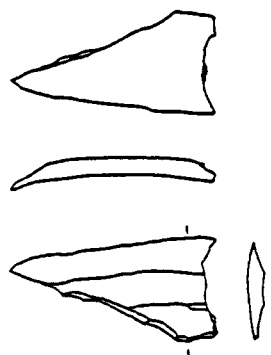

CIV47

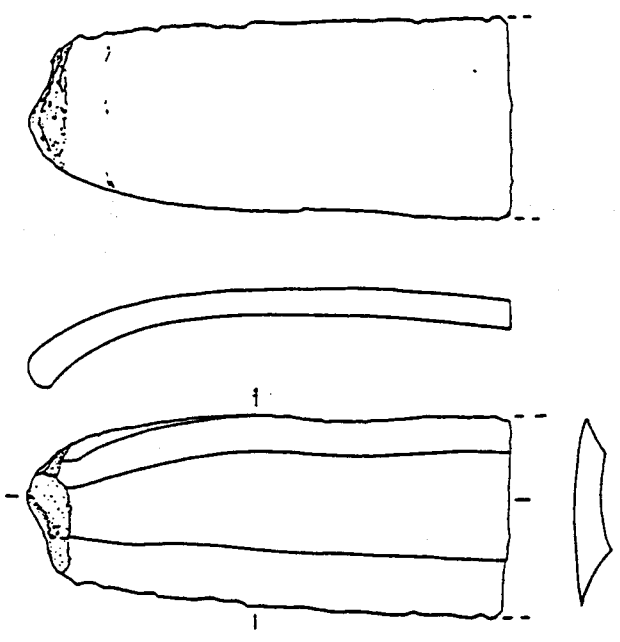

CIV49

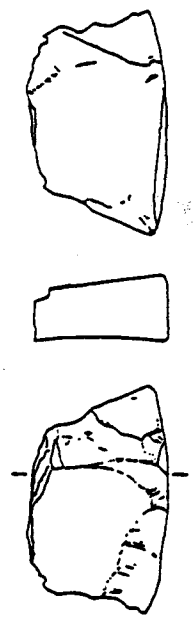

CIV44

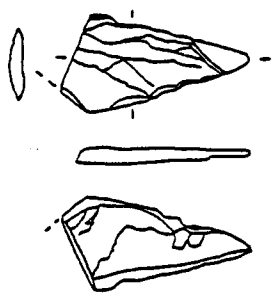

CIV45

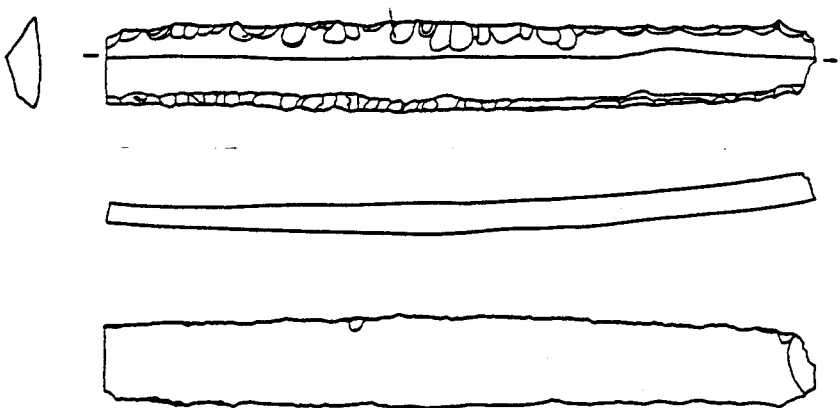

CIV46

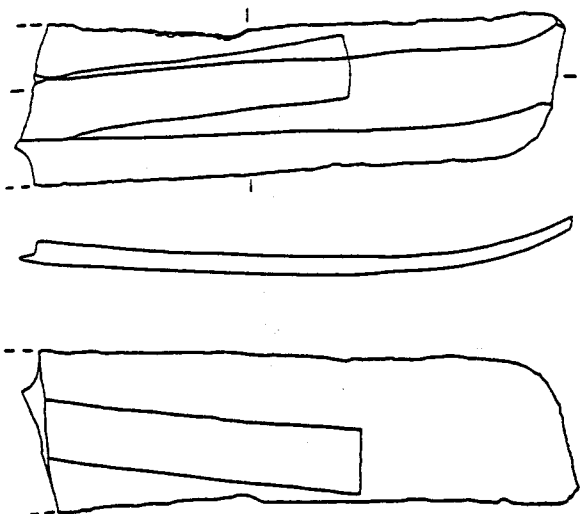

CIV48

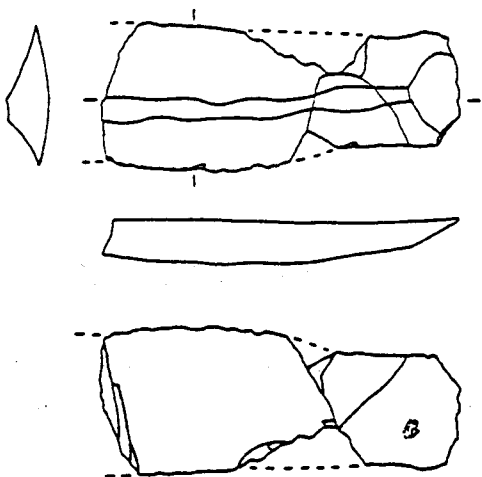
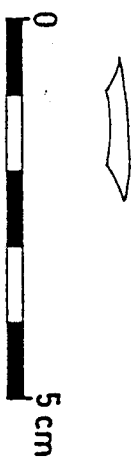

CIV52

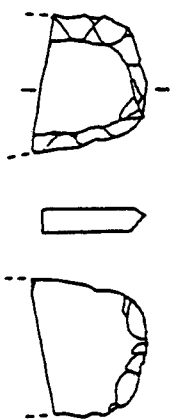

CIV50

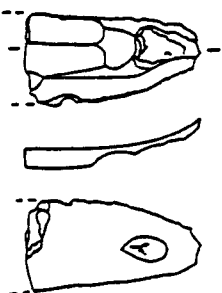

CIV51

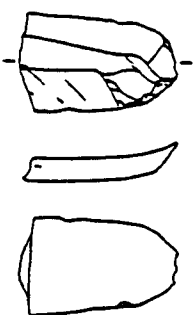

CIV54

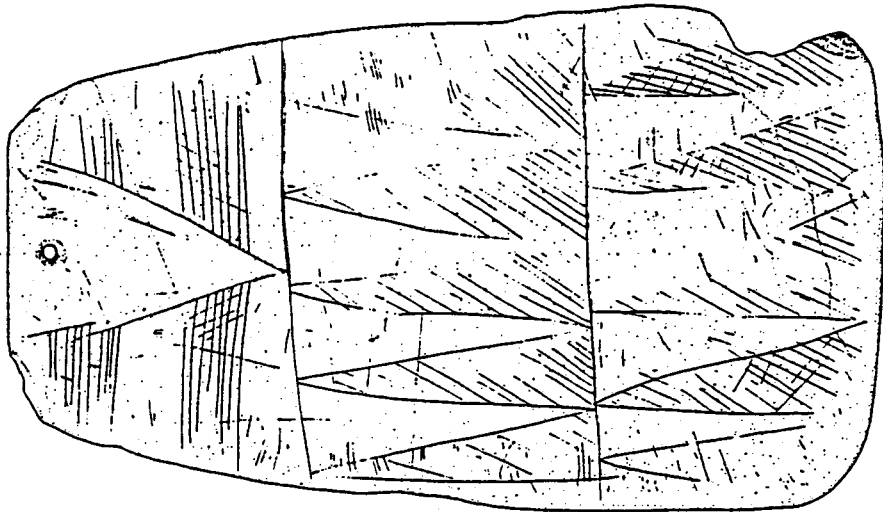
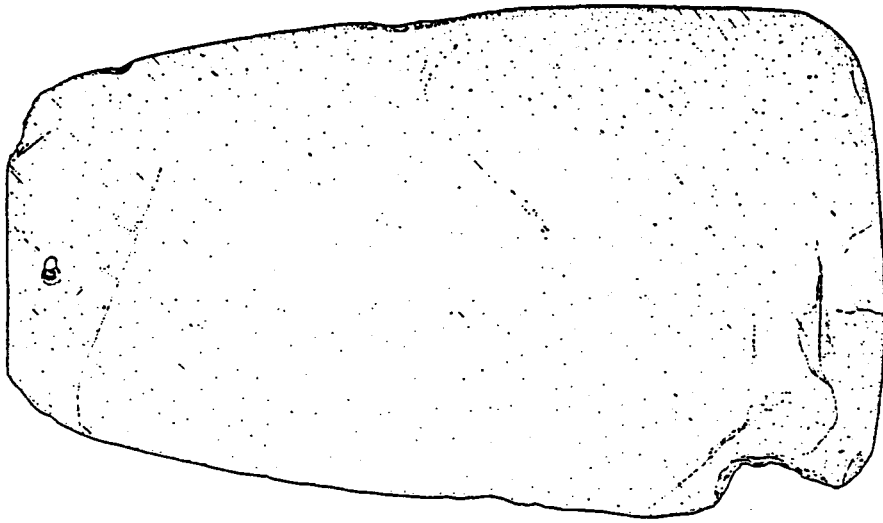

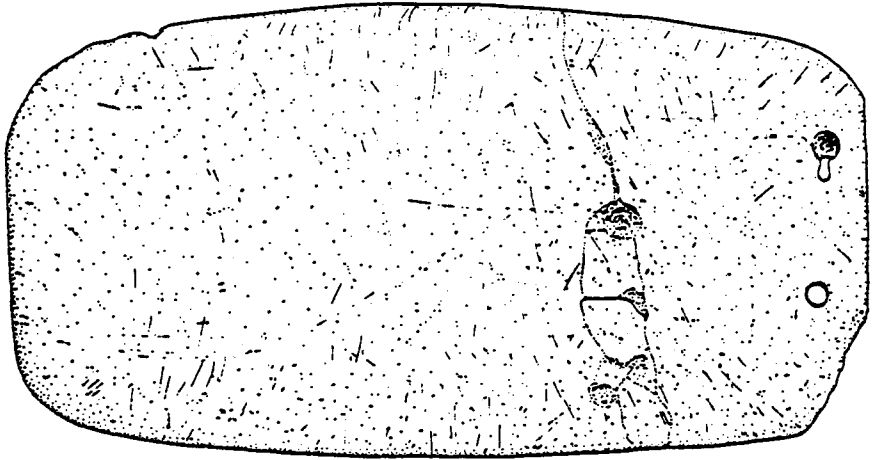
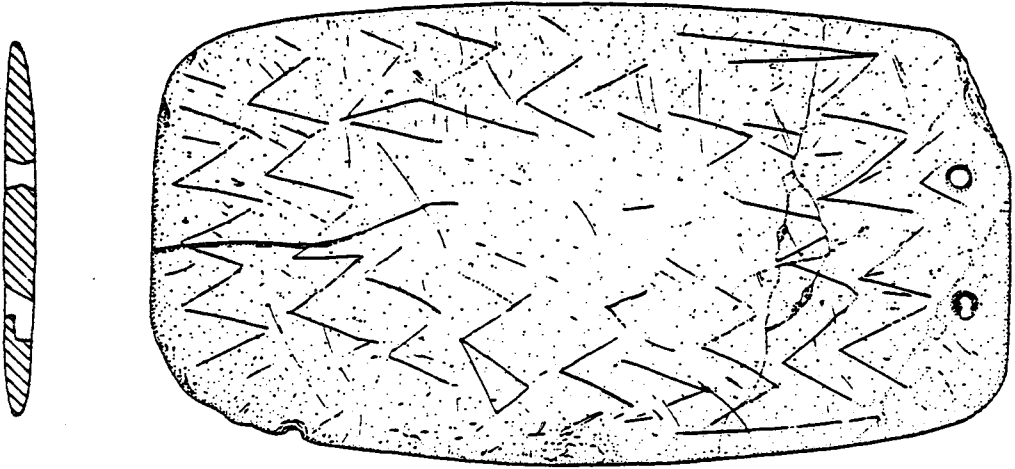

CIV 56

CIV 55

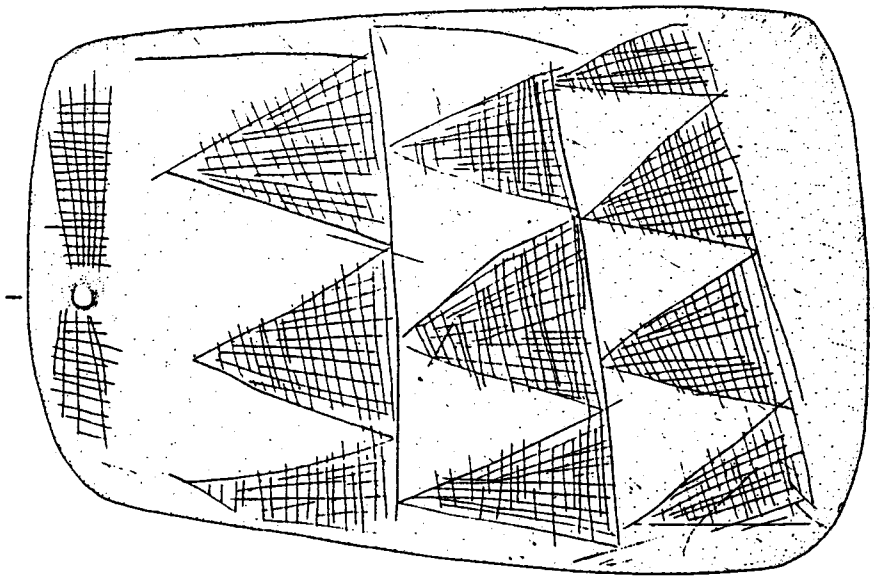
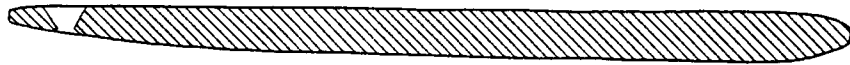
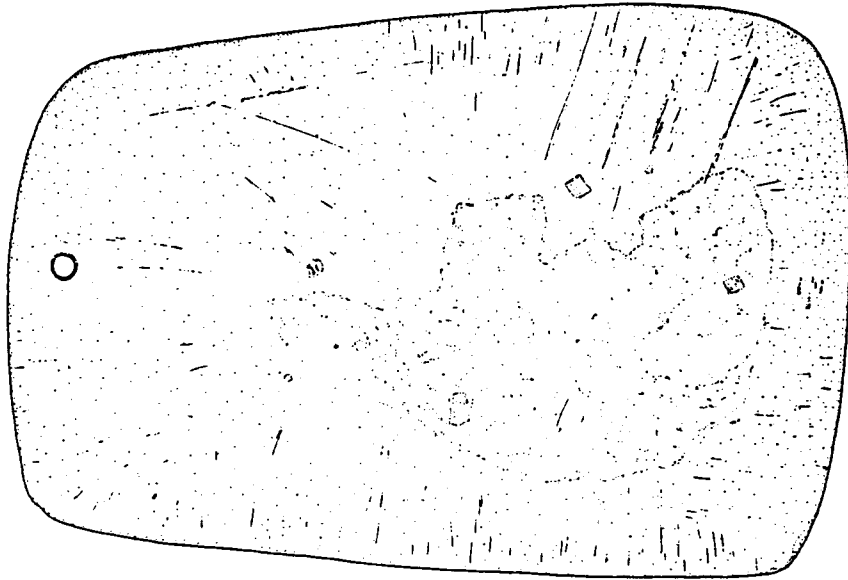

CIV53

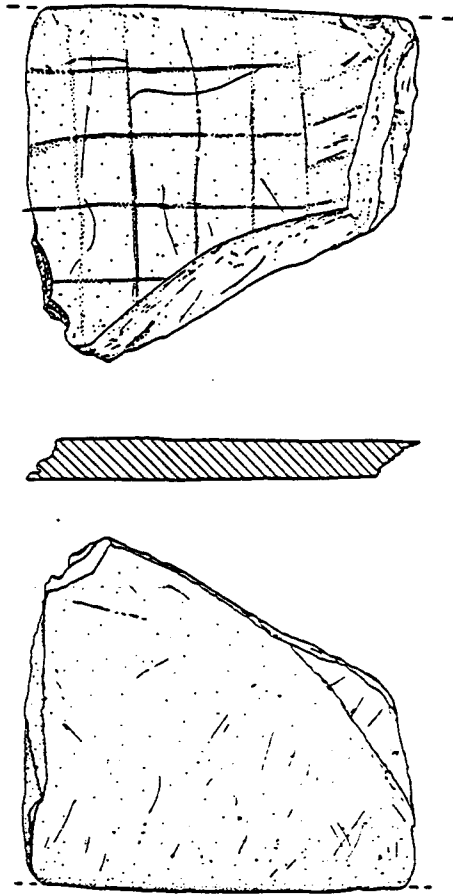

CIV53

CIV 5



CIV 11



CIV 10



CIV 8

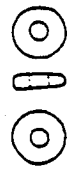

CIV 16

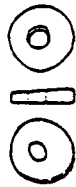

CIV 7

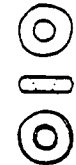

CIV 18

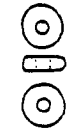

CIV 9

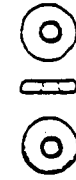

CIV 13

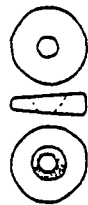

CIV 19



CIV 3

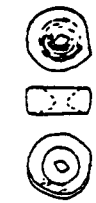

CIV 4



CIV 15

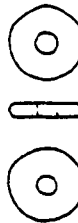

CIV 17



CIV 12



CIV 14

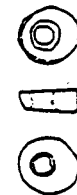

CIV 6







ANTA  
do  
**GALHARDO**



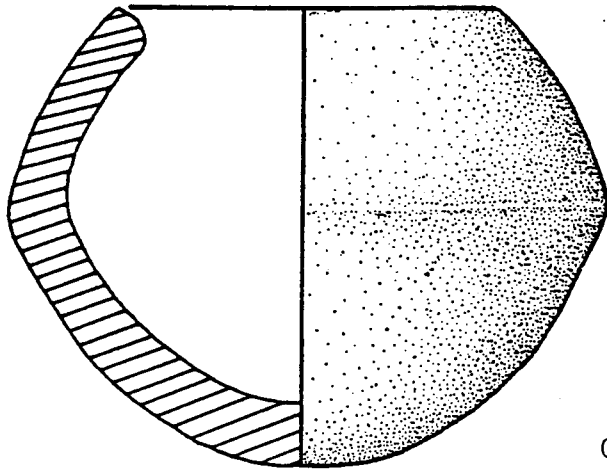

G 8

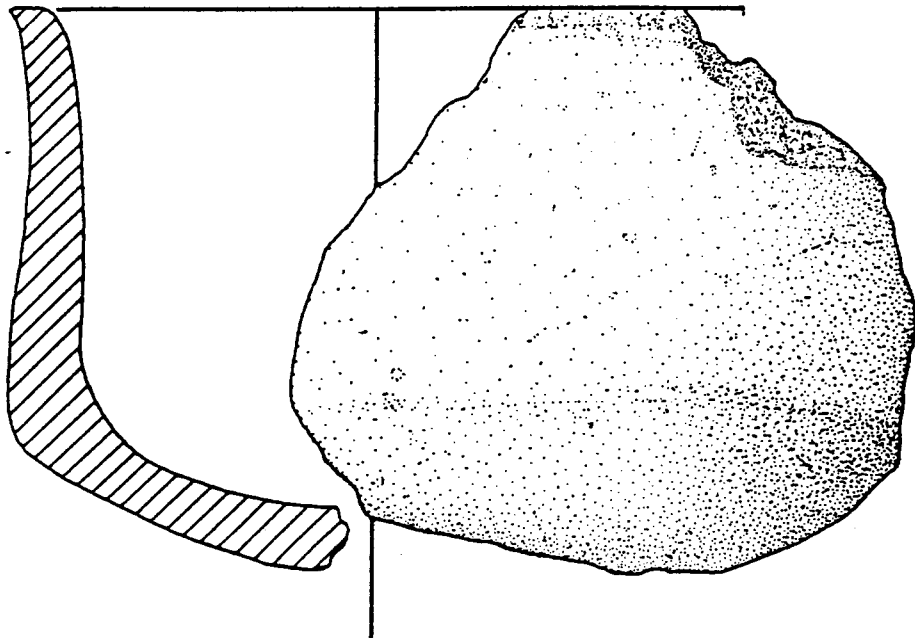

G 7



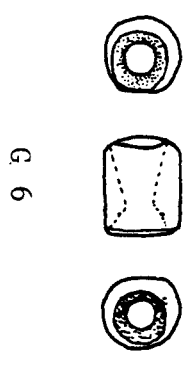
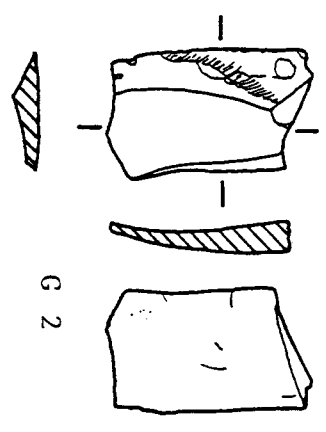
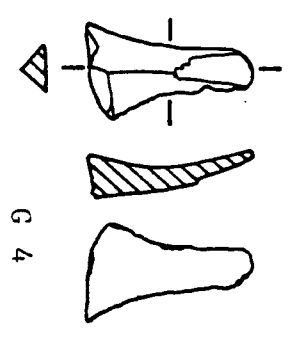
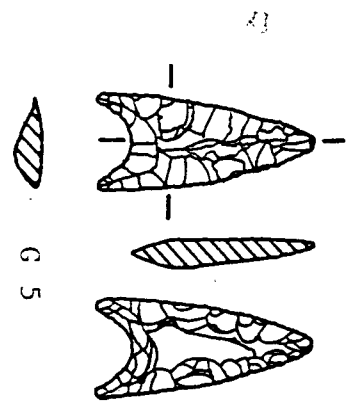
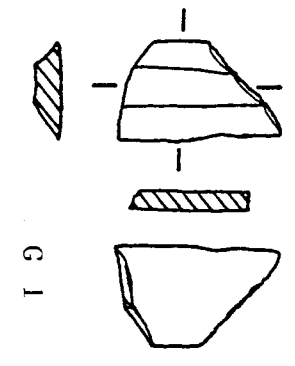
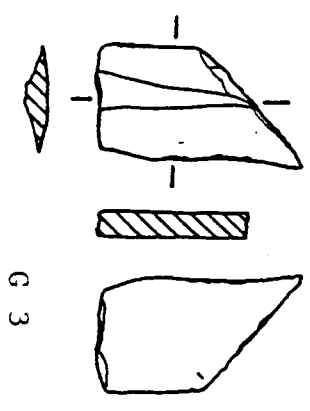

ANTA  
dos  
**OLHEIROS**



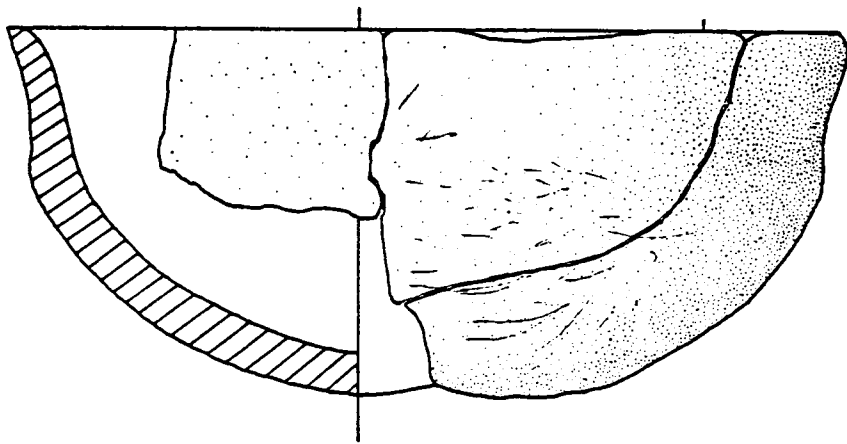

0 12





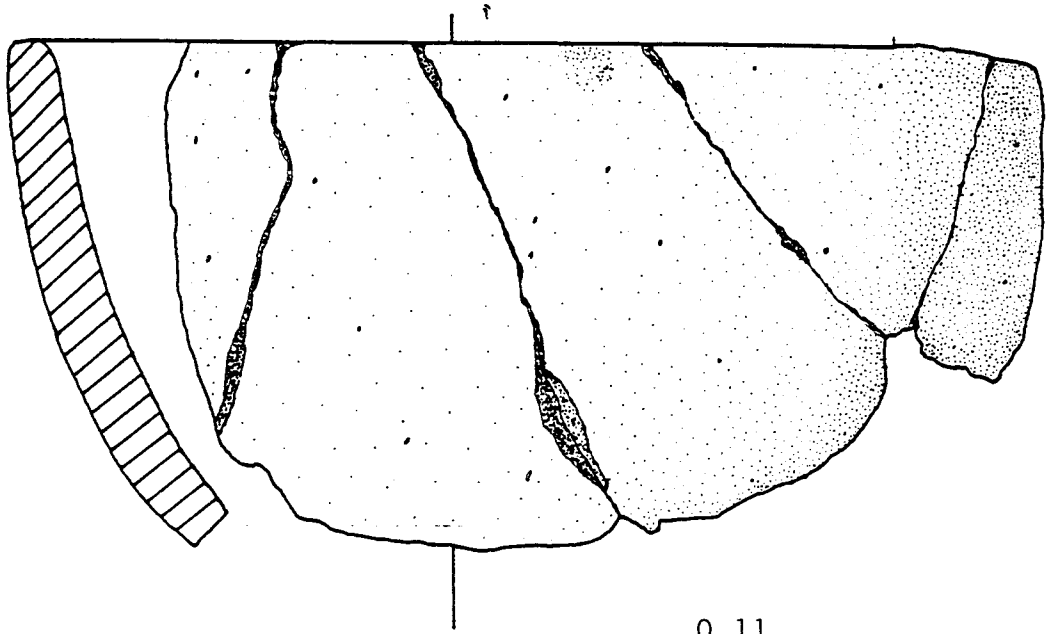

O 11

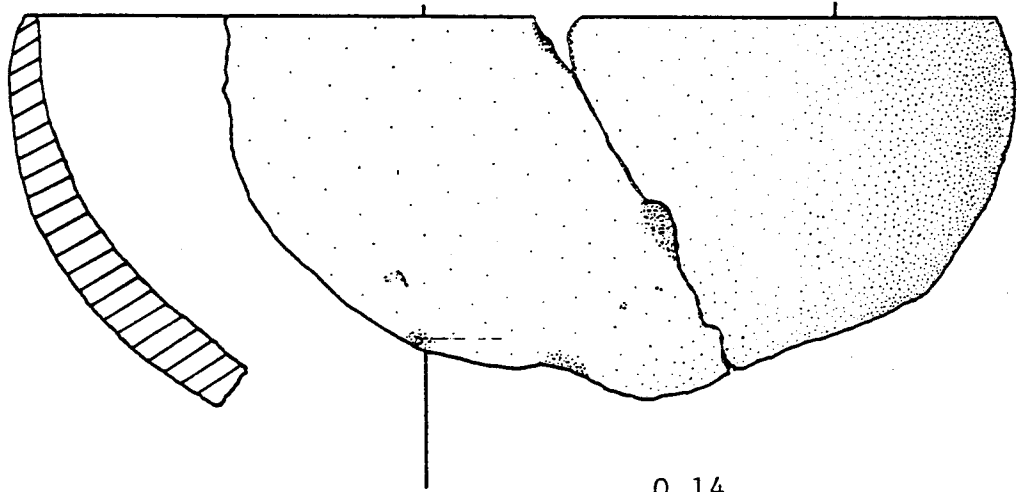

O 14



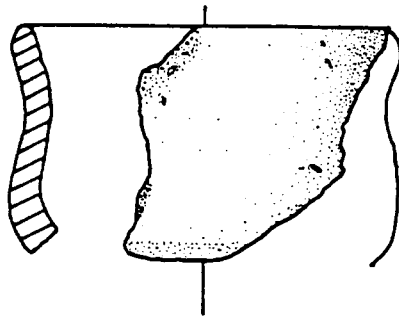

0 25

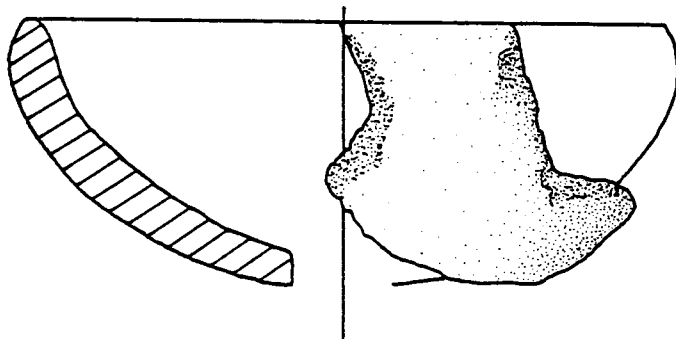

0 17

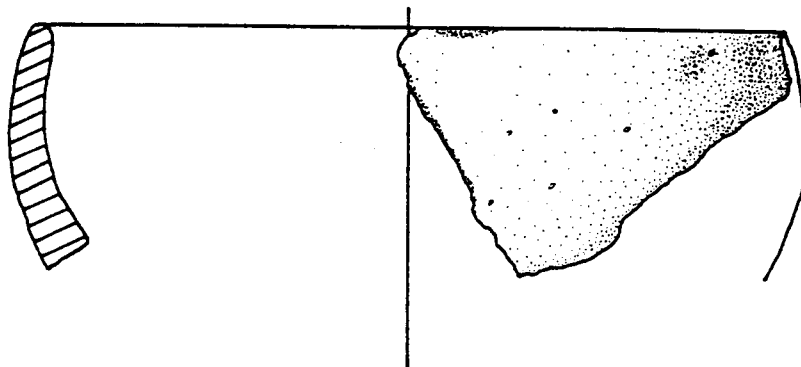

0 13



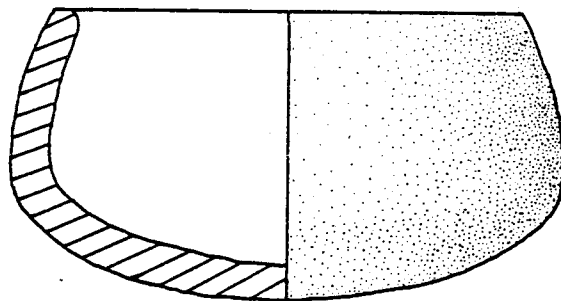
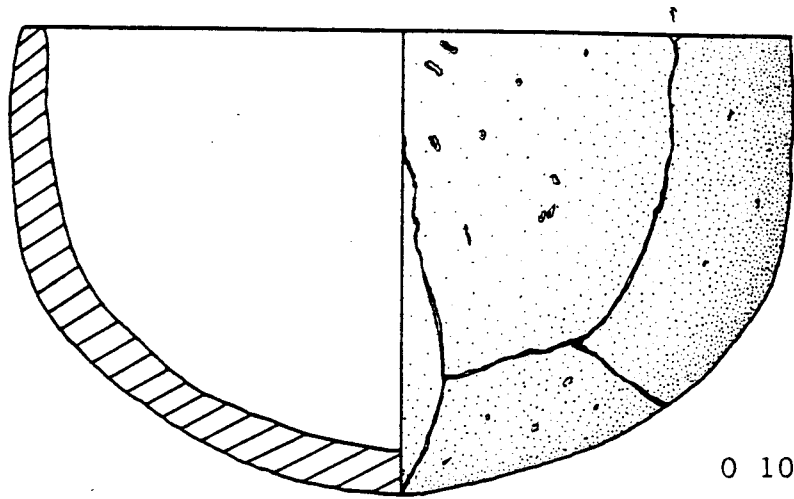

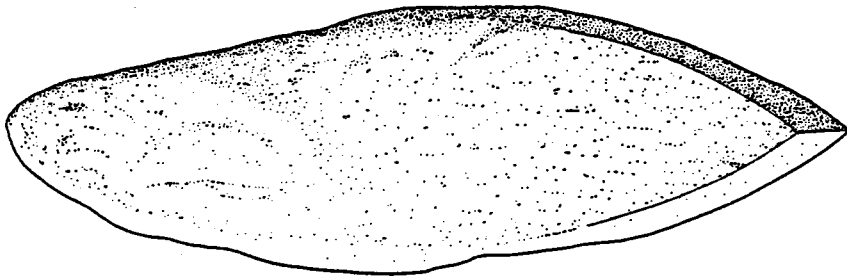
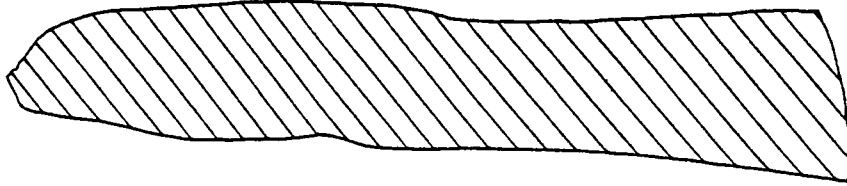
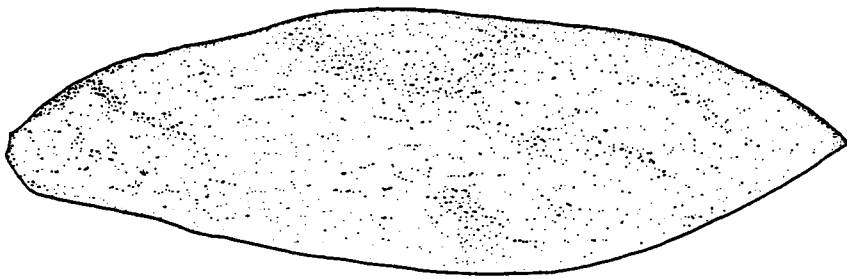

0 20

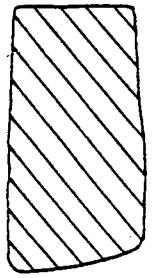

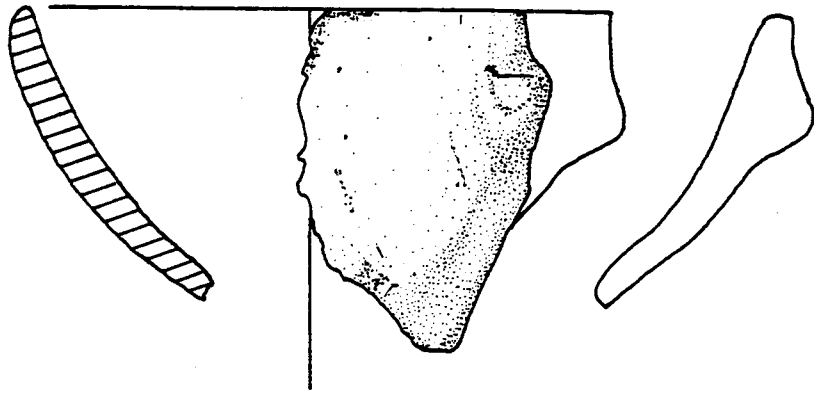

0 15

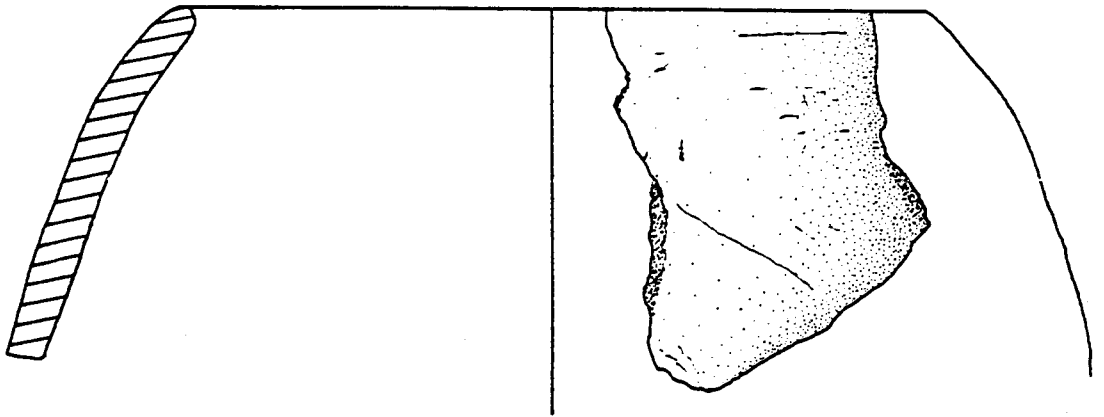

0 18

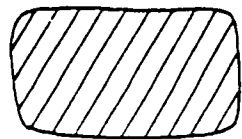
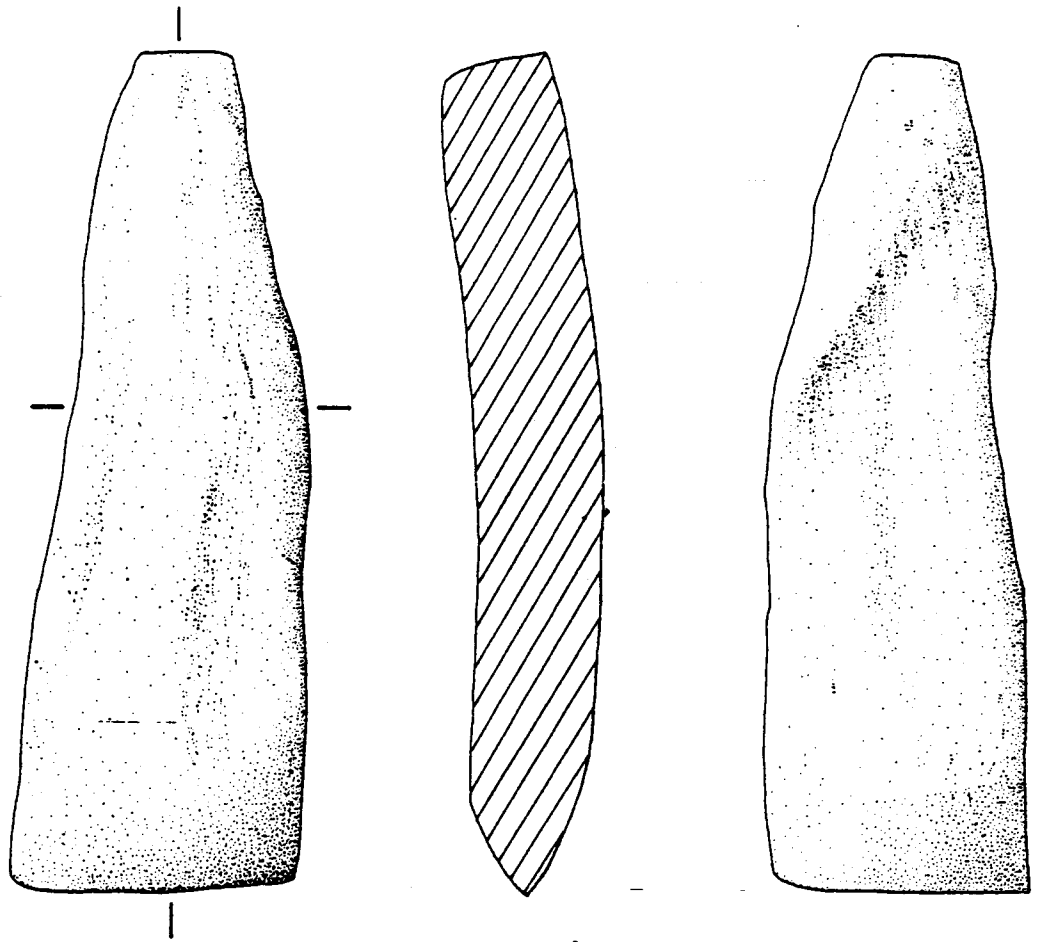
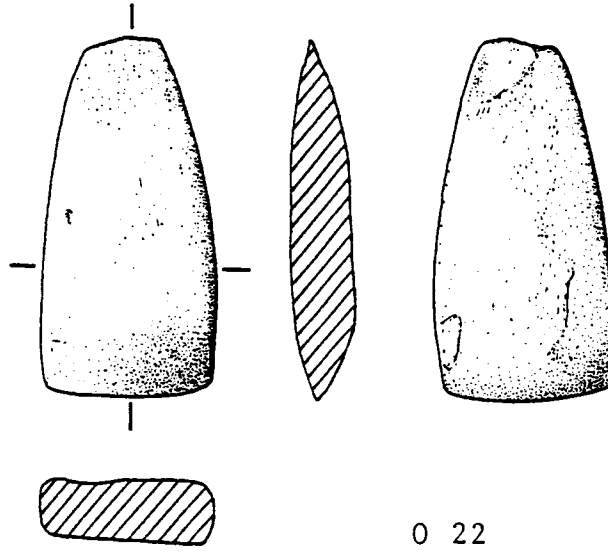

332

0

4 cm

0 24

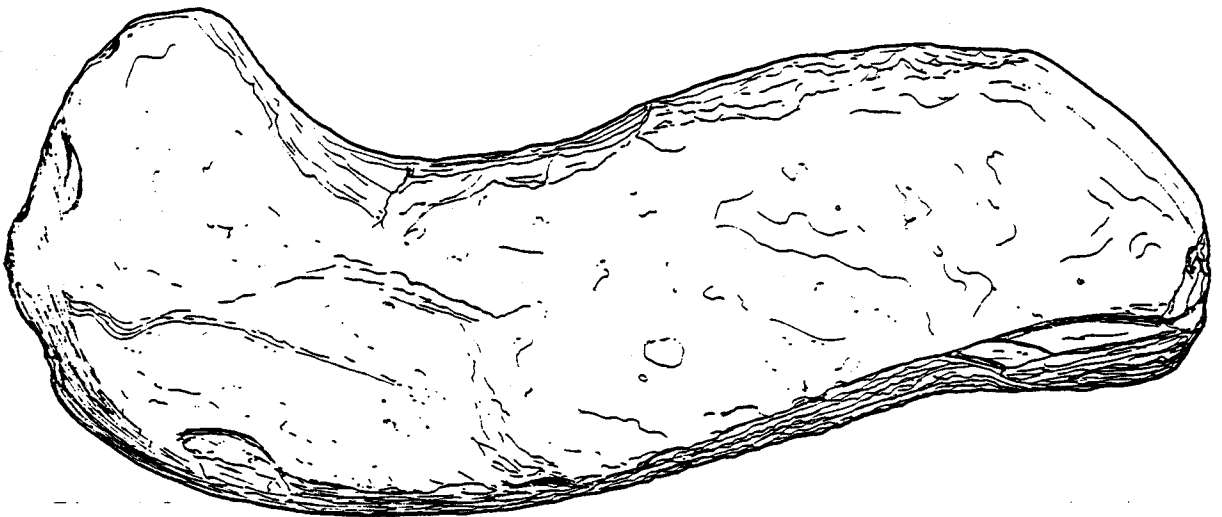
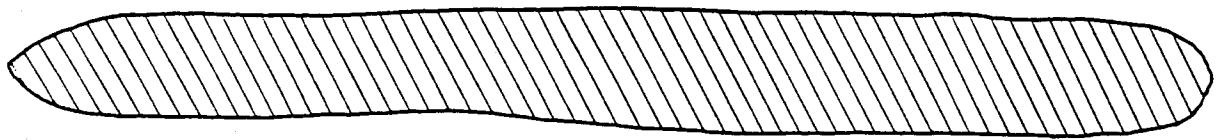
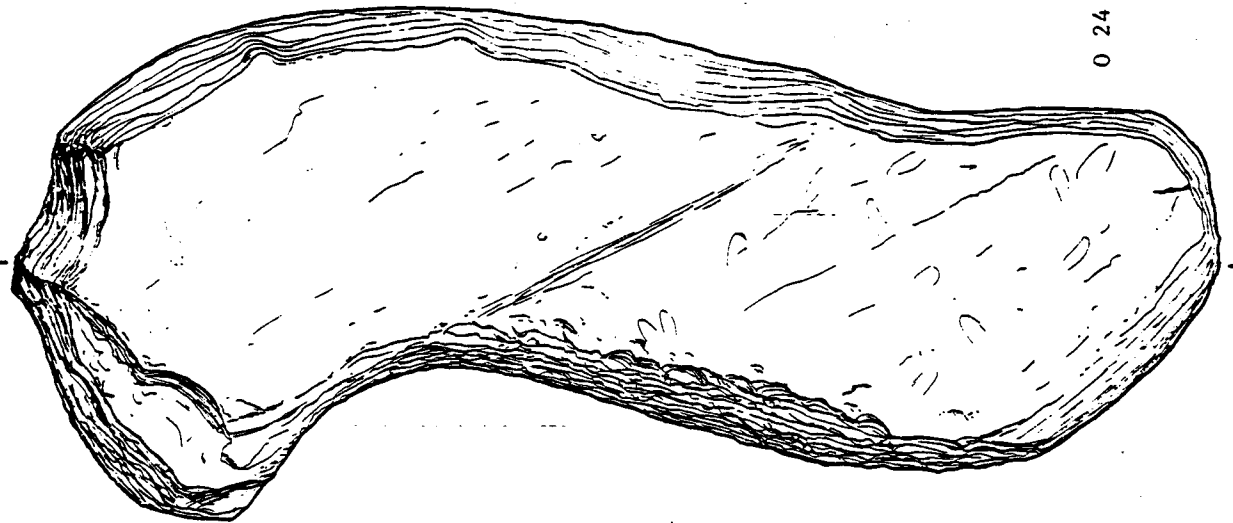

ANTA  
do  
**PAI ANES**





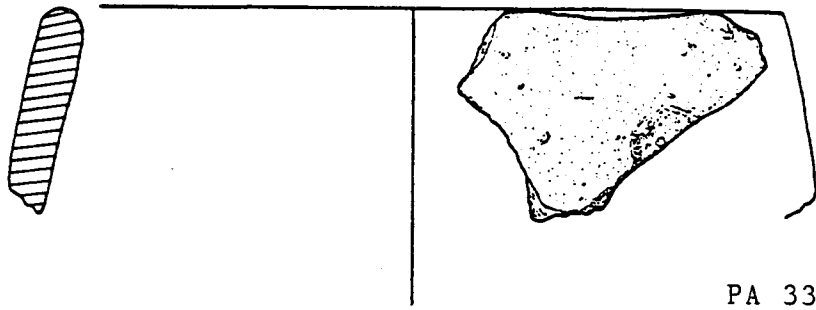

PA 33

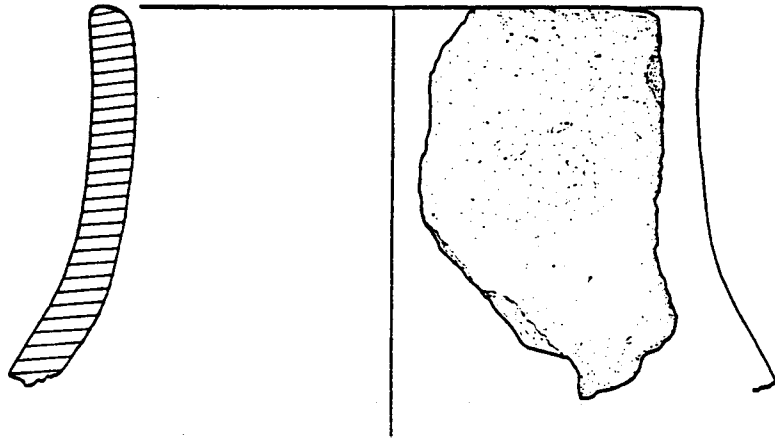

PA 34

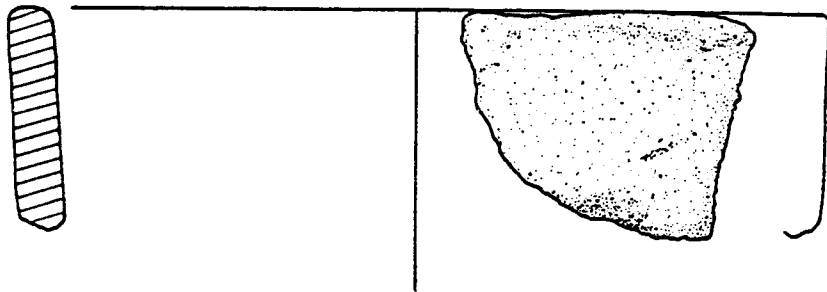

PA 37

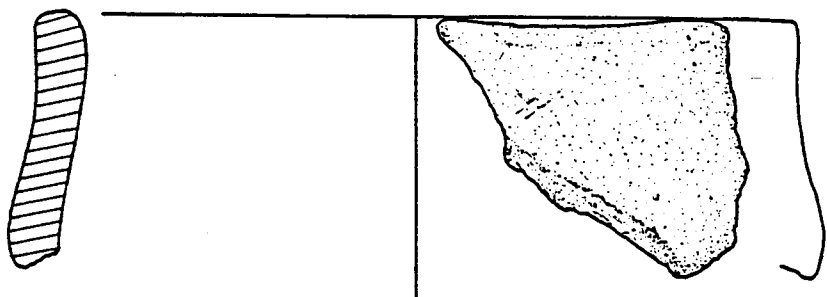

PA 38

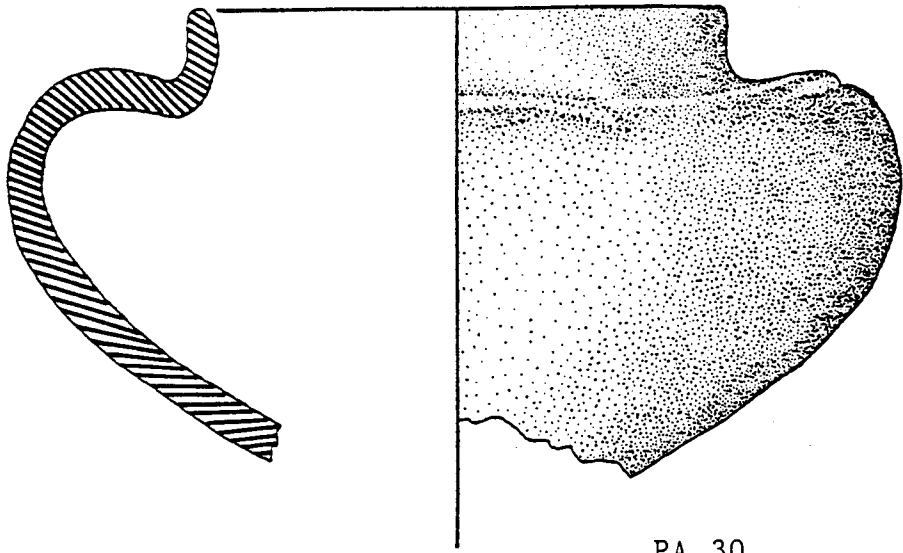

PA 30

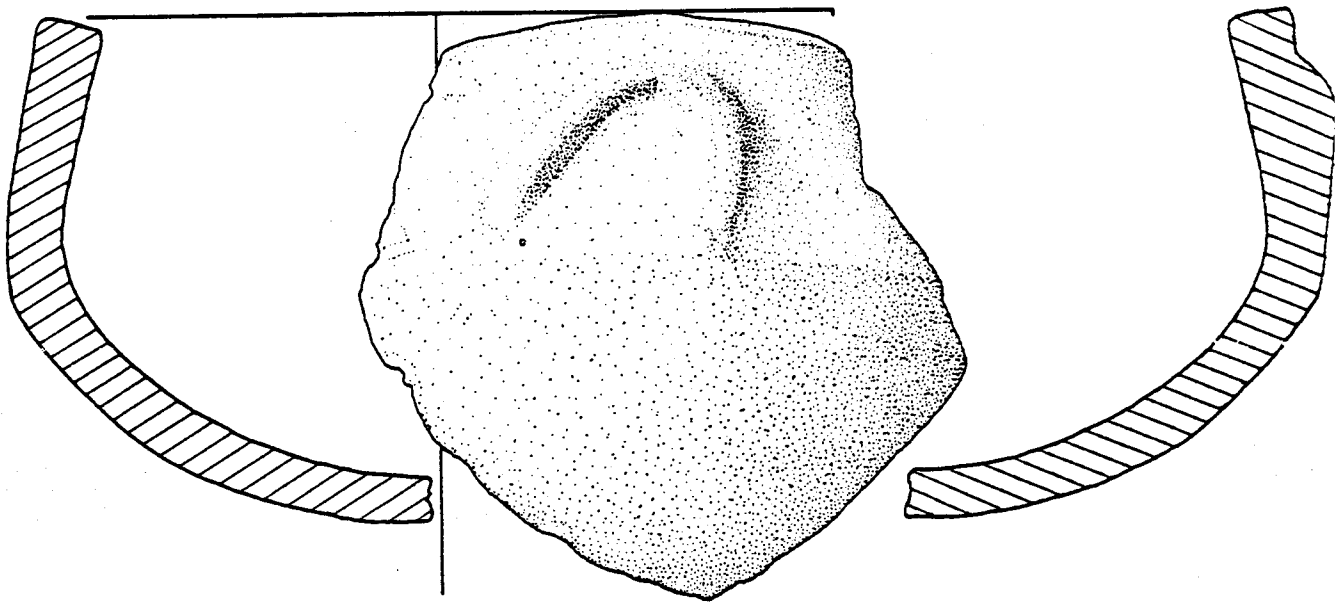

PA 31



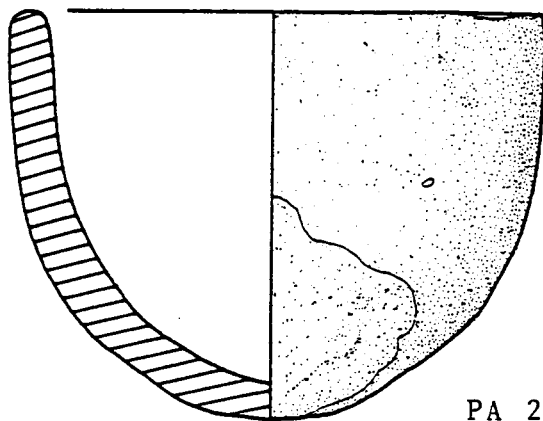

PA 29

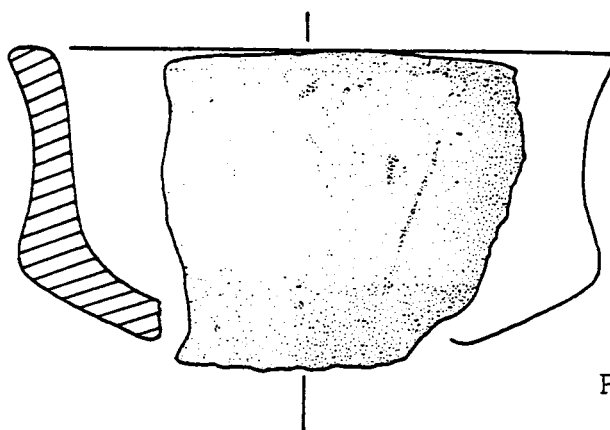

PA 32

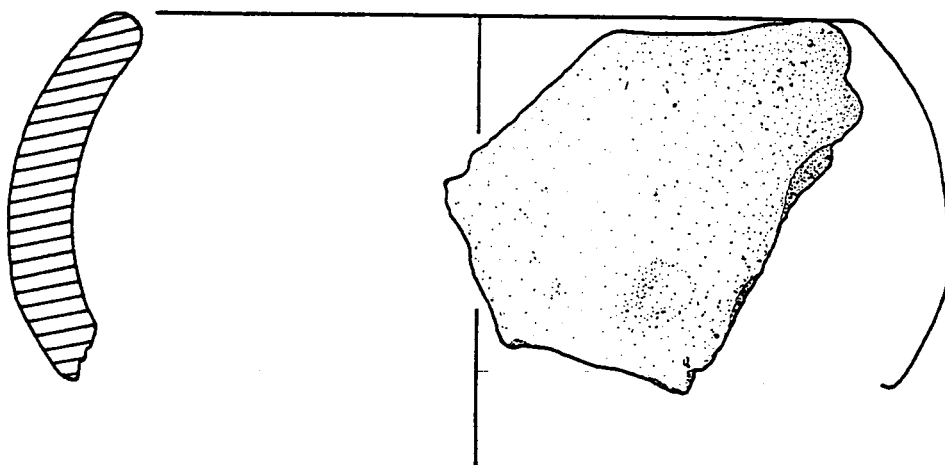

PA 31



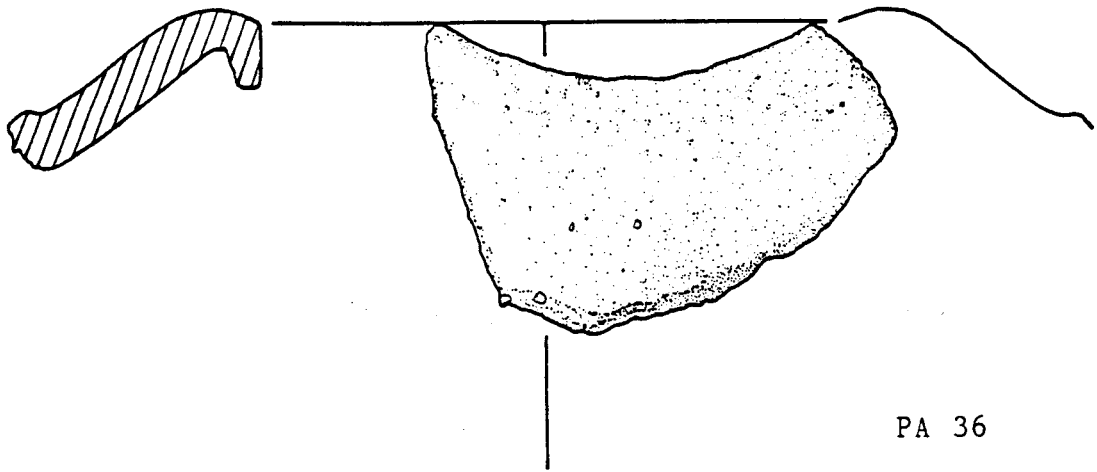

PA 36

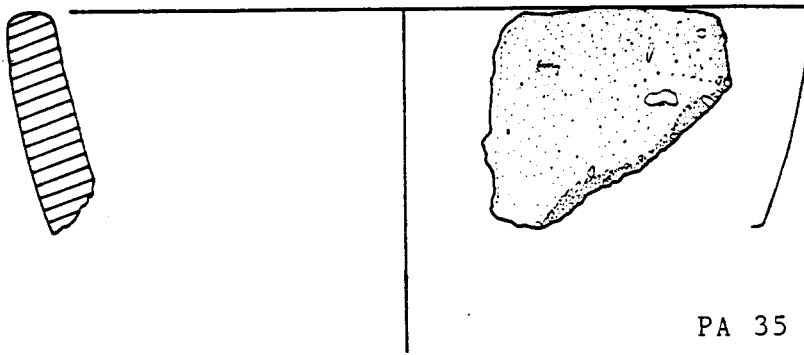

PA 35

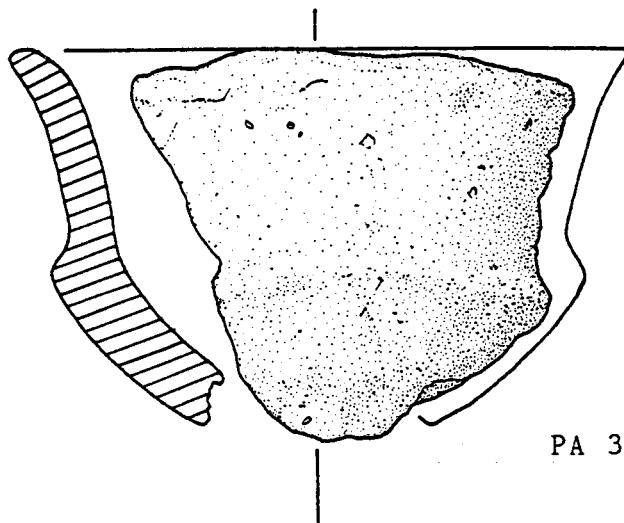

PA 39



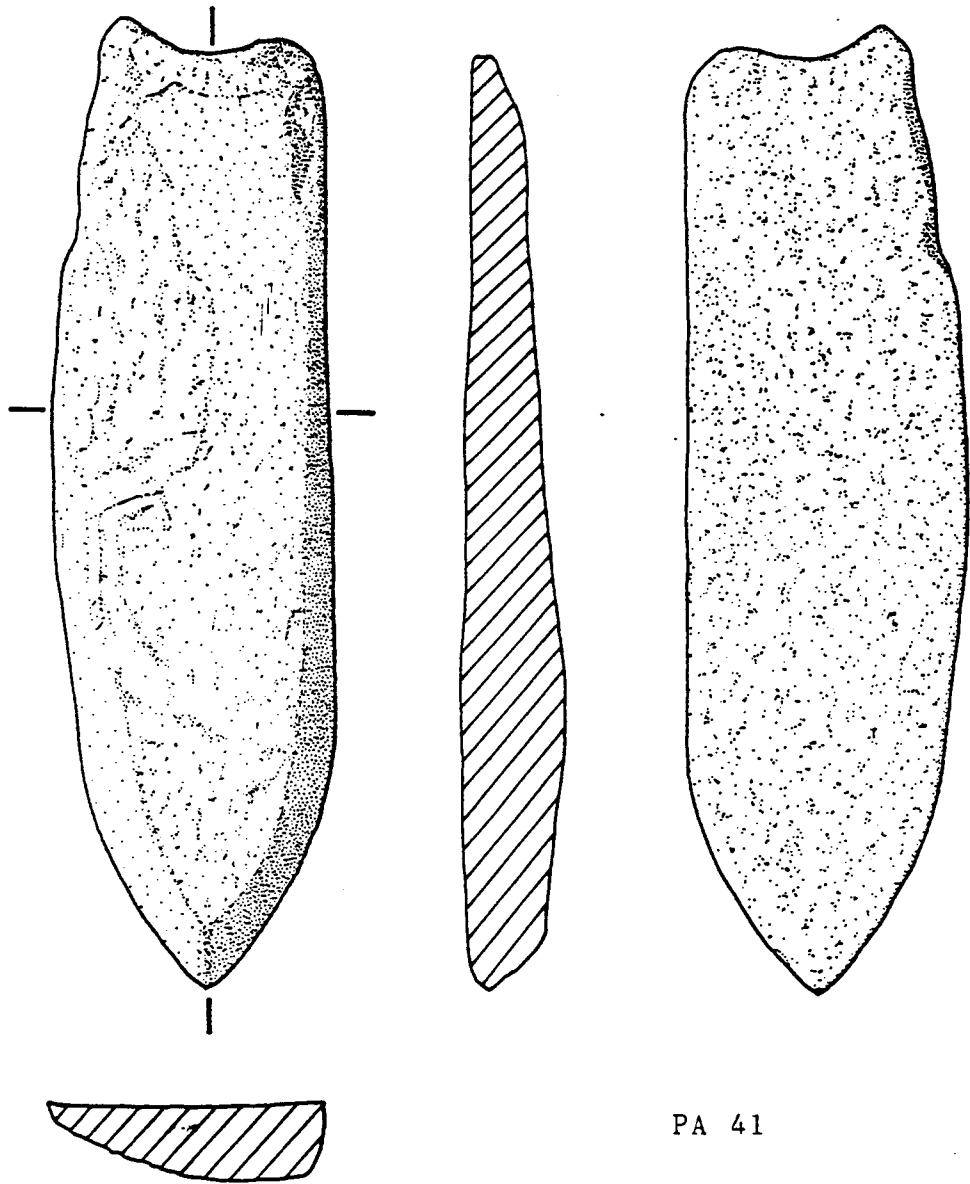

PA 41



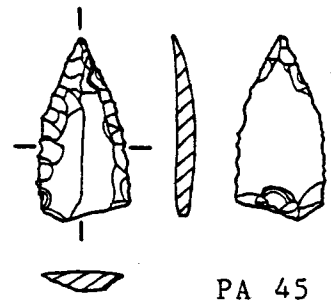
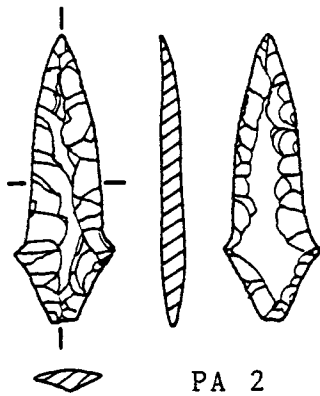
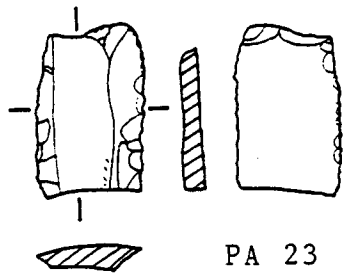
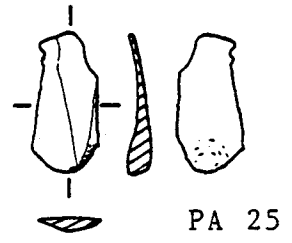
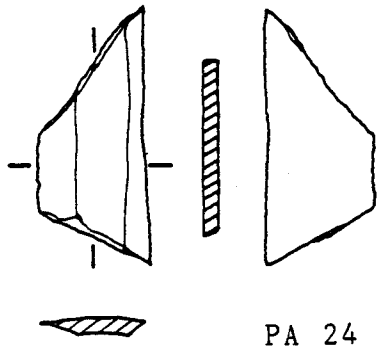

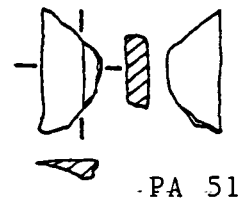
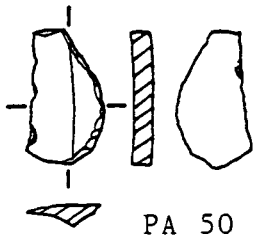
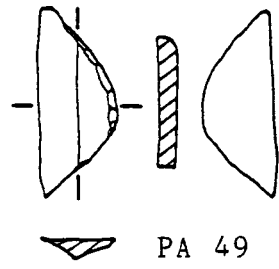
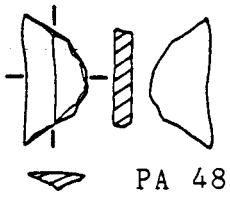
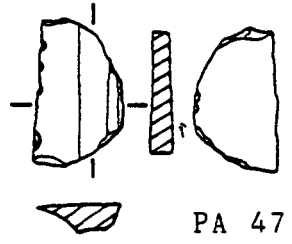
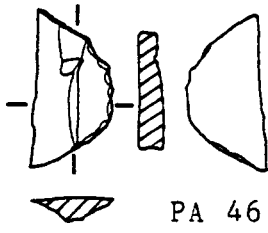





ANTA  
do  
**PORTO AIVADO**



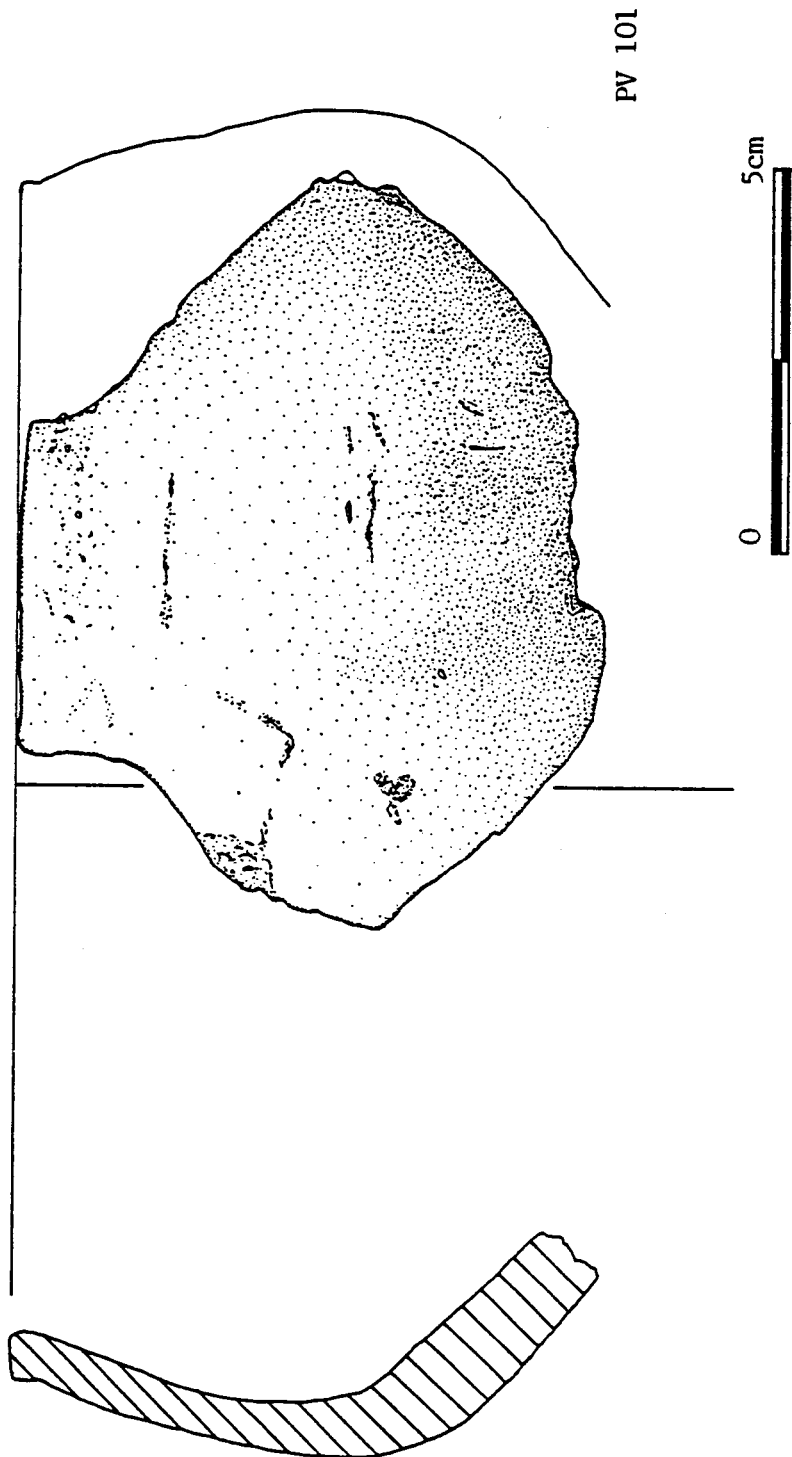

PV 101

0 5cm

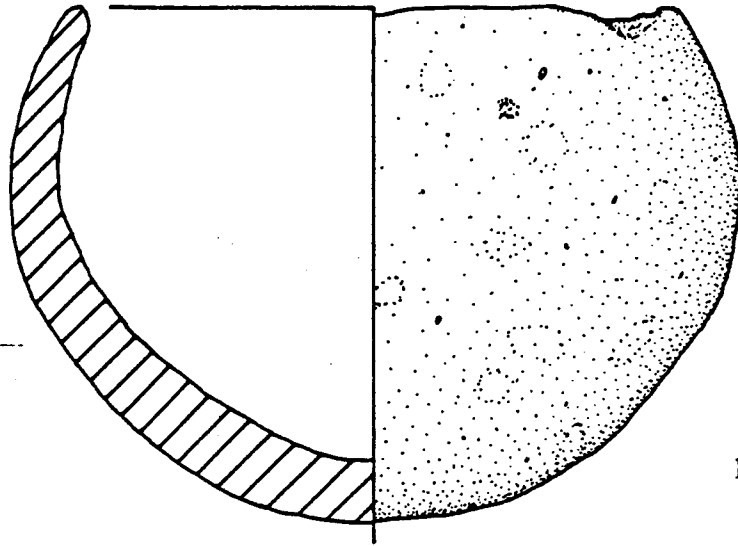

PV 100

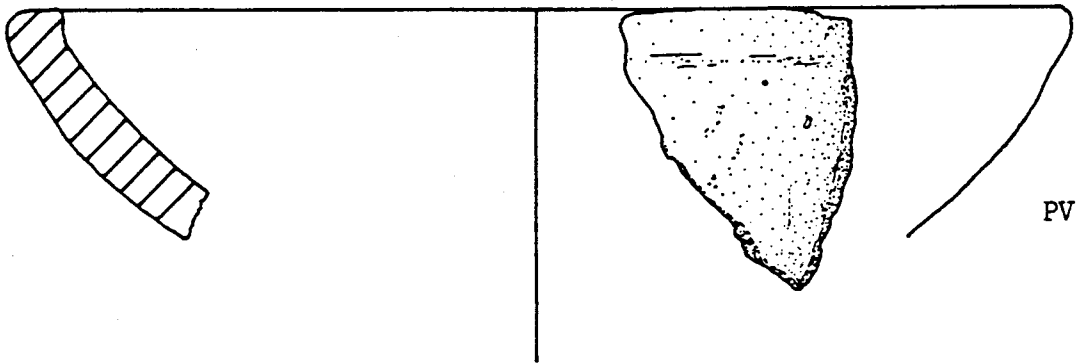

PV 136



PV 132



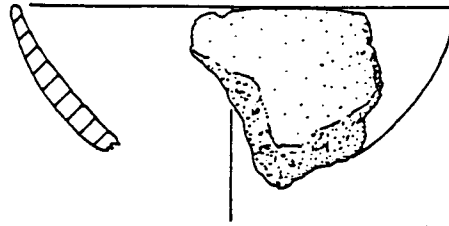

PV 50

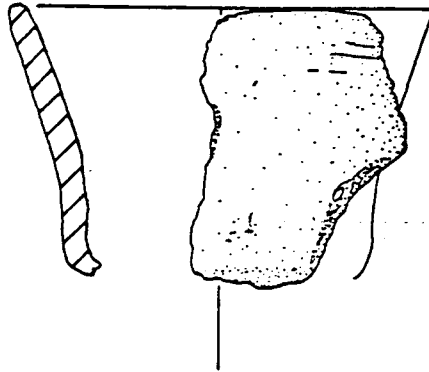

PV 163

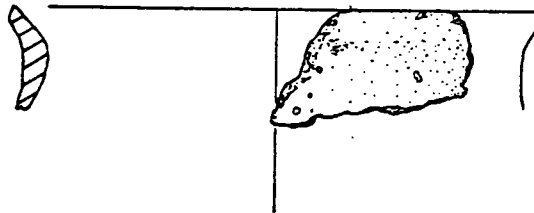

PV 168

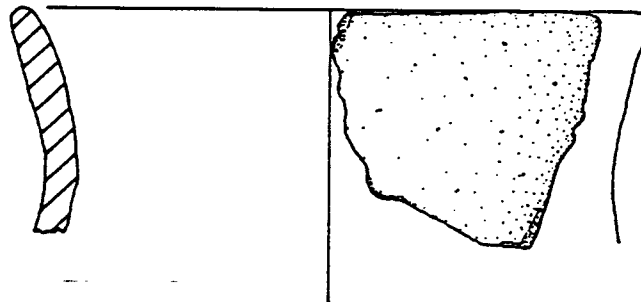

PV 112



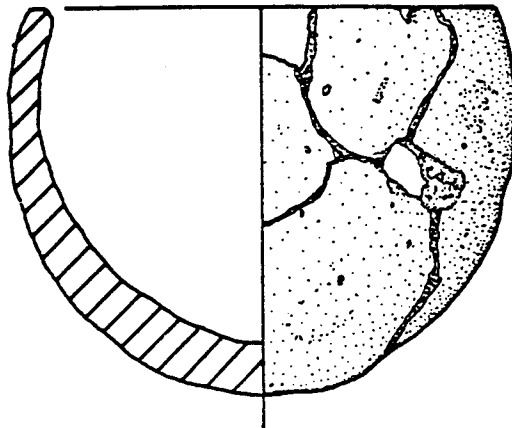

PV 49

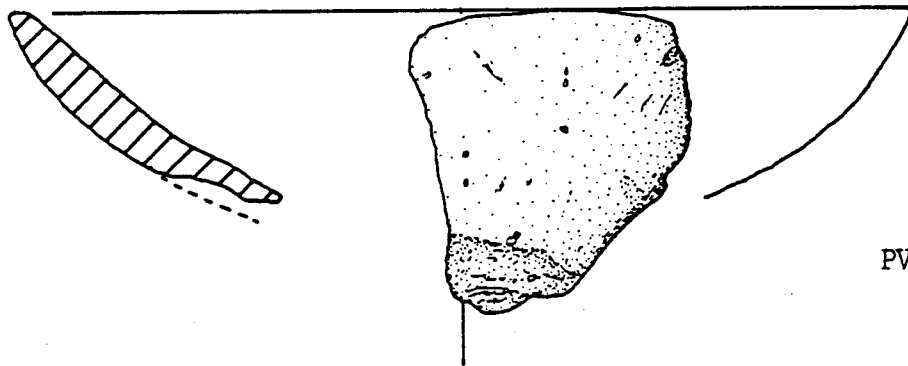

PV 45

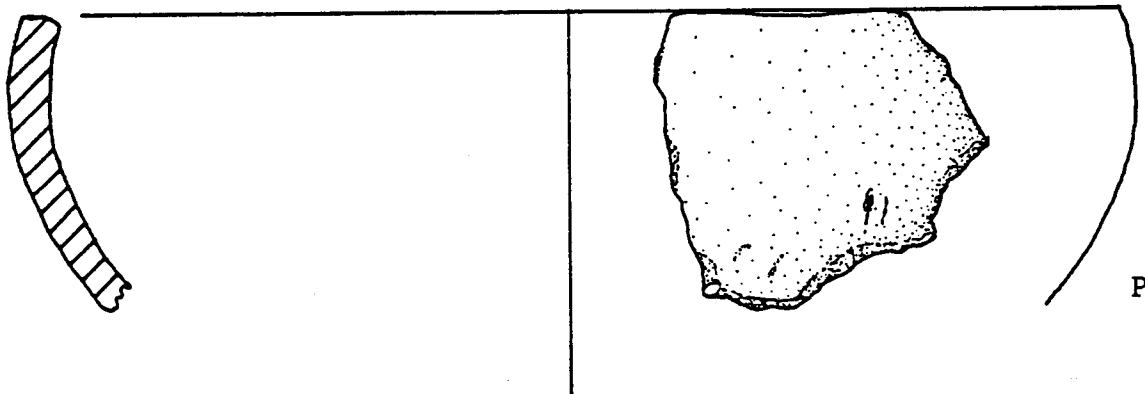

PV 105



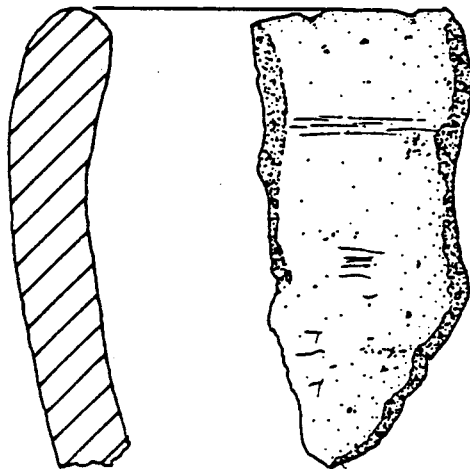

PV 110

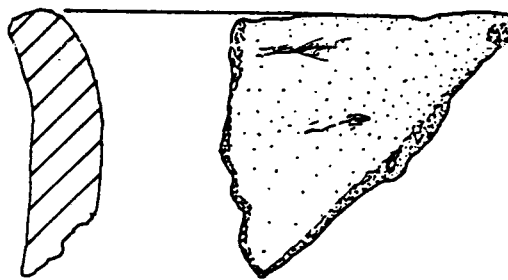

PV 99

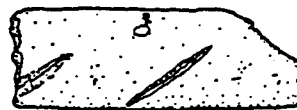



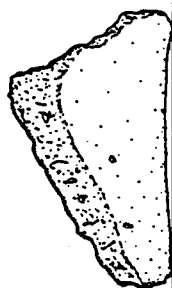

PV 148

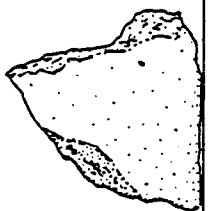
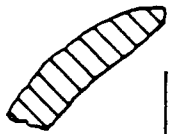

PV 149



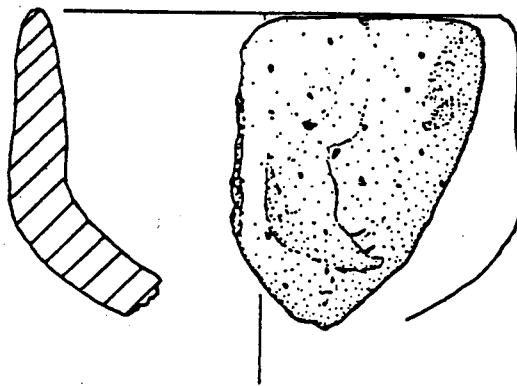

PV 62 -----

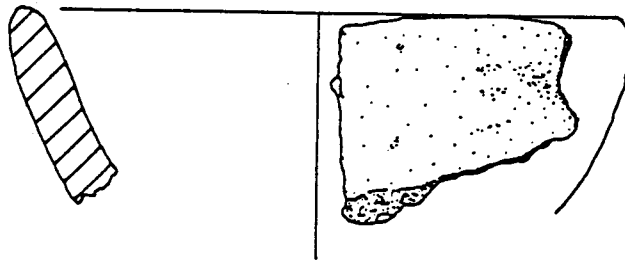

PV 36

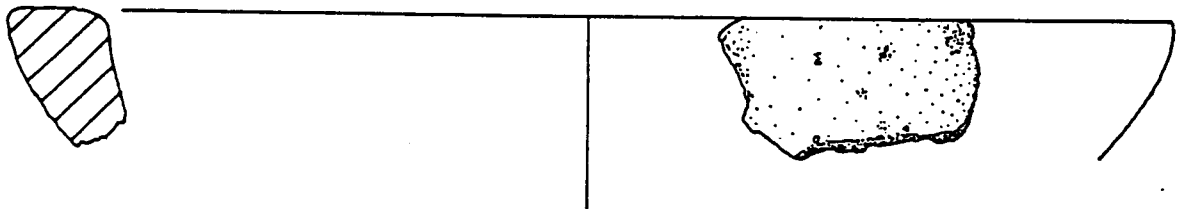

PV 54



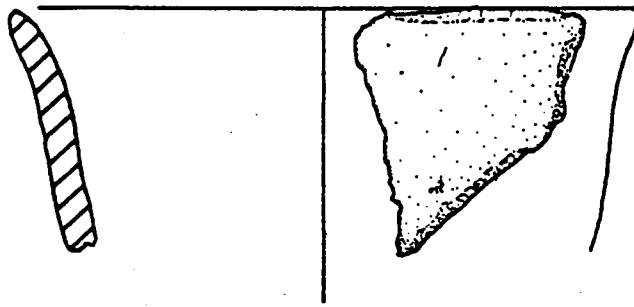

PV 167

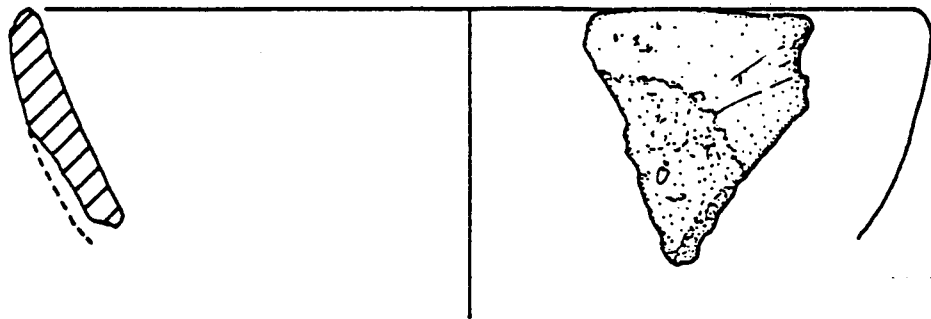

PV 165

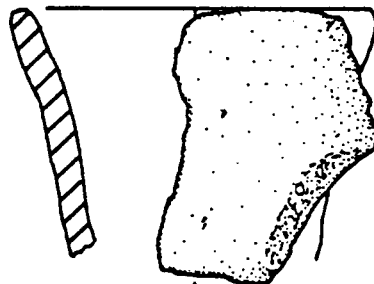

PV 163

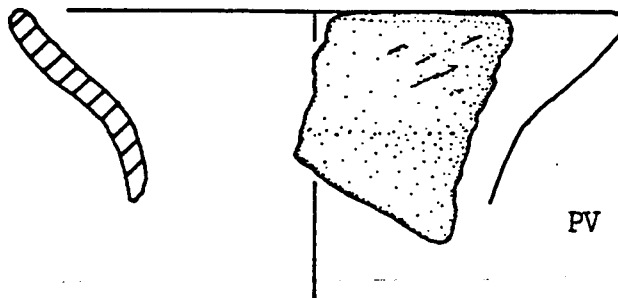

PV 73



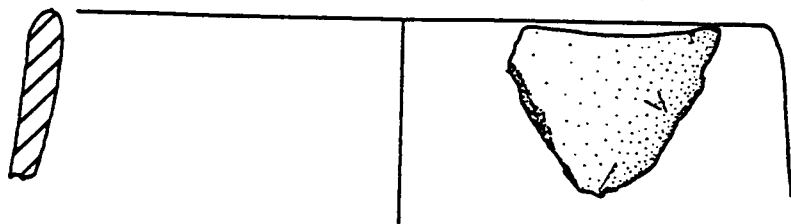

PV 143

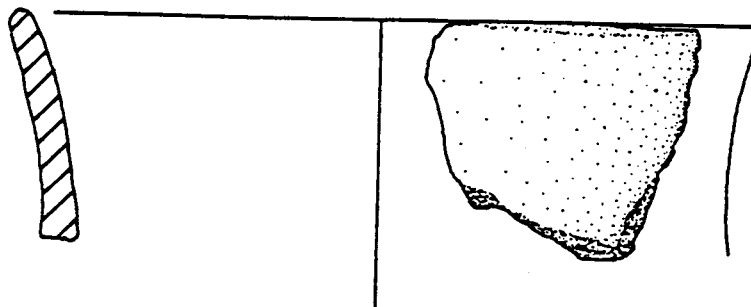

PV 112

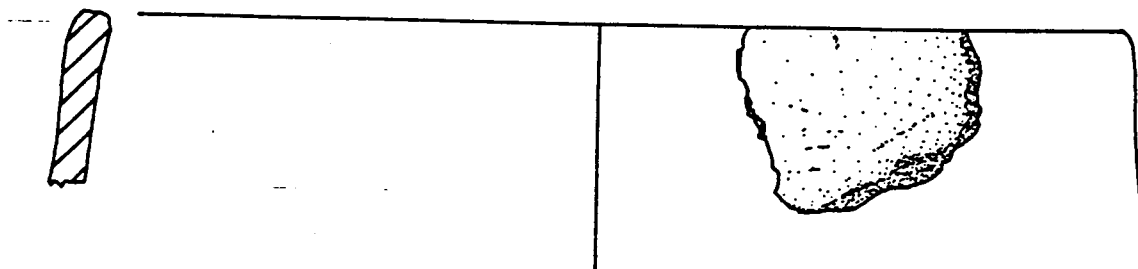

PV 7



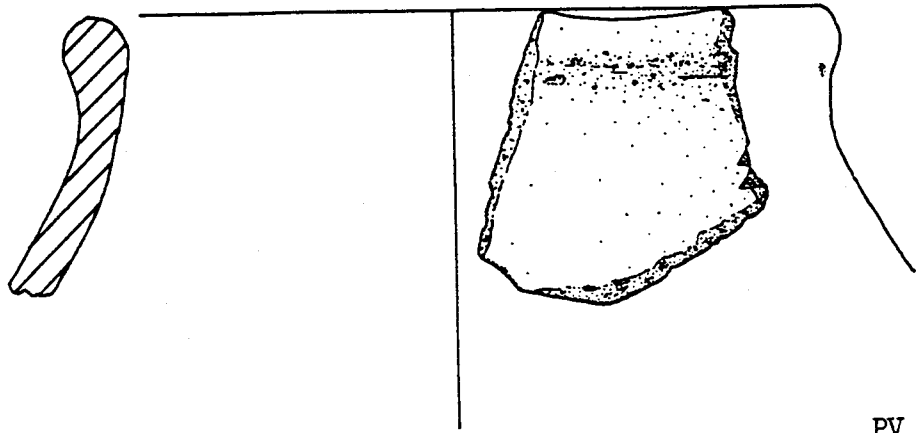

PV 114

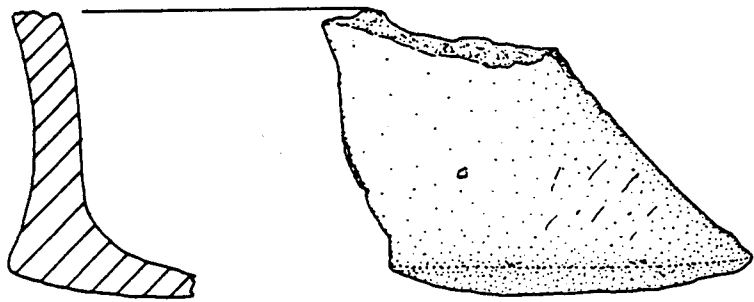

PV 106

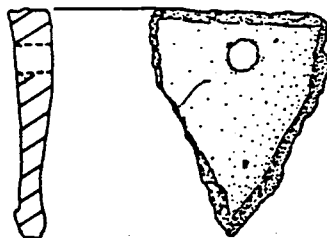

PV 40



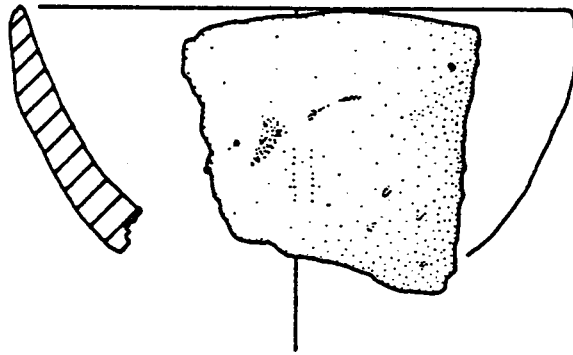

PV 104

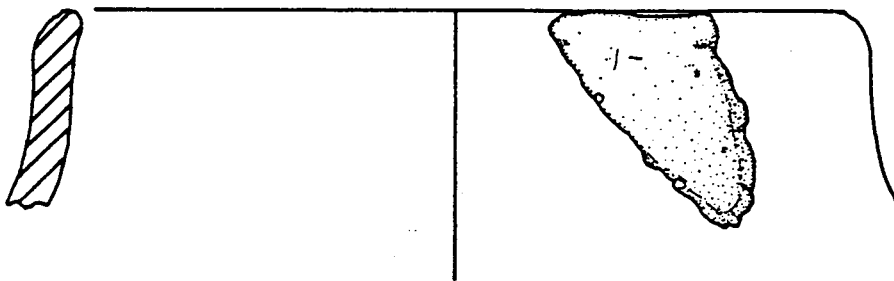

PV 60

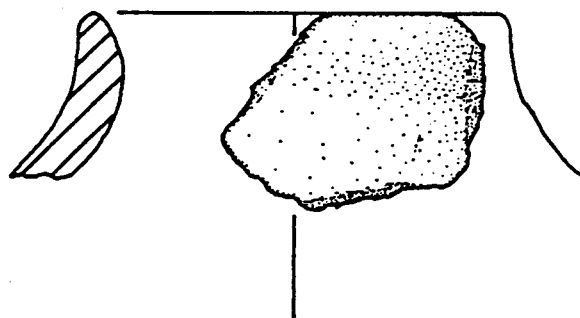

PV 98



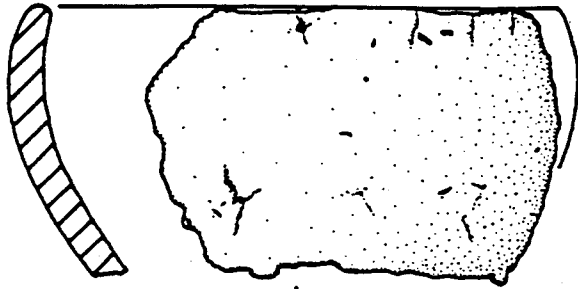

PV 77

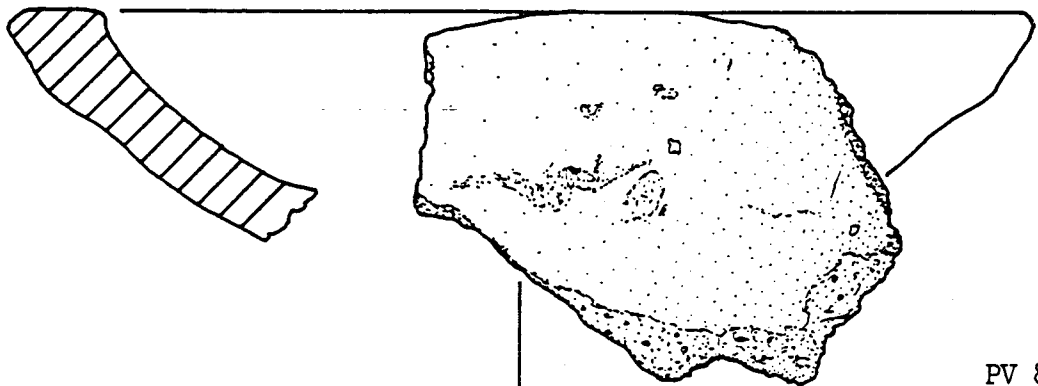

PV 86

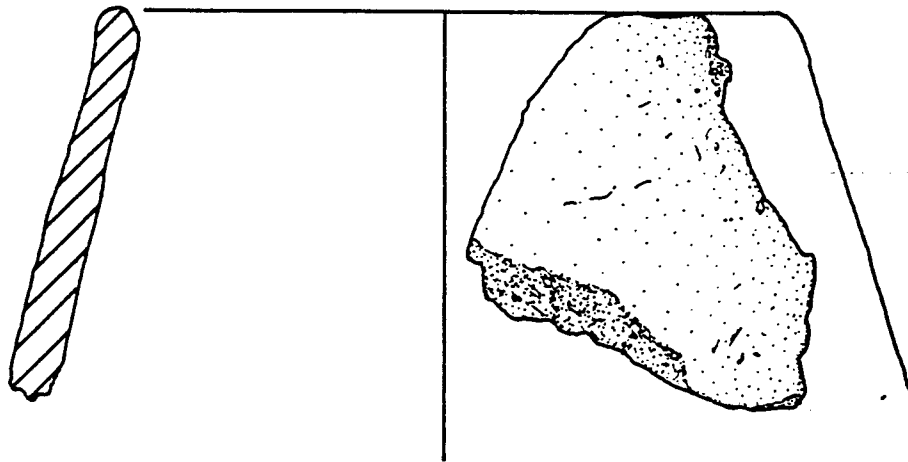

PV 69

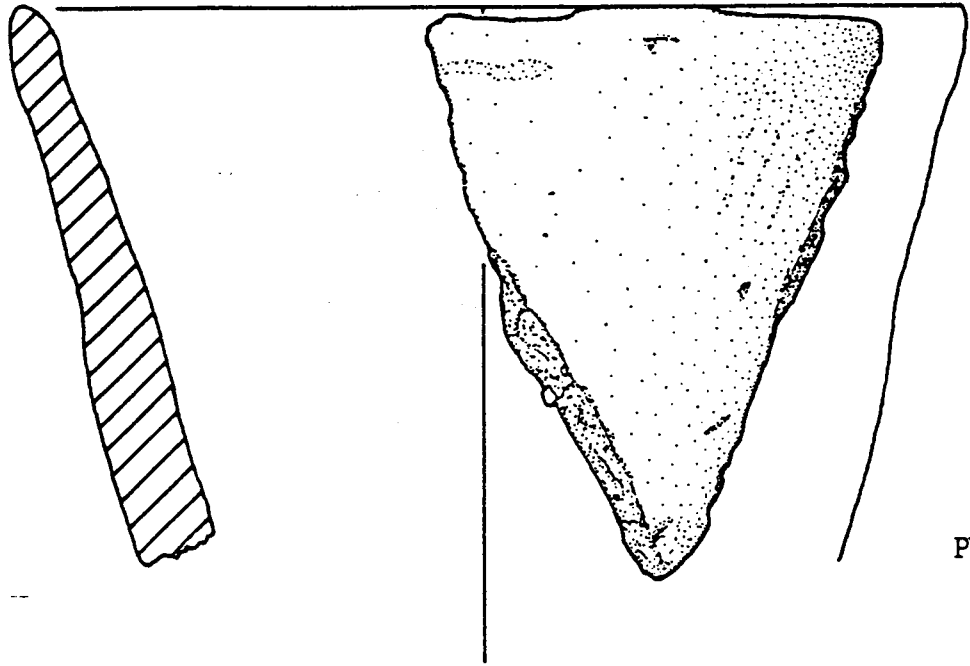

PV 44

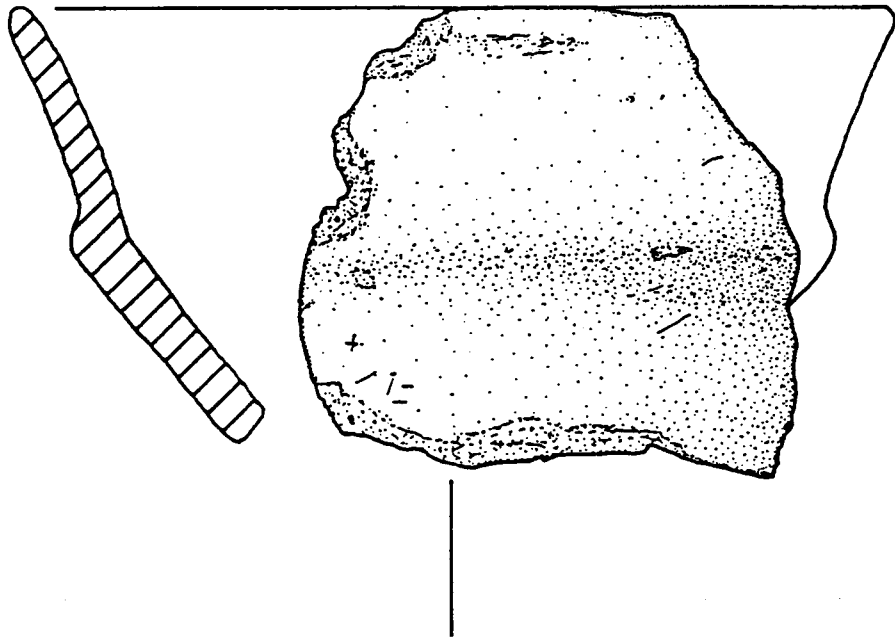

PV 102





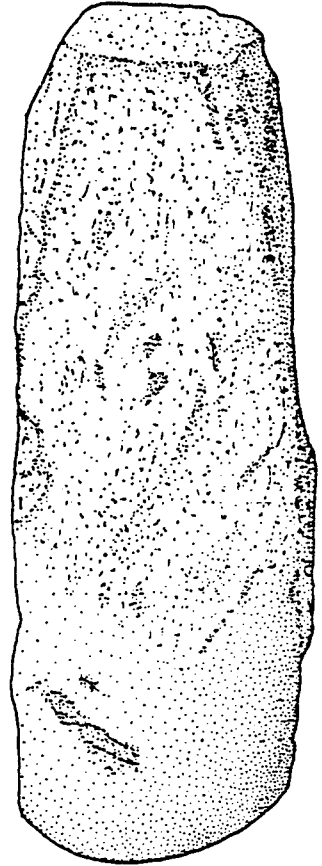
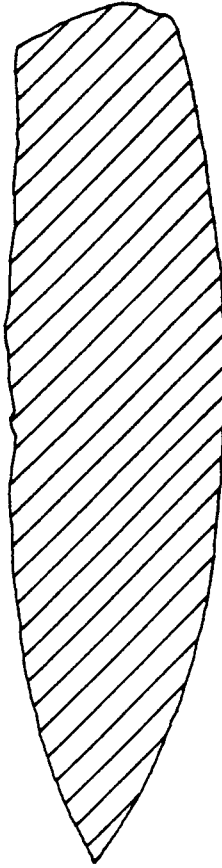
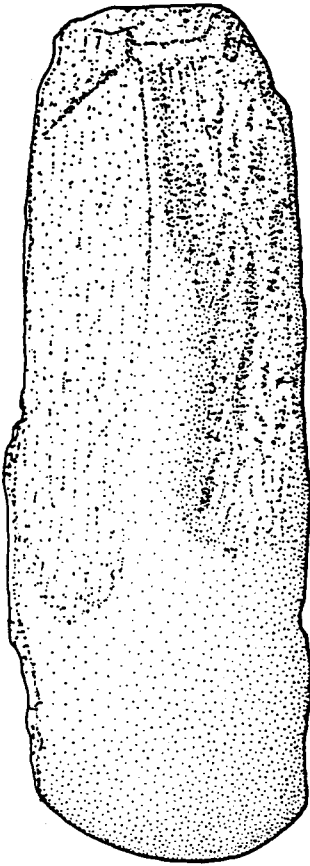

PV 206

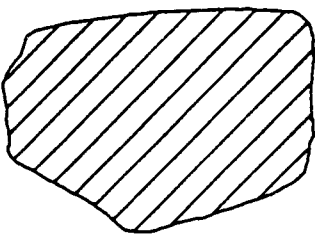

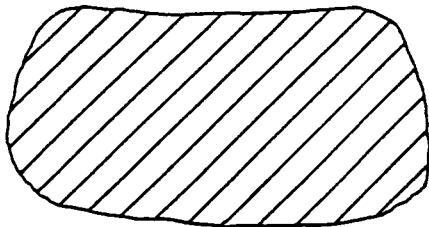
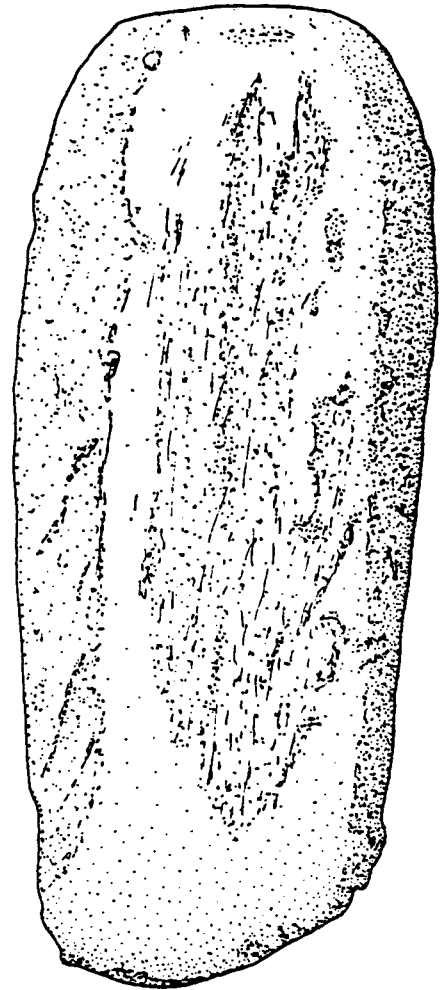
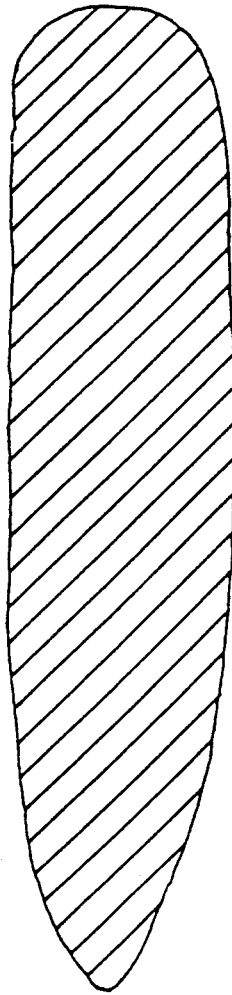

PV 207



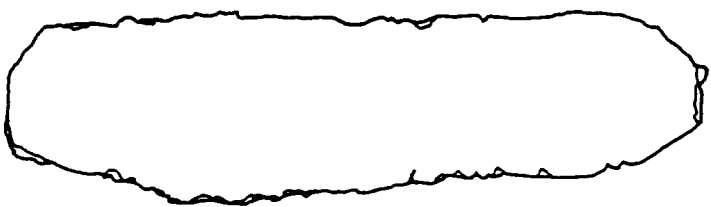
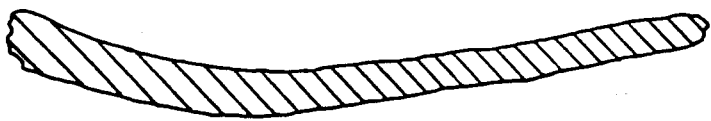

PV 192

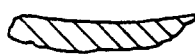

PV 189



PV 193

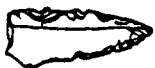

PV 186



PV 191

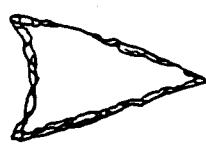
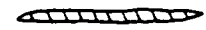
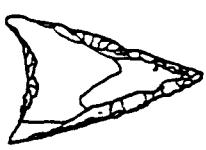

PV 164



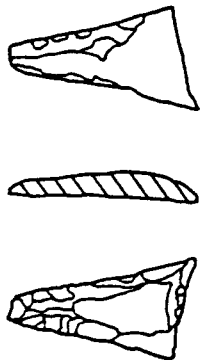

PV 195



PV 187

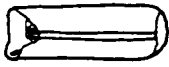

PV 196

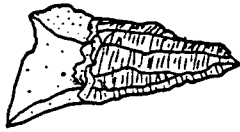

PV 188

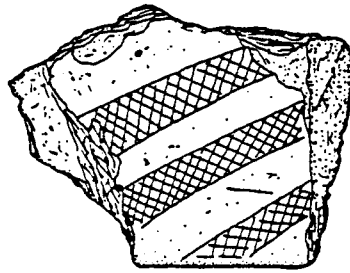

PV 197

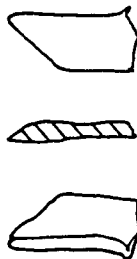
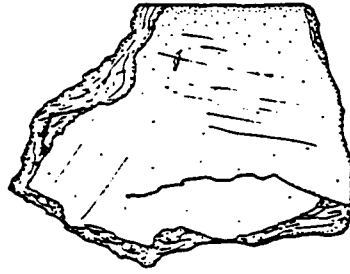

PV 190

5cm

0



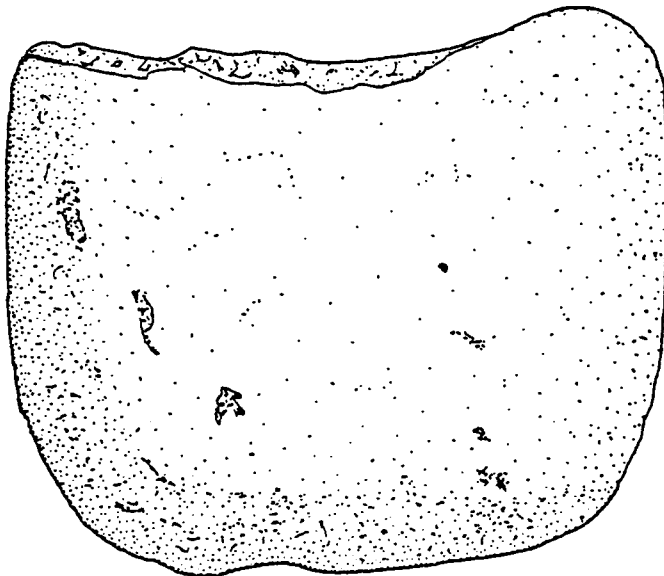
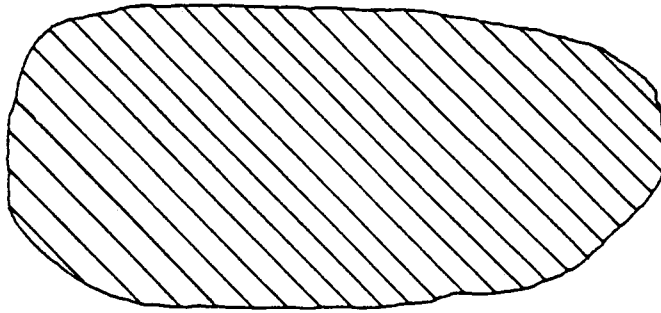
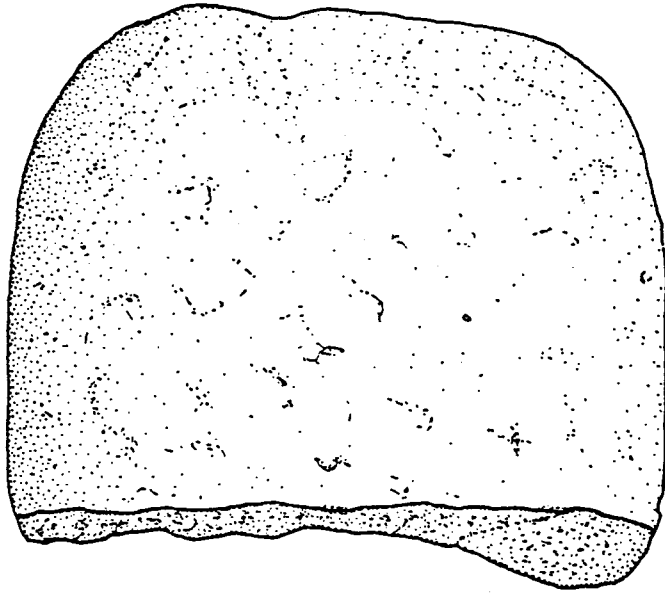

PV 219

PV 211

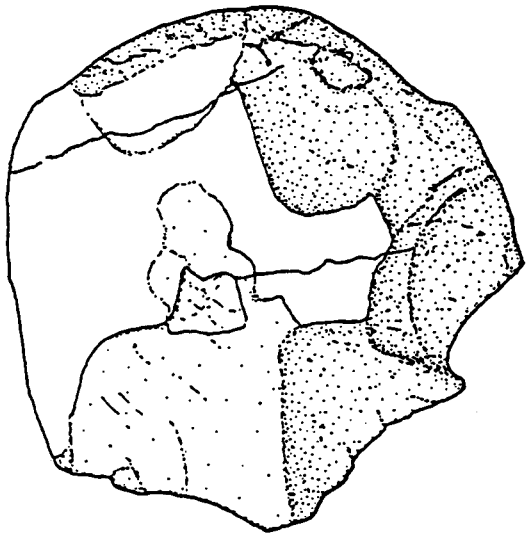
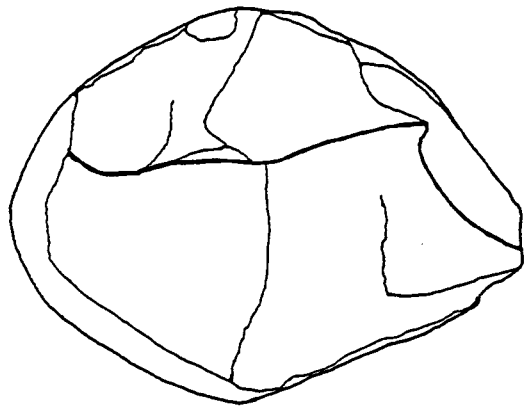
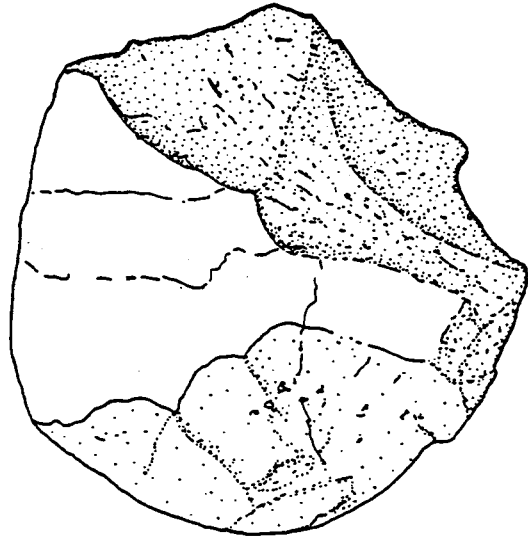

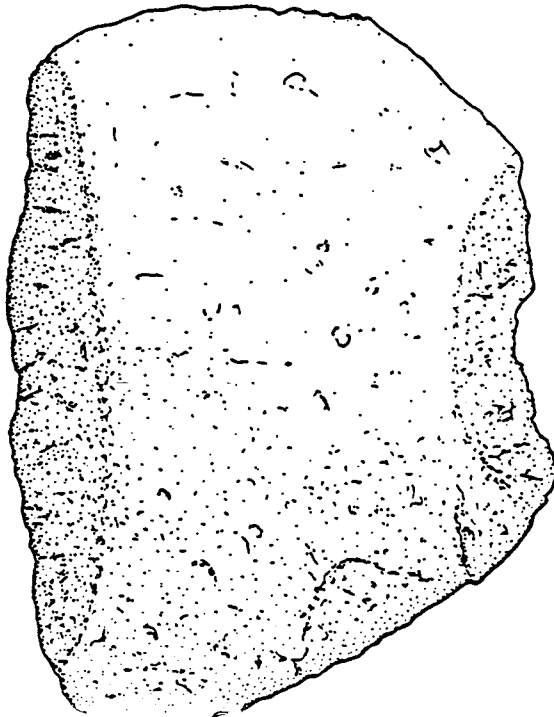
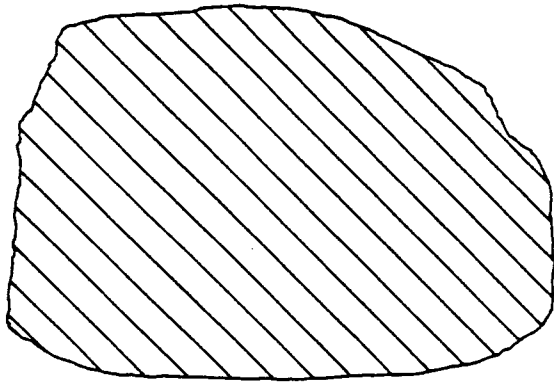
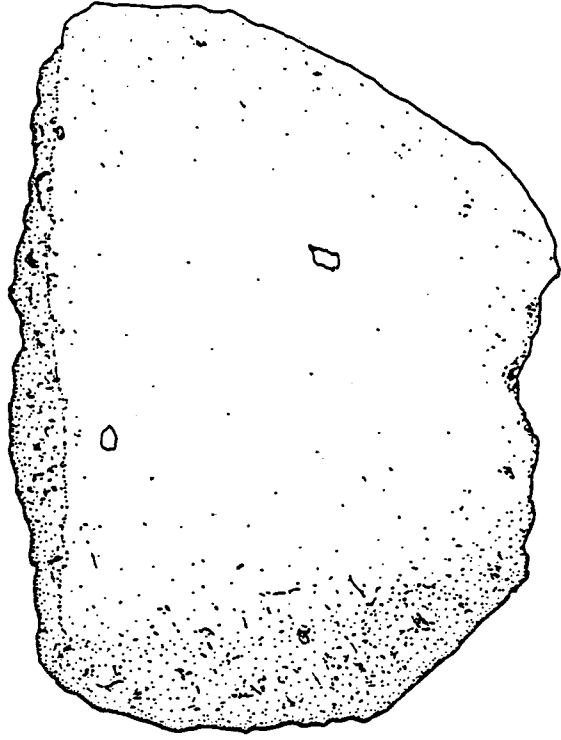

PV 218

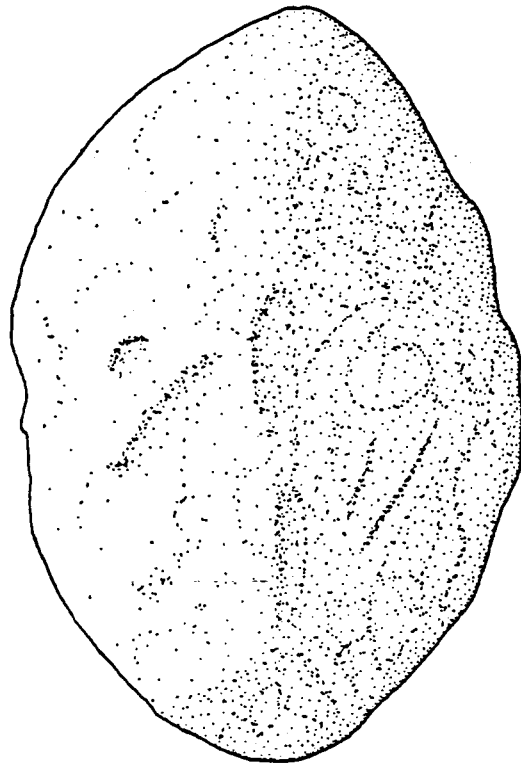

PV 214

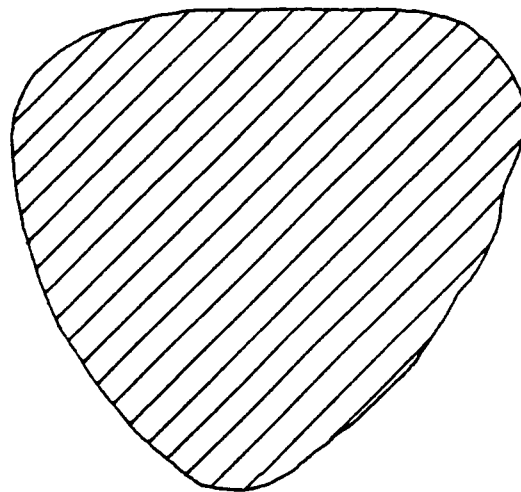



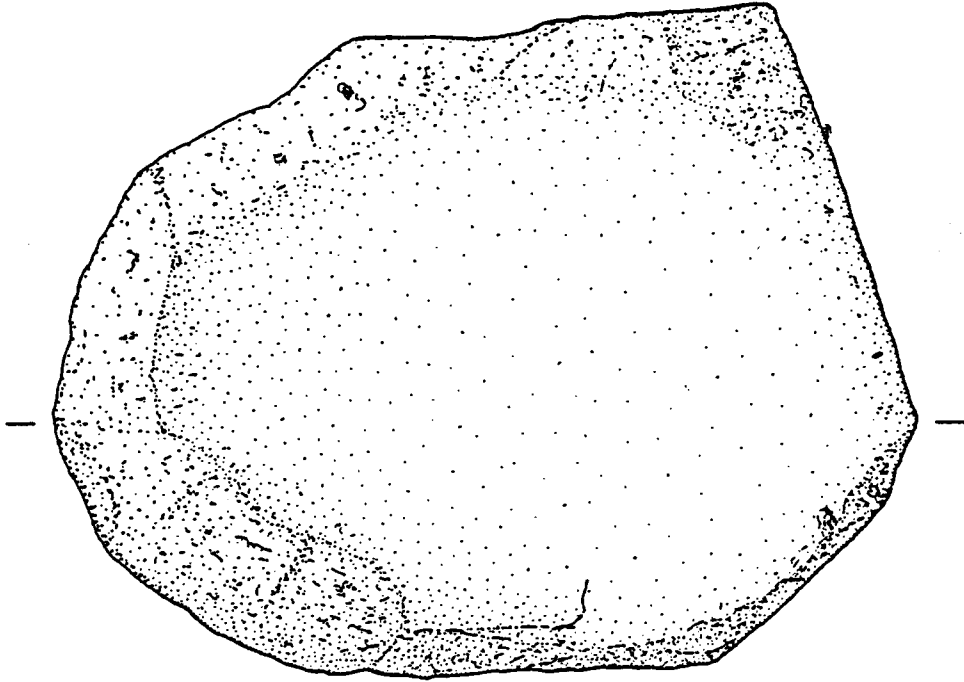

PV 221

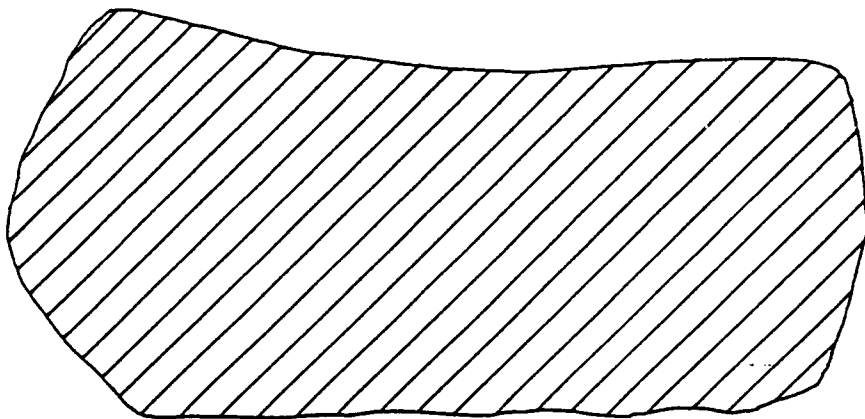

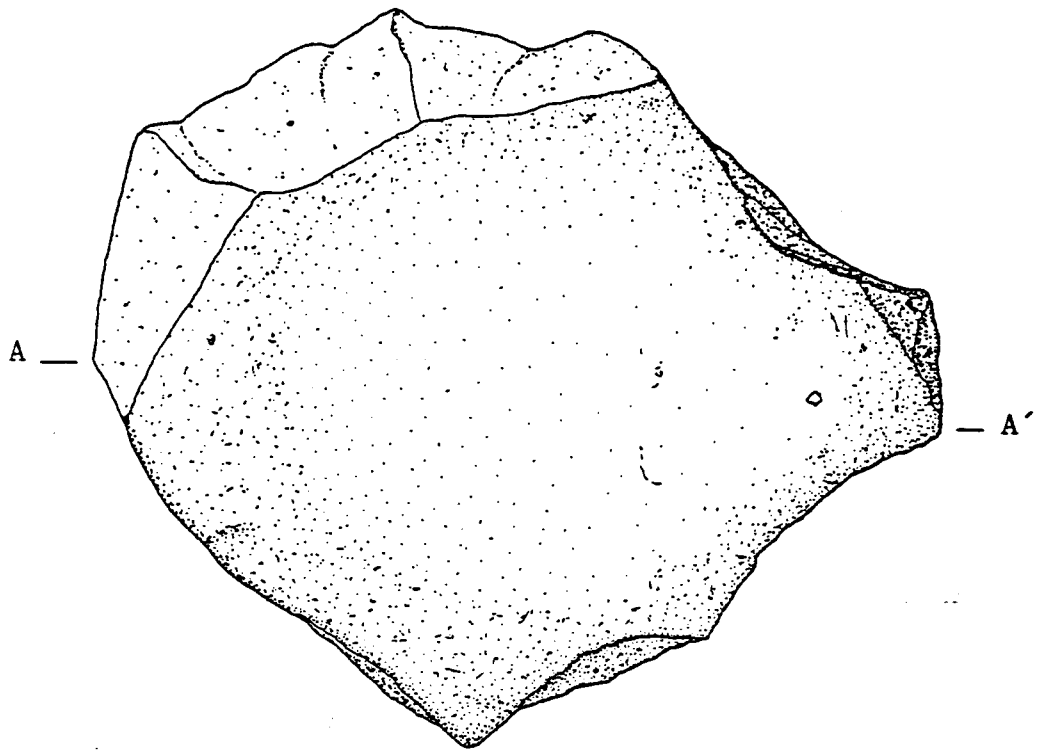

PV 222

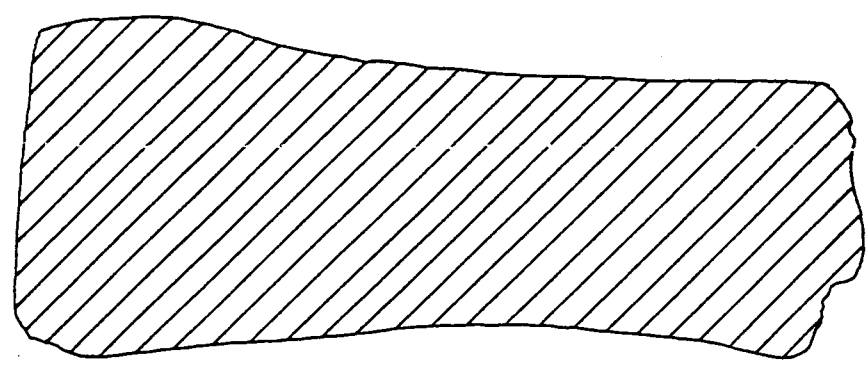



ANTA  
do  
**SOBRAL**



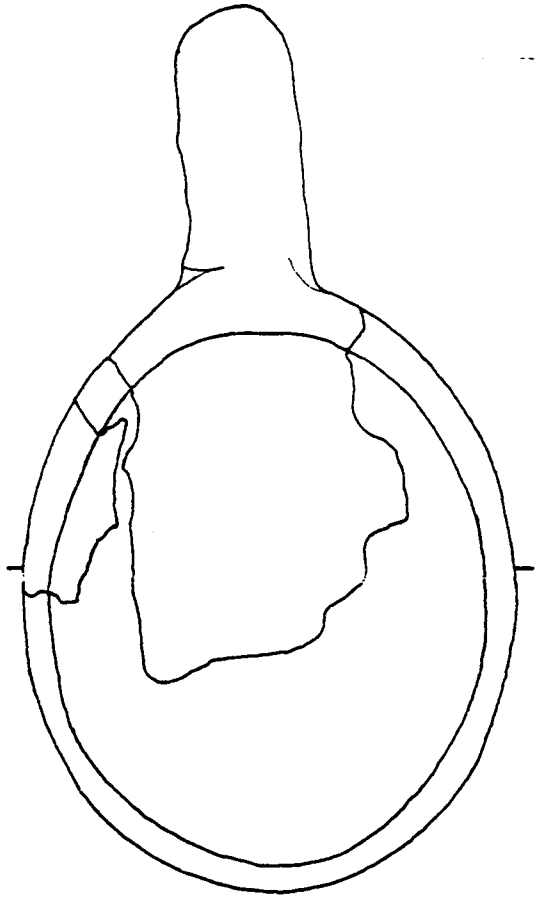
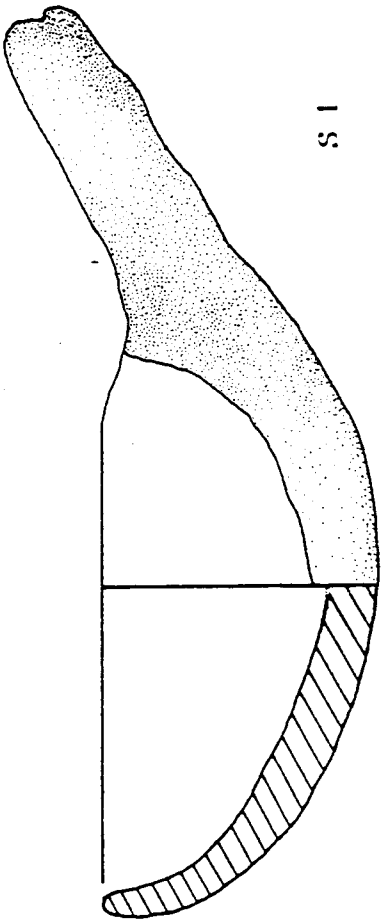

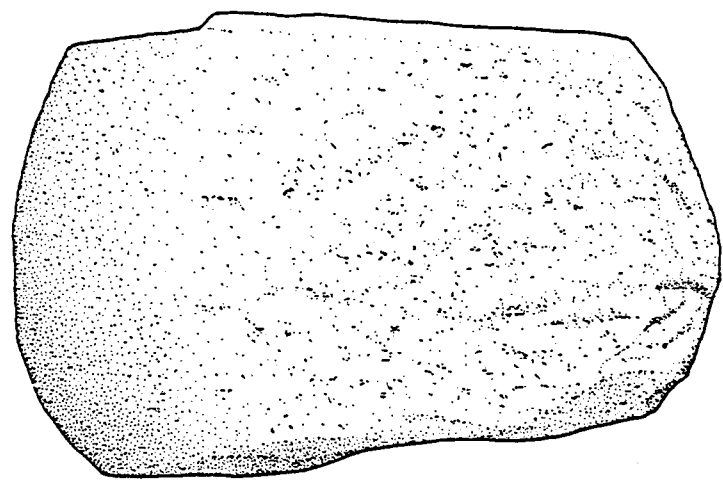
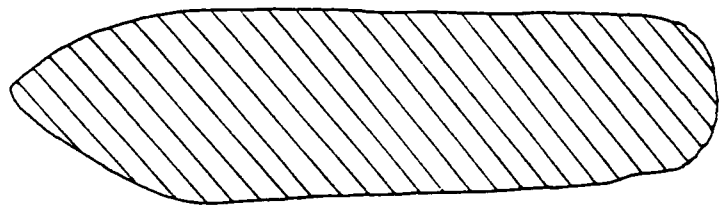
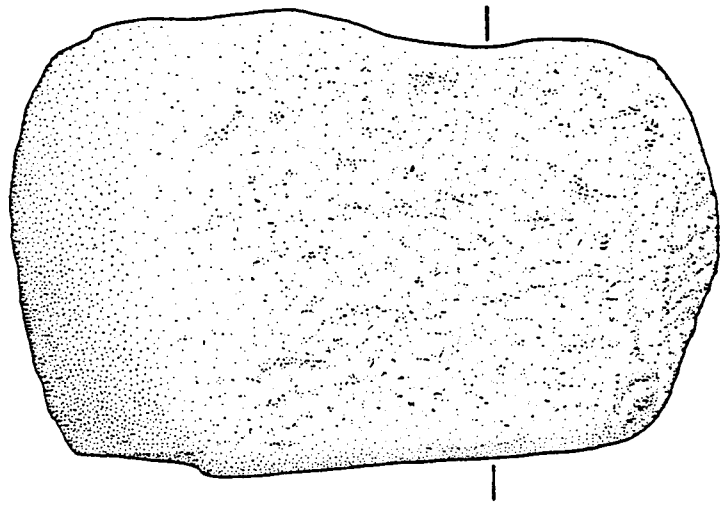
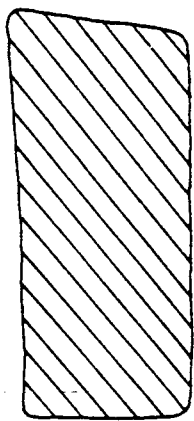

S 2

ANTA  
da  
**TAPADA DE MATOS**





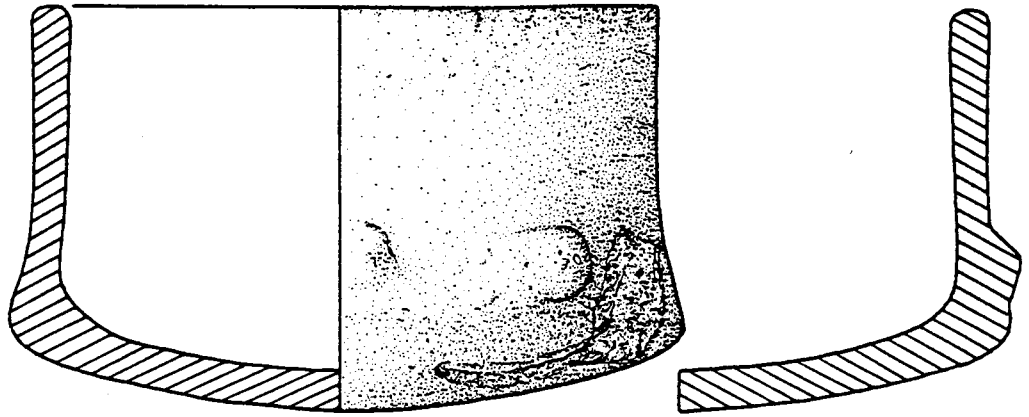

TM 1

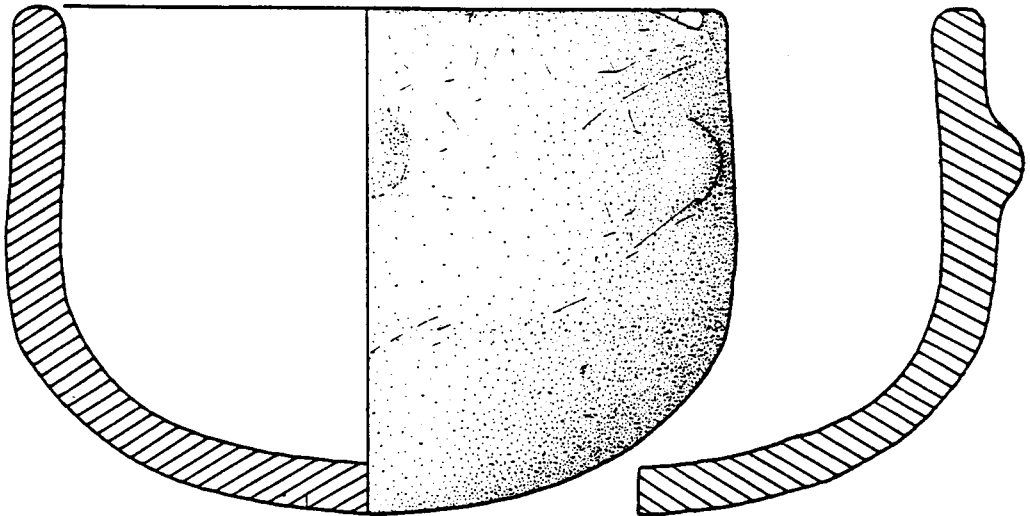

TM 3



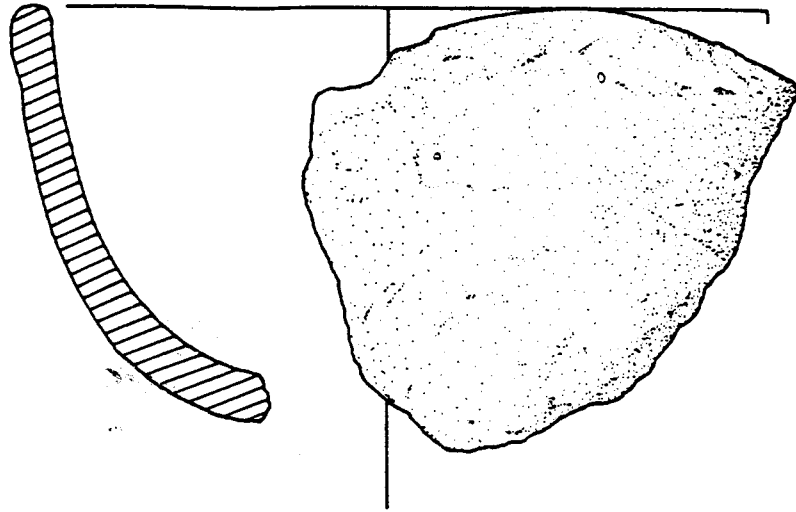

TM 9

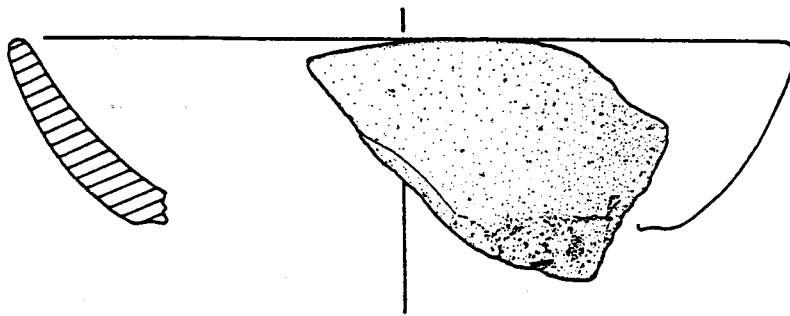

TM 11



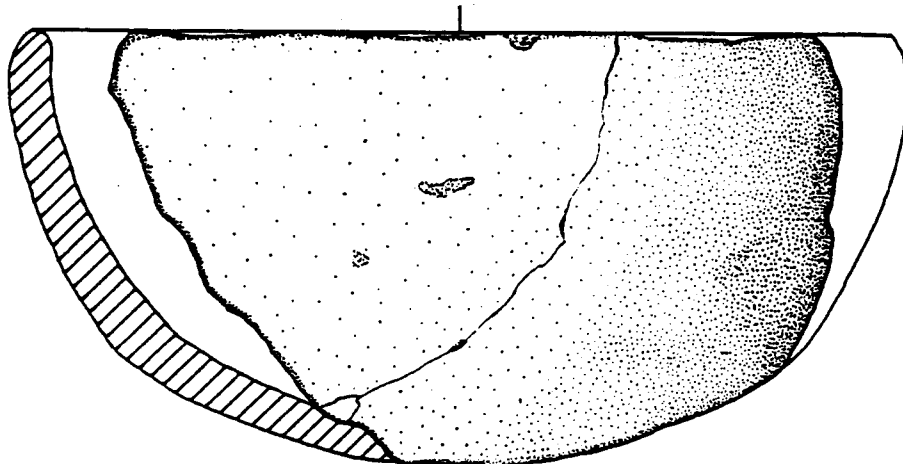

TM 7

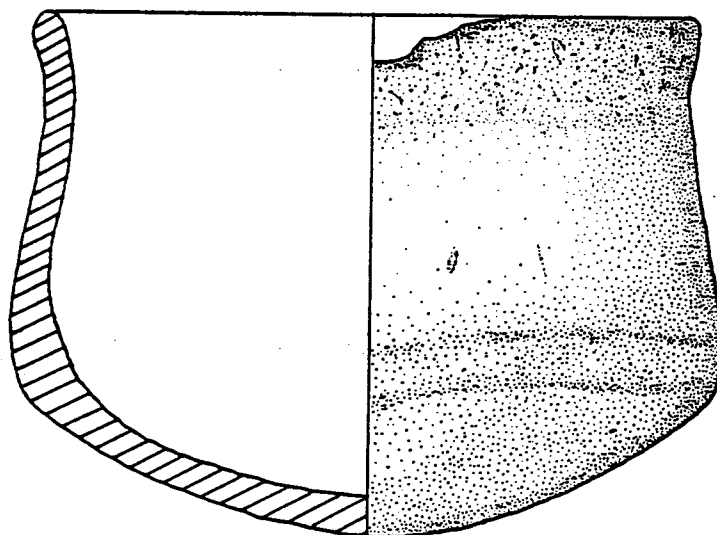

TM 5



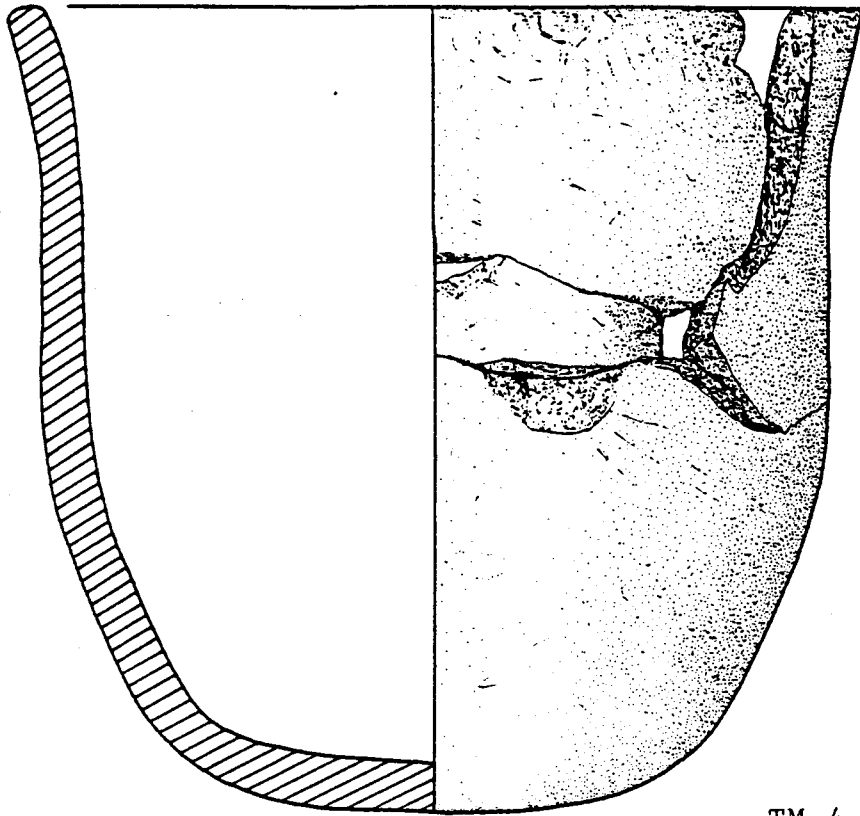

TM 4

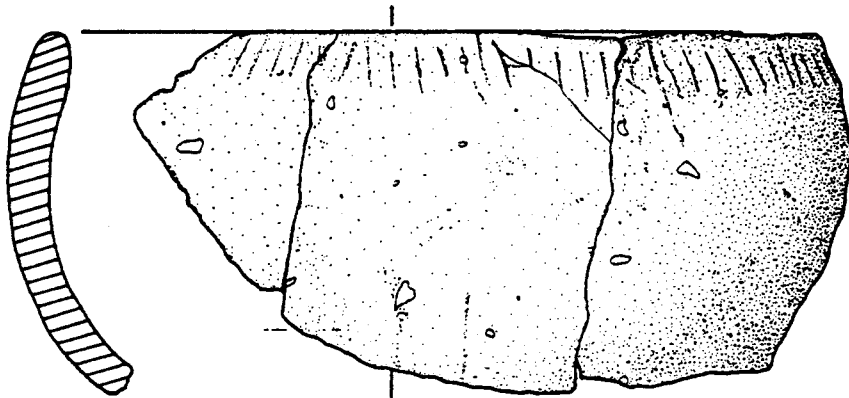

TM 10

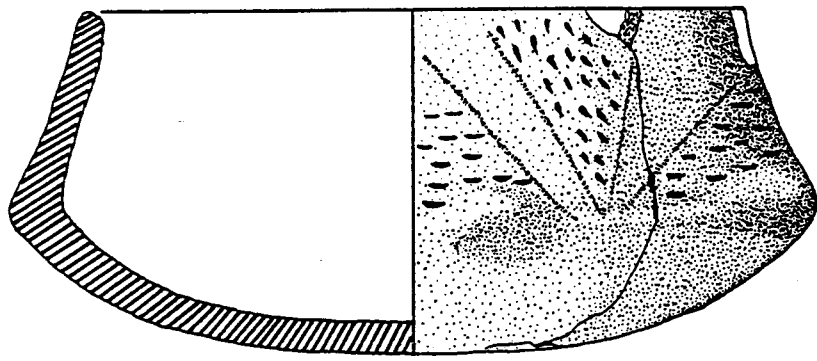

TM 14

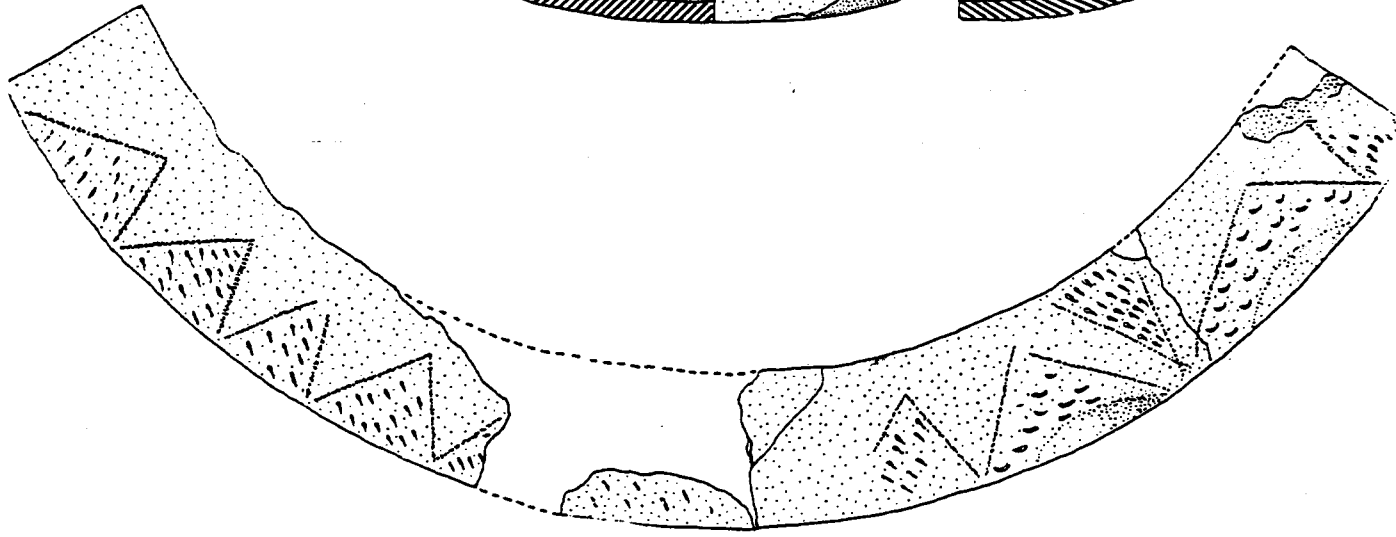
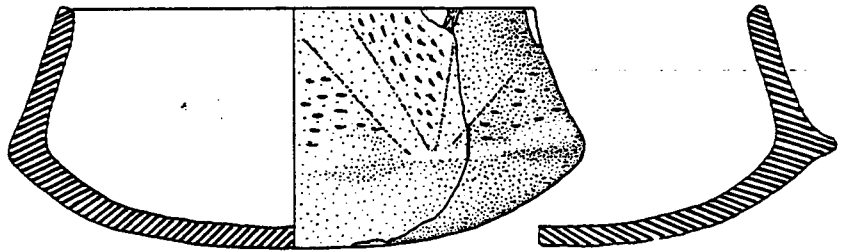

0 4 cm

A horizontal scale bar with a dashed line in the middle, indicating a length of 4 centimeters.

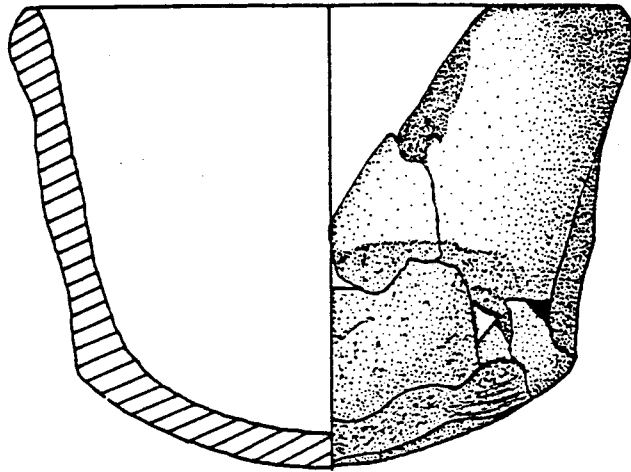

TM 13

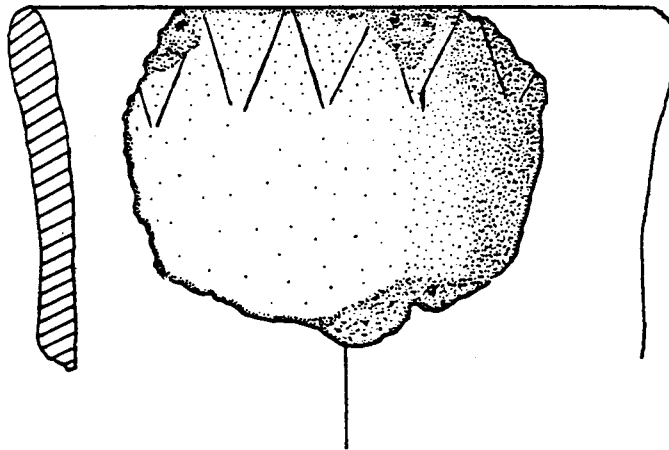

TM 8



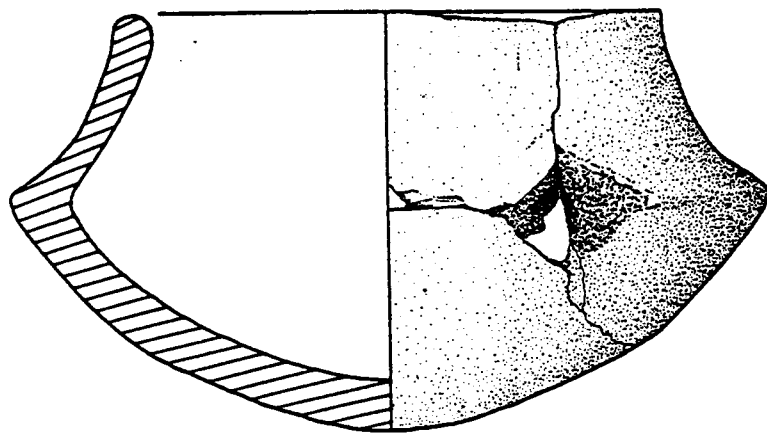

TM 2

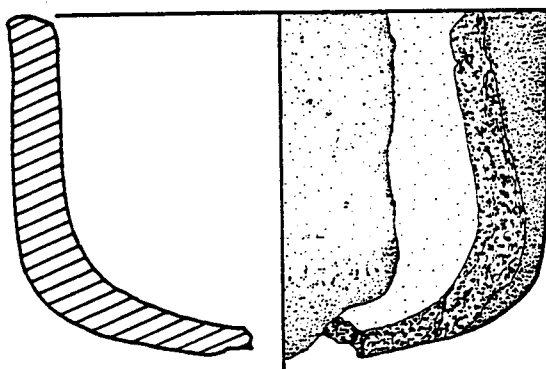

TM 12





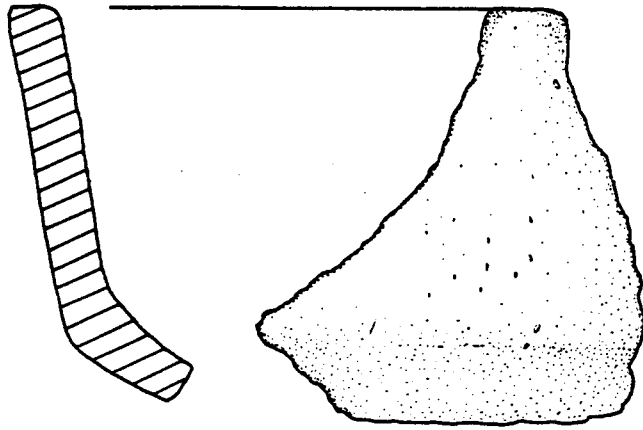

TM 6

0 4 cm

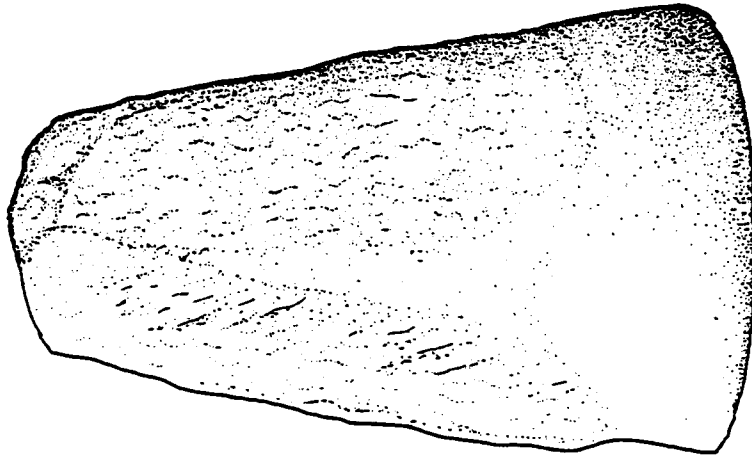

TM 269

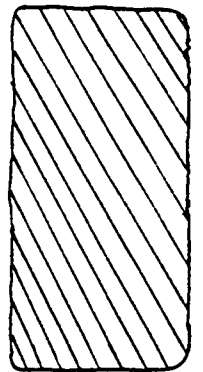
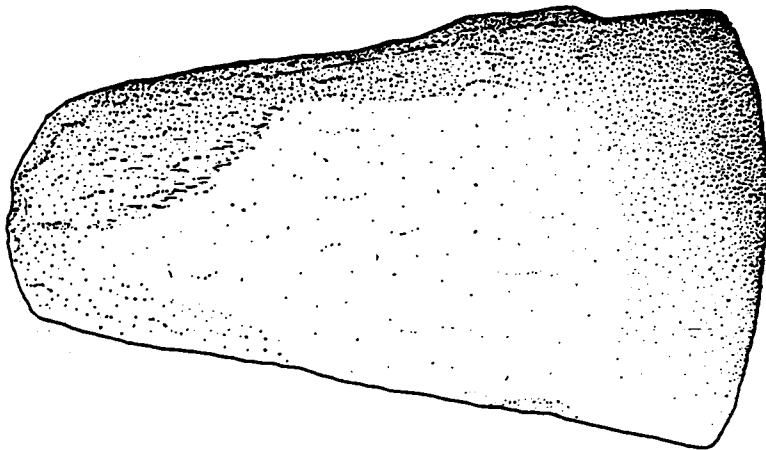
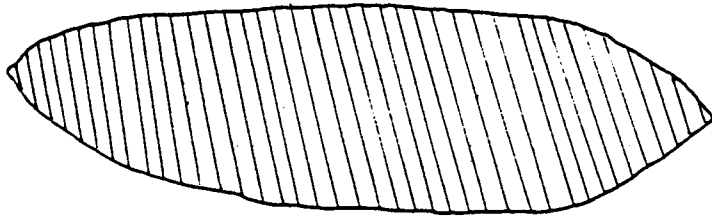

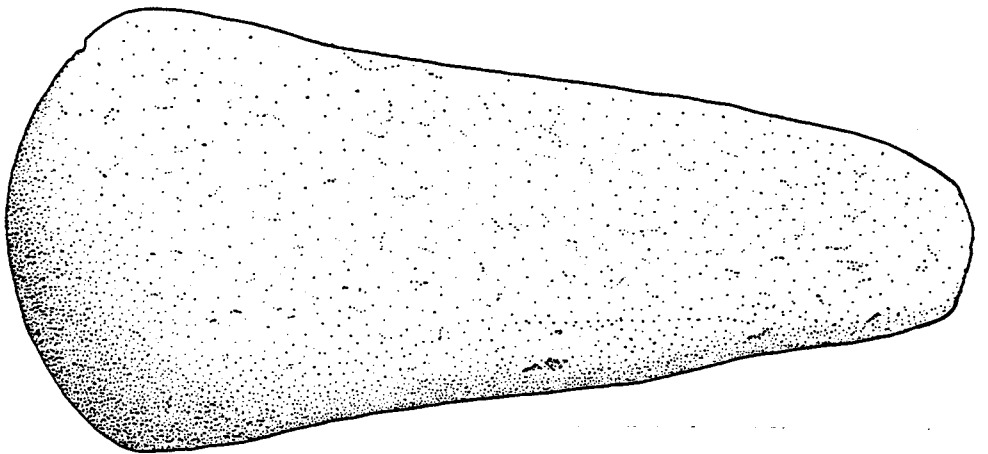
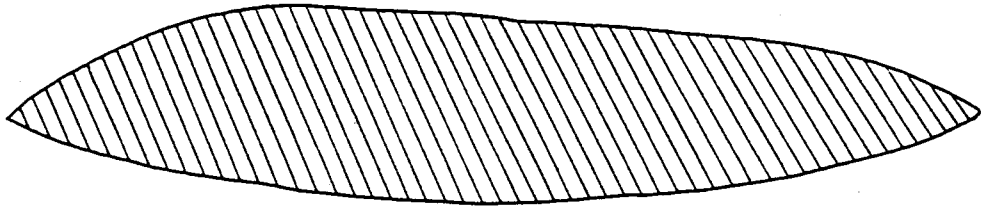
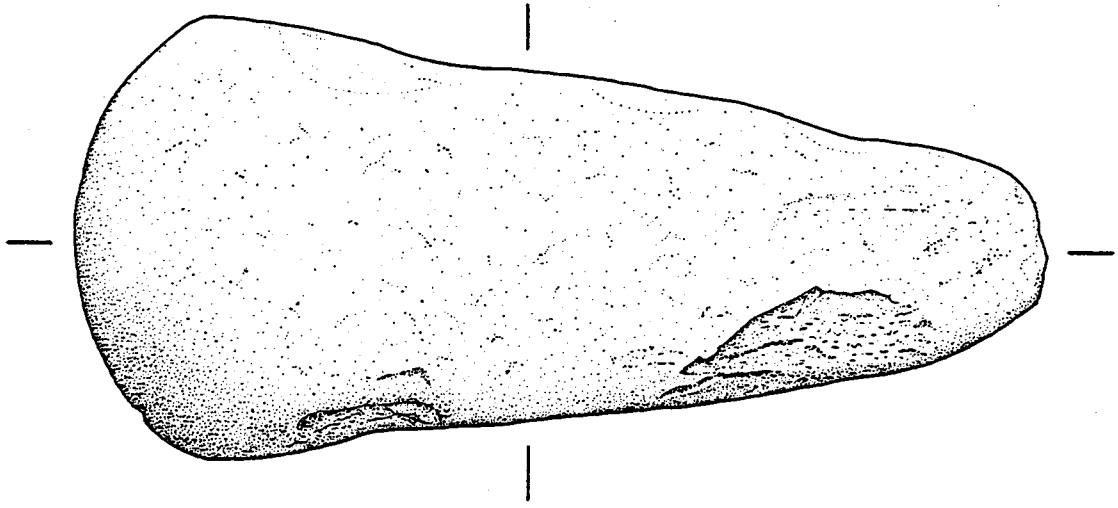
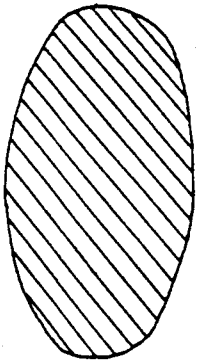

TM 271



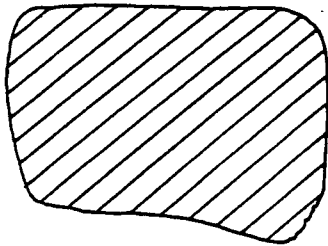
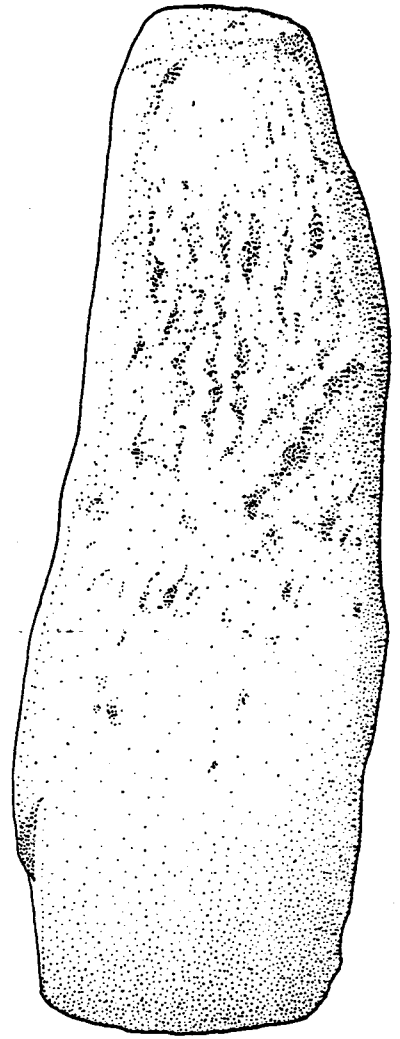
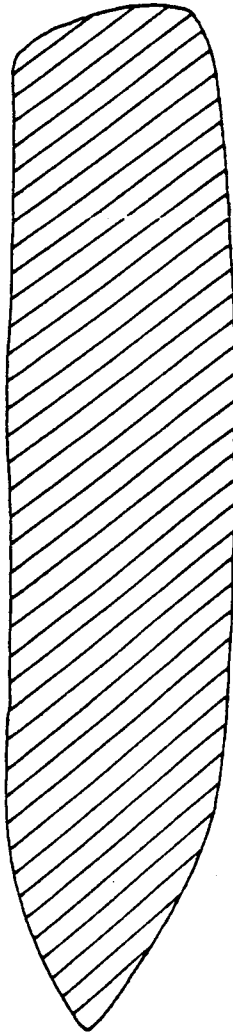
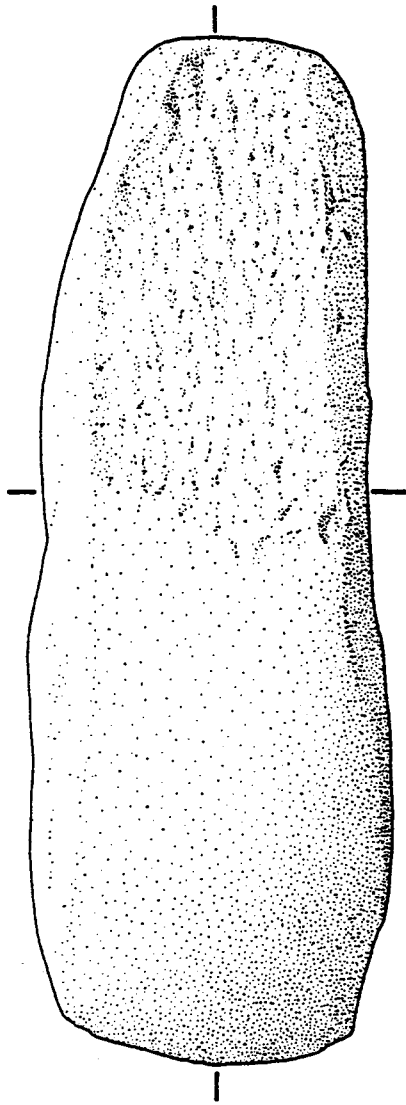

TM 270



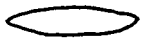
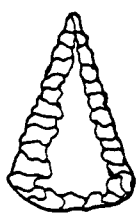

TM 131

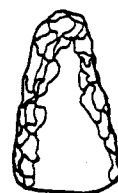
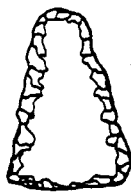

TM 219



TM 148

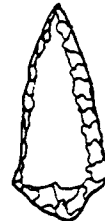

TM 149

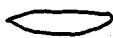

TM 134

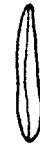

TM 130



TM 218



TM 223

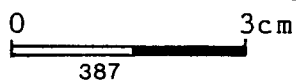

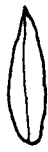

TM 221

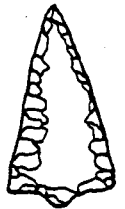

TM 133

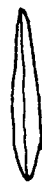

TM 139

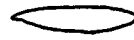
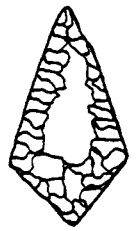
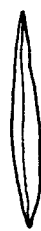

TM 216



TM 217

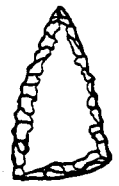
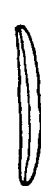

TM 129



TM 150

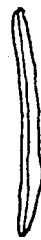

TM 164

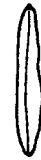

TM 204

TM 151

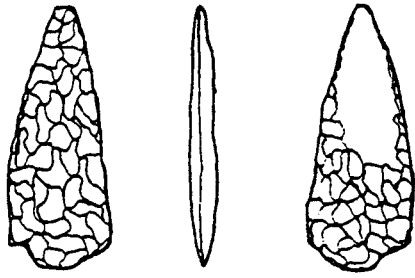

TM 126

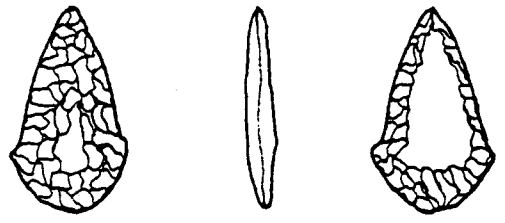

TM 116

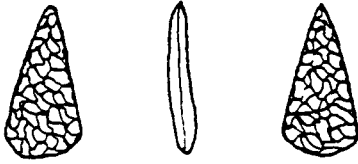

TM 152

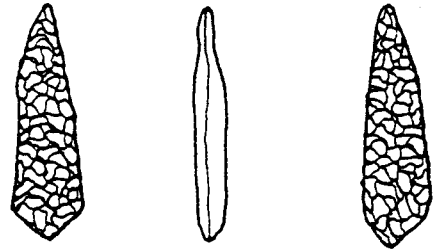

TM 153



TM 222



TM 132

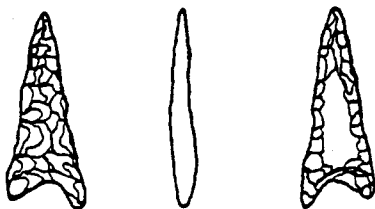

TM 141

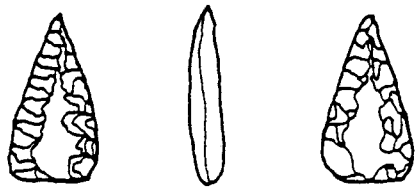

TM 215



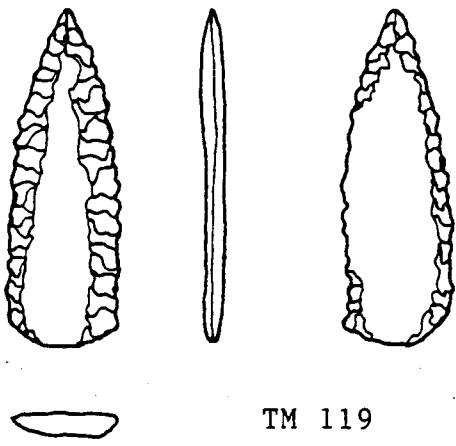

TM 119

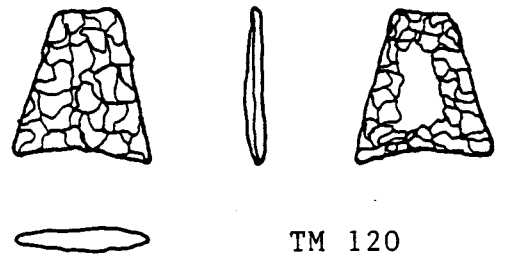

TM 120

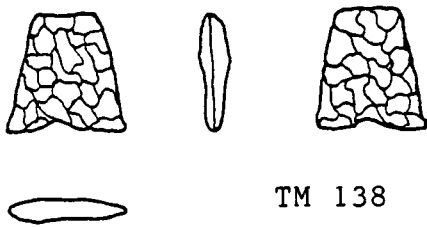

TM 138

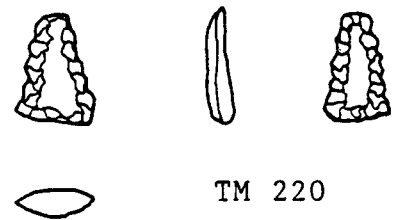

TM 220

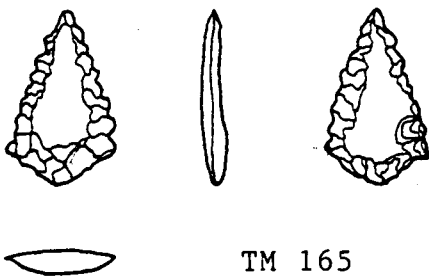

TM 165

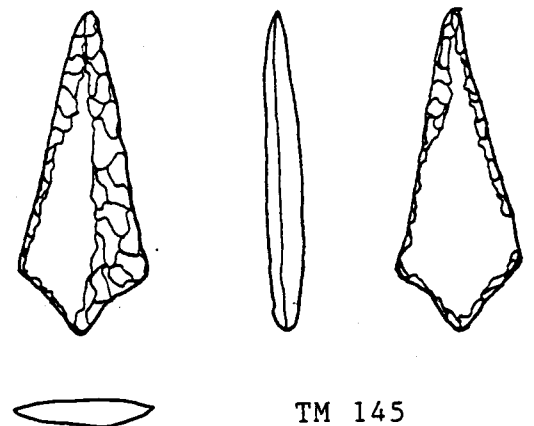

TM 145

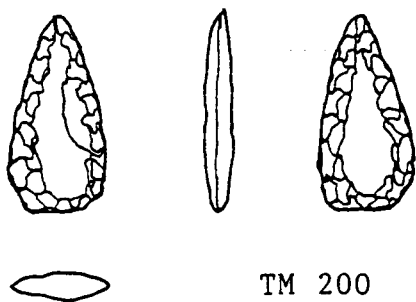

TM 200

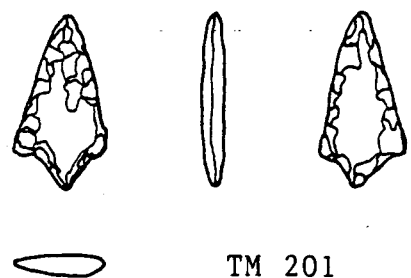

TM 201





TM 118

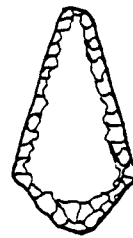

TM 202

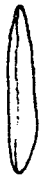

TM 117

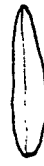

TM 140



TM 224

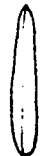

TM 203

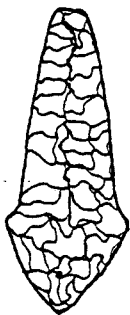

TM 115

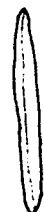

TM 151



TM 125

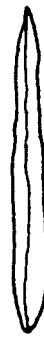

TM 142

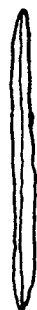

TM 154



TM 146

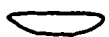
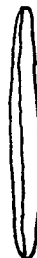

TM 113



TM 114

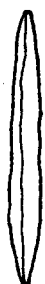
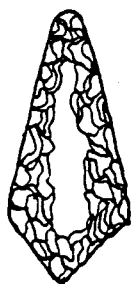

TM 169



TM 112



TM 199

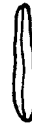

TM 263

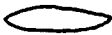
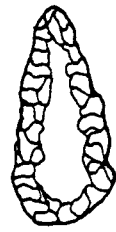
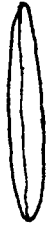

TM 137



TM 226



TM 112

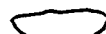
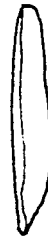

TM 127

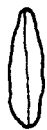

TM 168

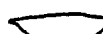
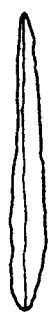

TM 121





TM 208



TM 170

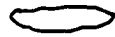

TM 198



TM 197

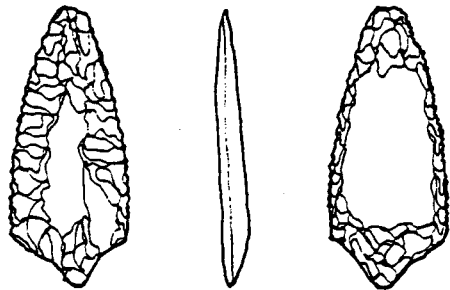

TM 155

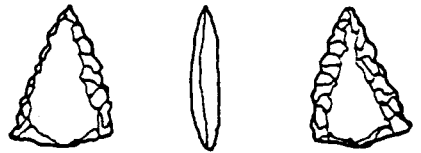

TM 136

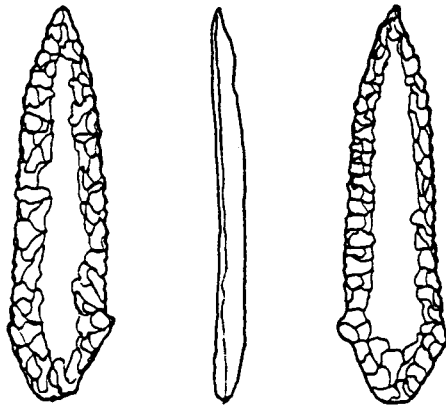

TM 514

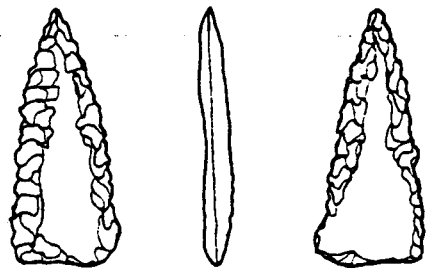

TM 185

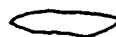

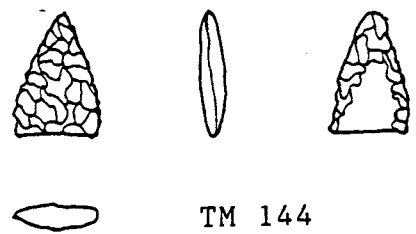
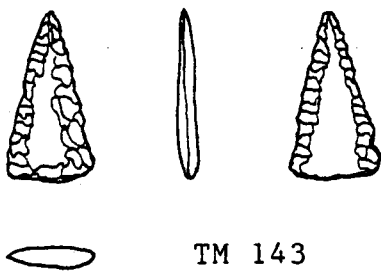
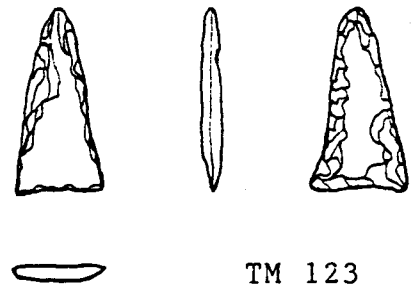
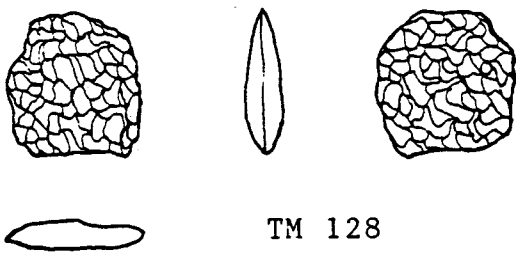
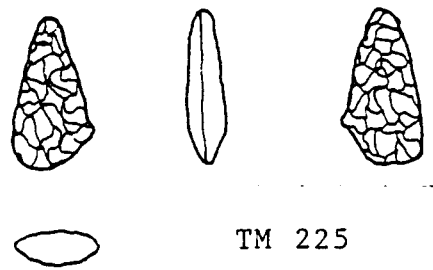
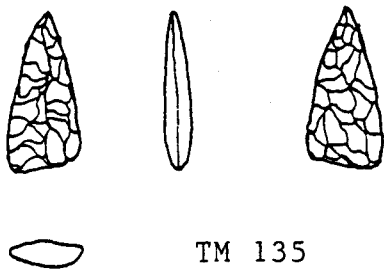
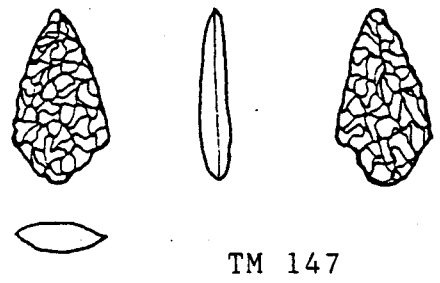
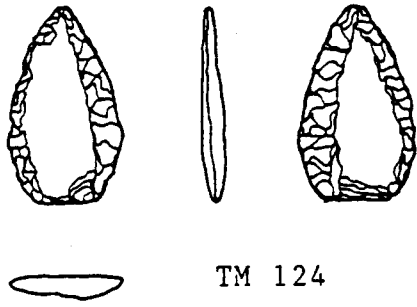

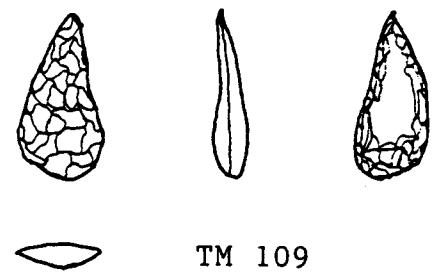
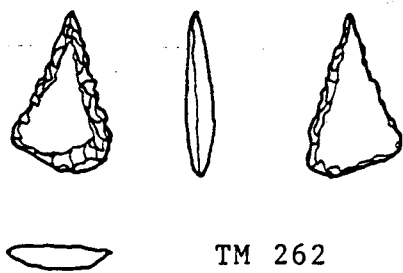
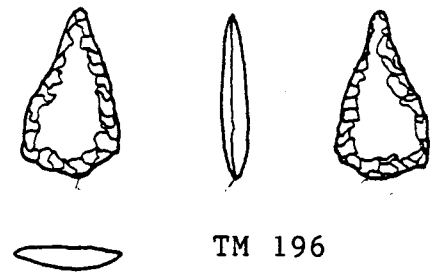
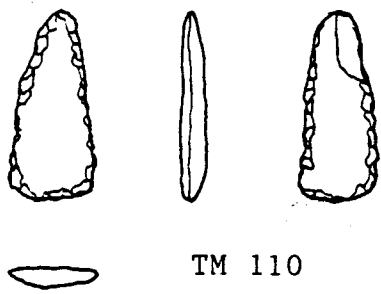
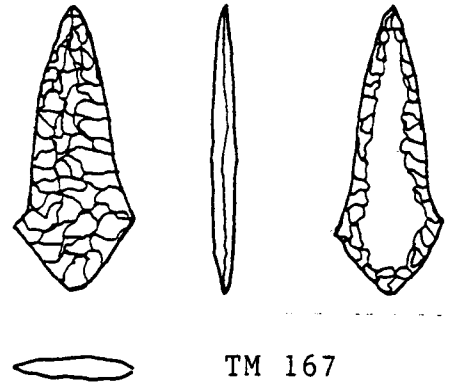
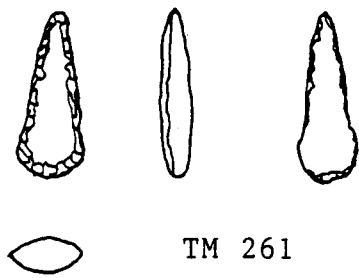
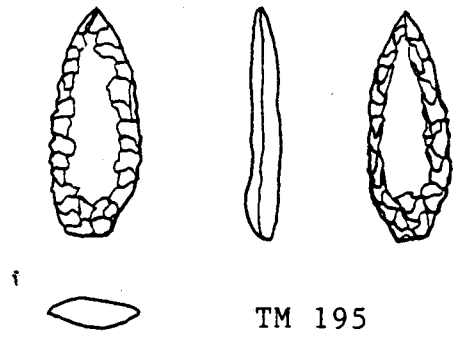
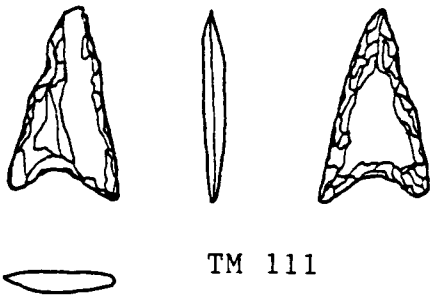

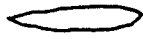
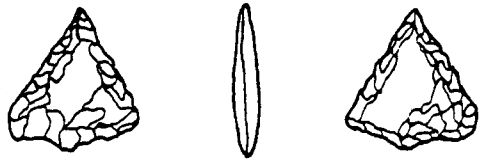

TM 107

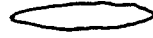
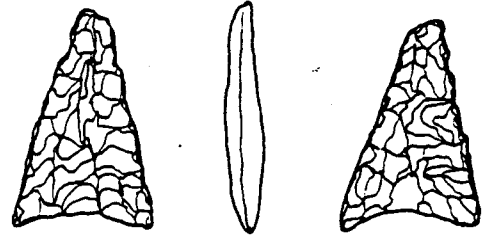

TM 189

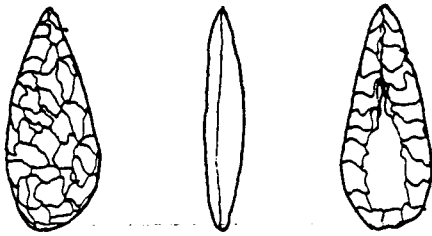

TM 188

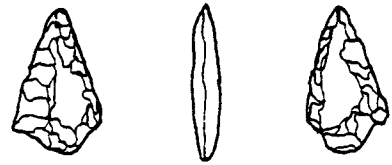

TM 187

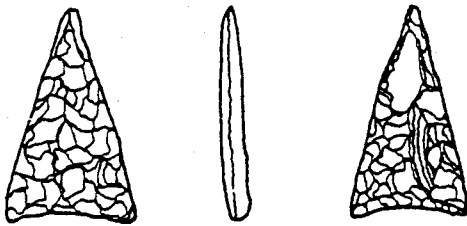

TM 186

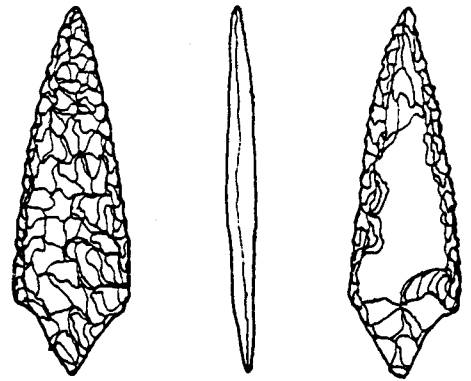

TM 259

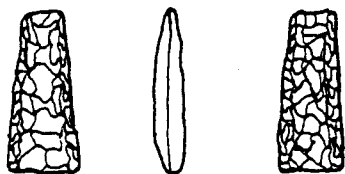

TM 260

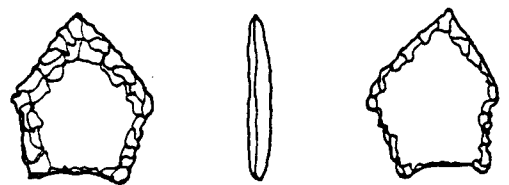

TM 163

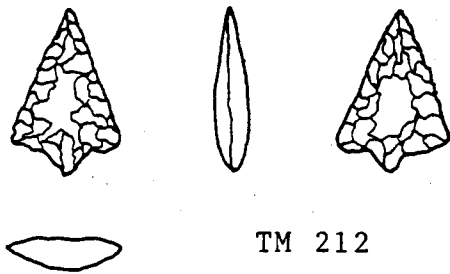

TM 212

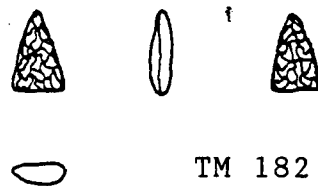

TM 182

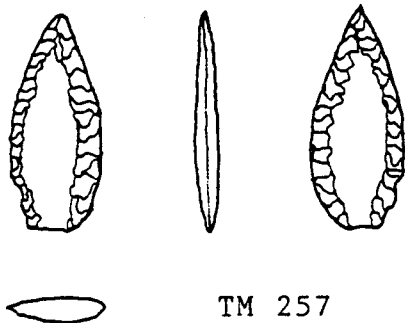

TM 257

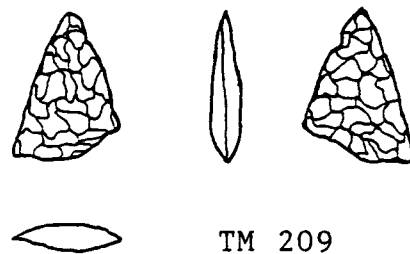

TM 209

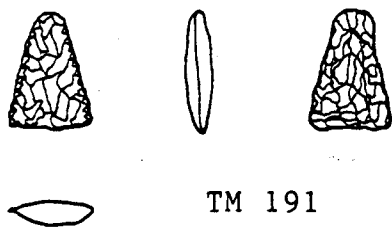

TM 191

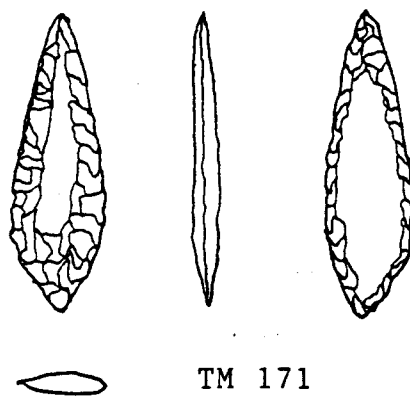

TM 171

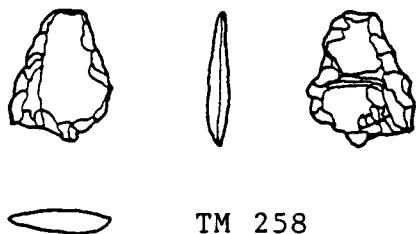

TM 258

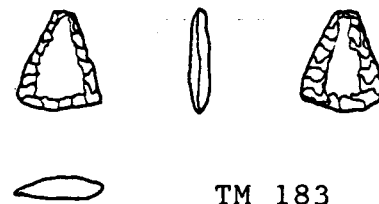

TM 183





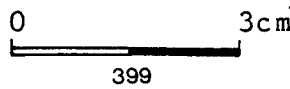
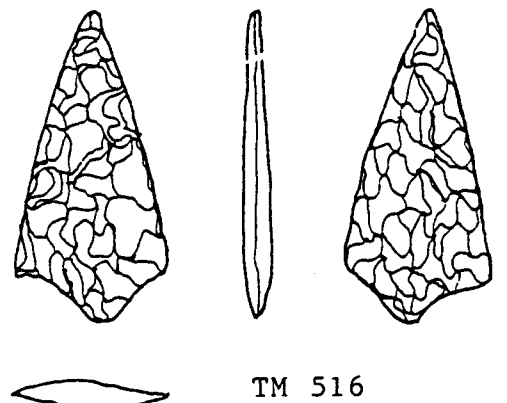
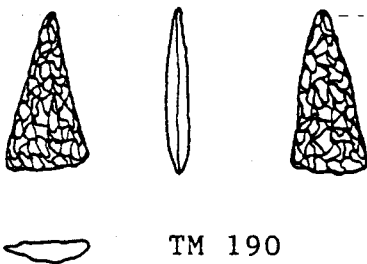
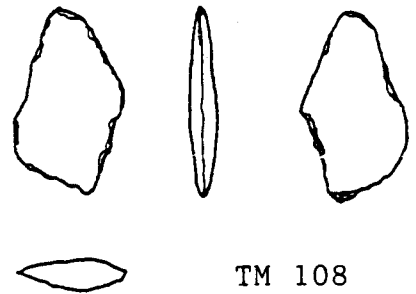
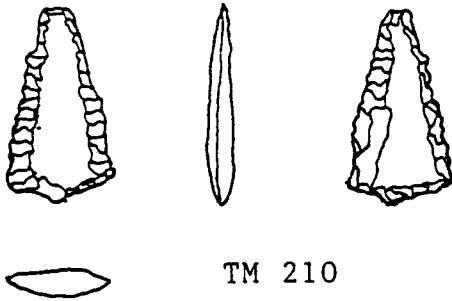
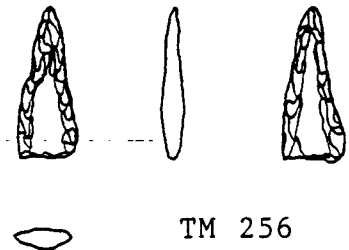
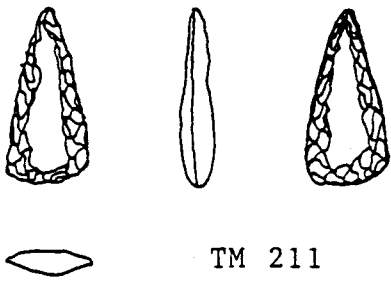
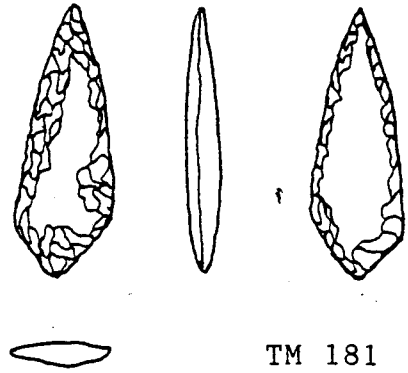
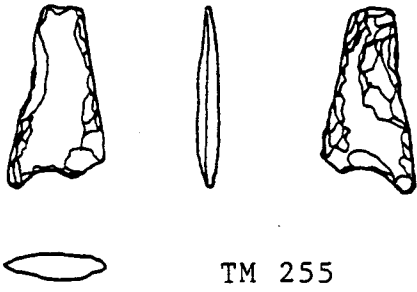

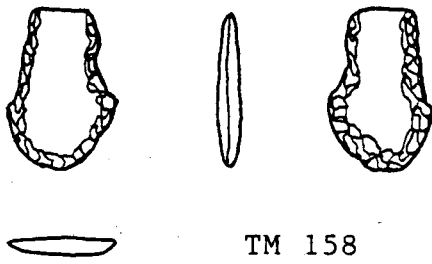

TM 158

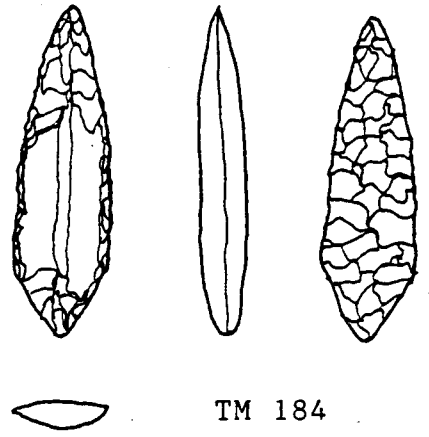

TM 184

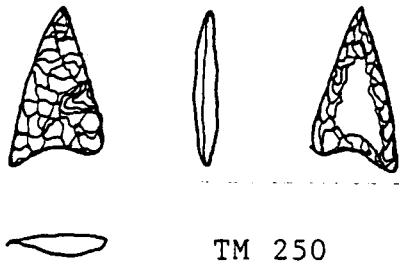

TM 250

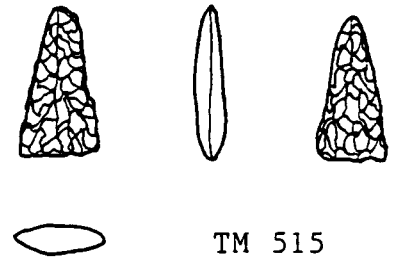

TM 515

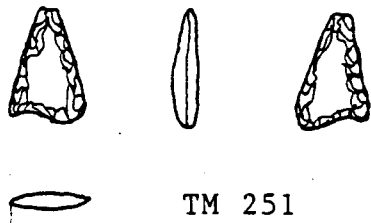

TM 251

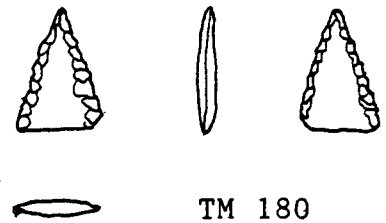

TM 180

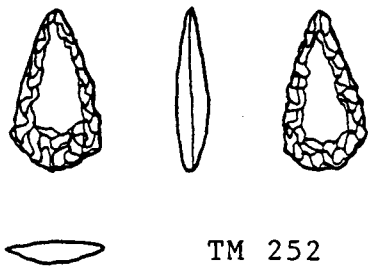

TM 252

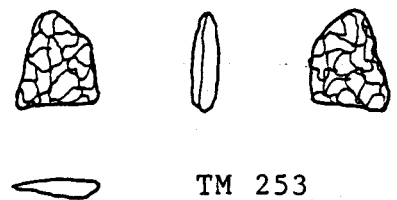

TM 253



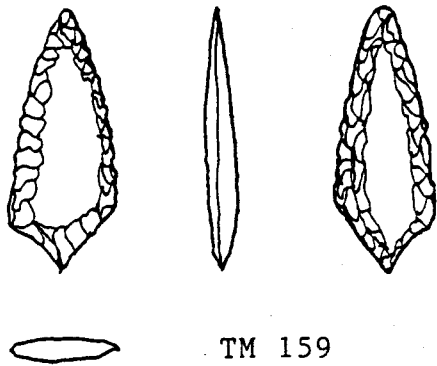

TM 159

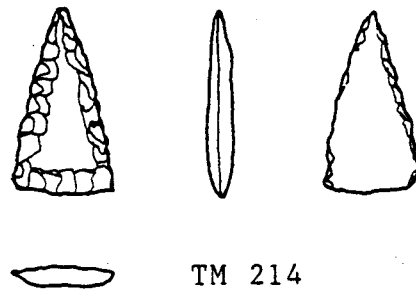

TM 214

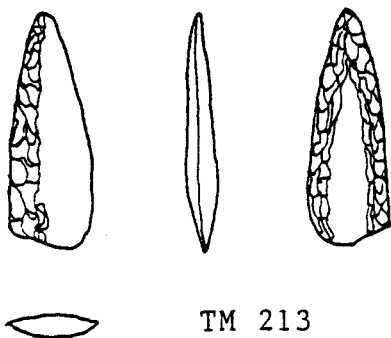

TM 213

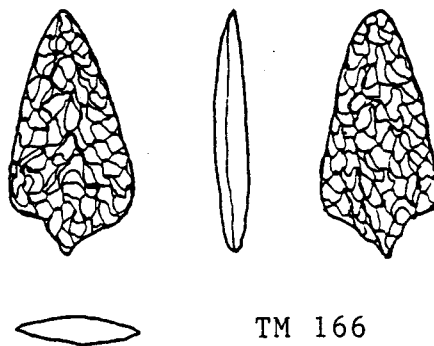

TM 166

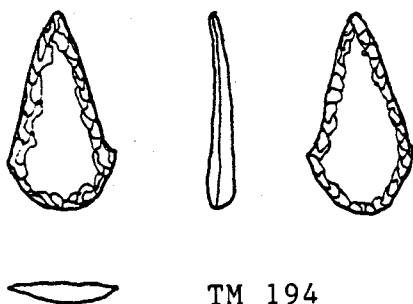

TM 194

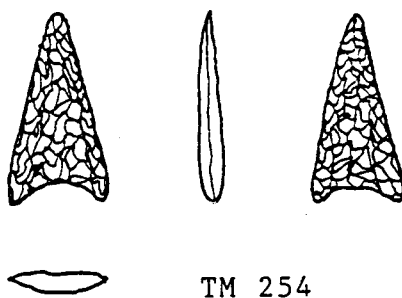

TM 254

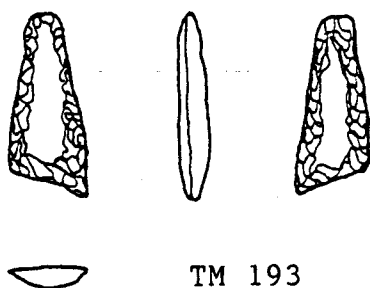

TM 193

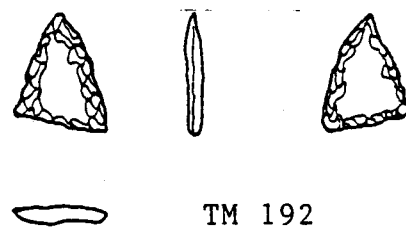

TM 192

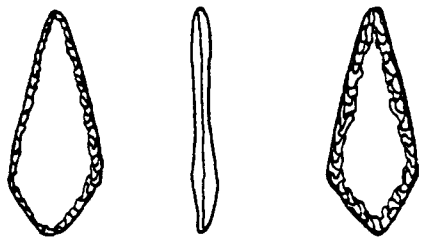

TM 157

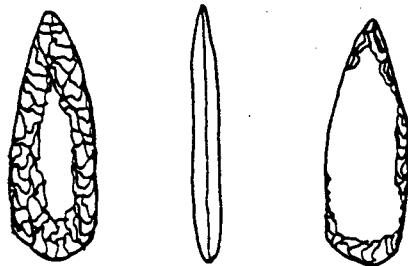

TM 241

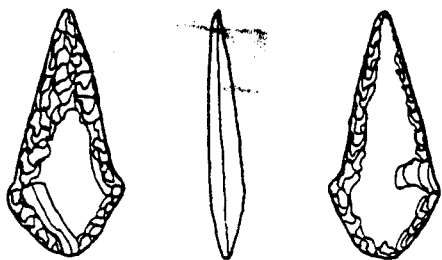

TM 160

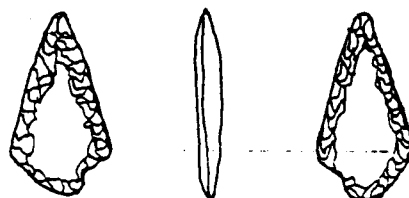

TM 161

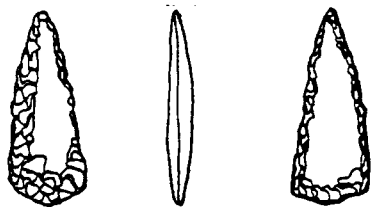

TM 242



TM 243

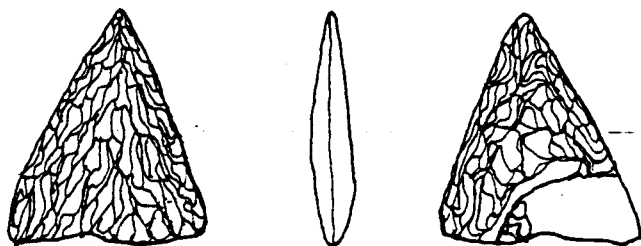

TM 513

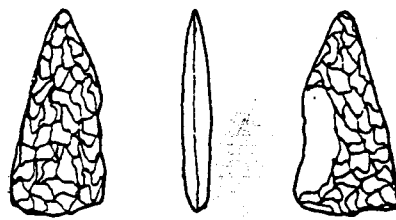

TM 244



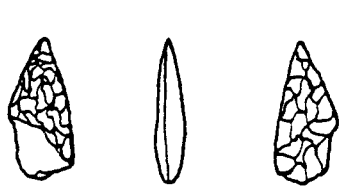

TM 244

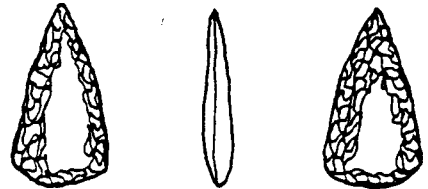

TM 245



TM 246

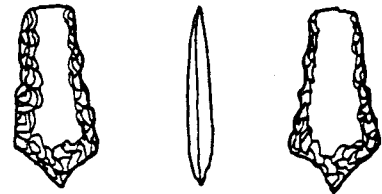

TM 247

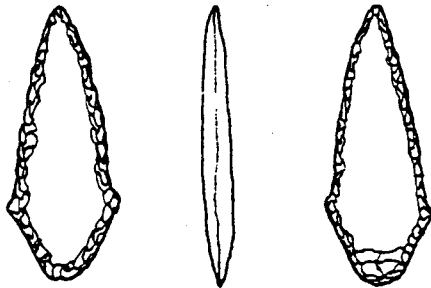

TM 162

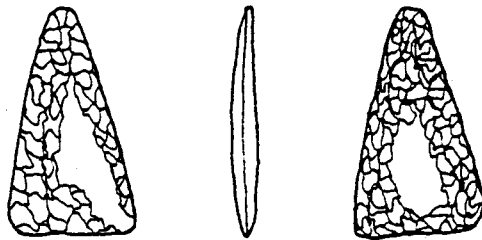
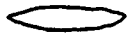

TM 179

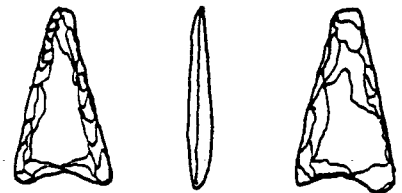
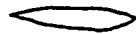

TM 249



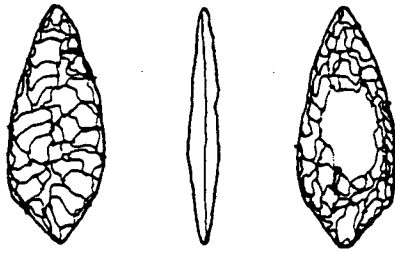

TM 239

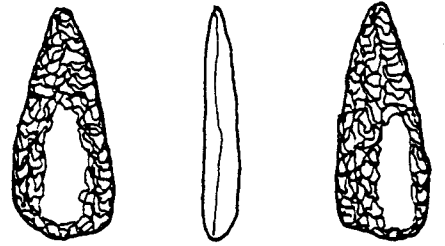

TM 173

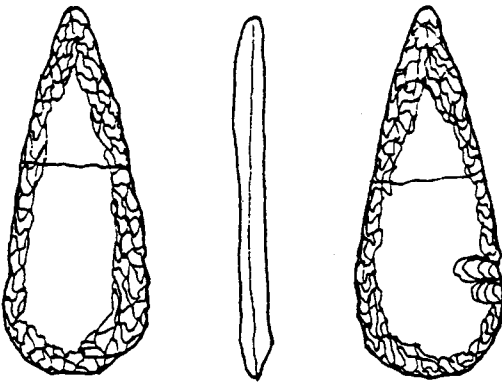

TM 511

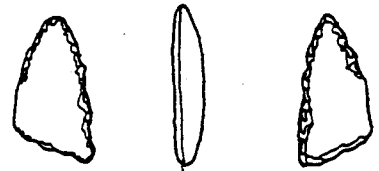

TM 240

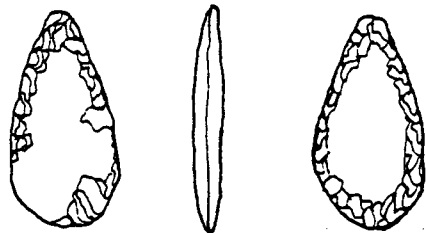

TM 512

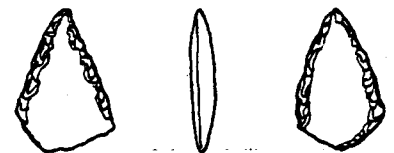

TM 178



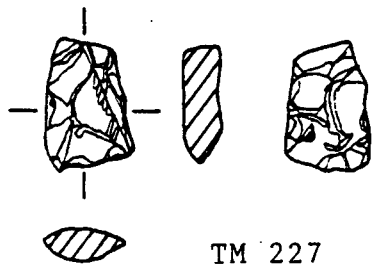

TM 227

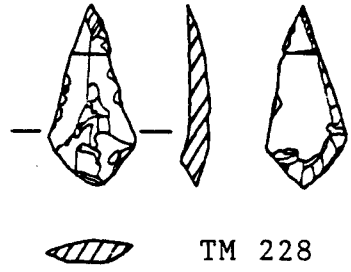

TM 228

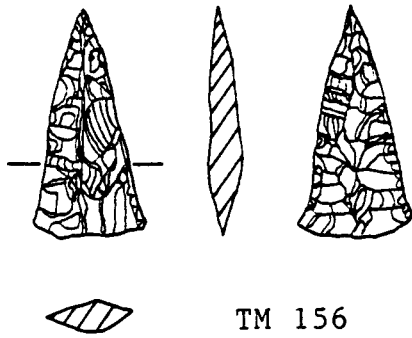

TM 156

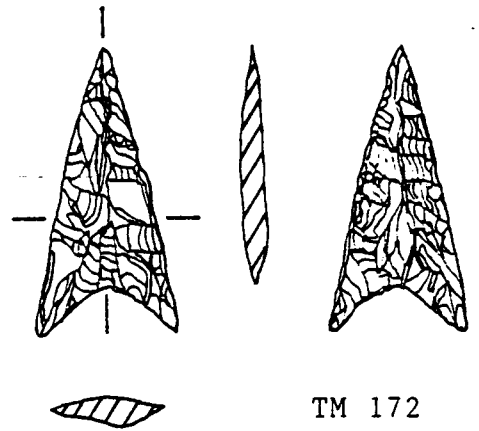

TM 172

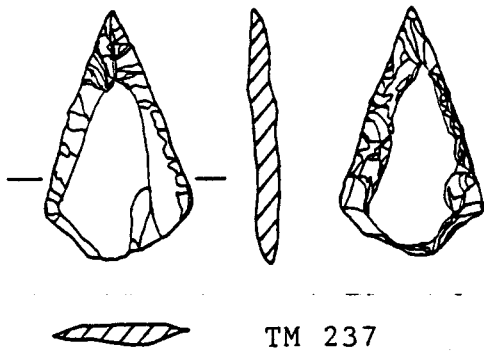

TM 237

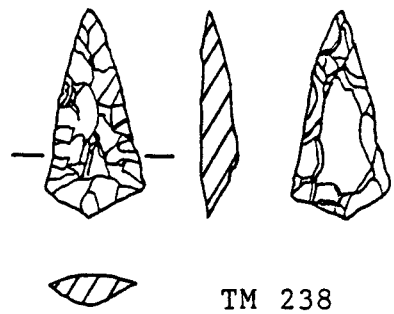

TM 238



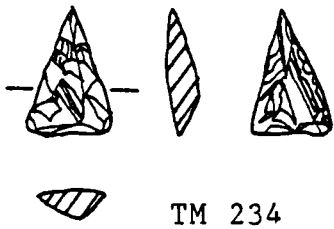

TM 234

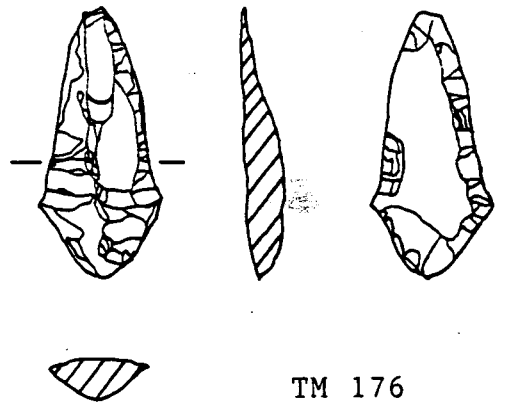

TM 176

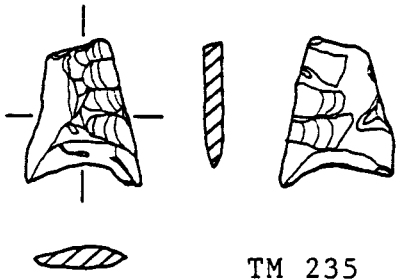

TM 235

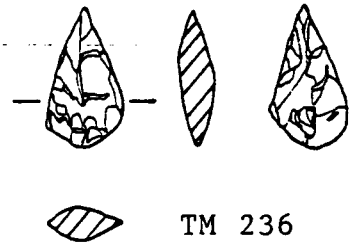

TM 236

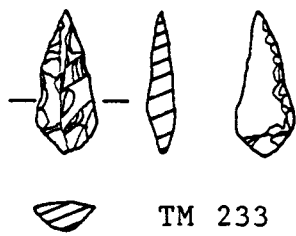

TM 233

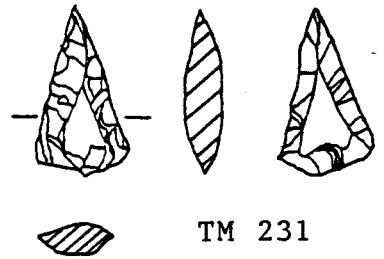

TM 231





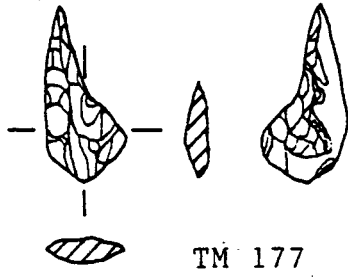

TM 177

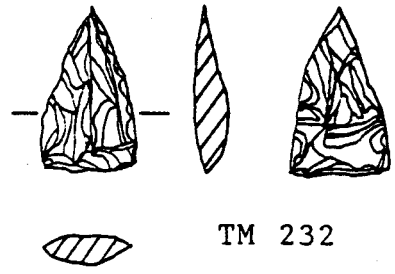

TM 232

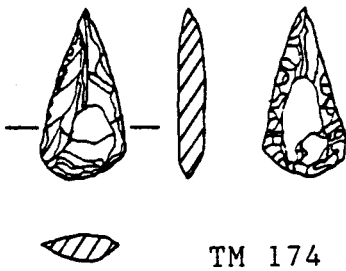

TM 174

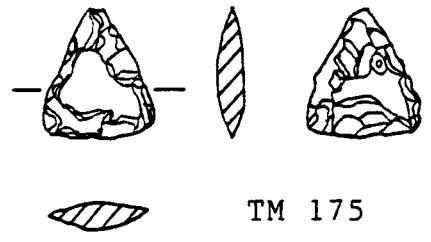

TM 175



TM 230



TM 229



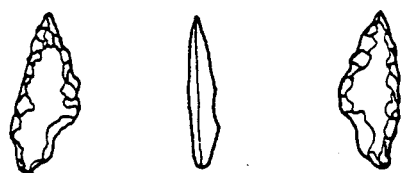

TM 205



TM 150

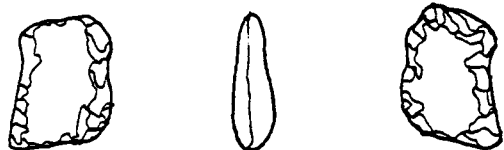

TM 206



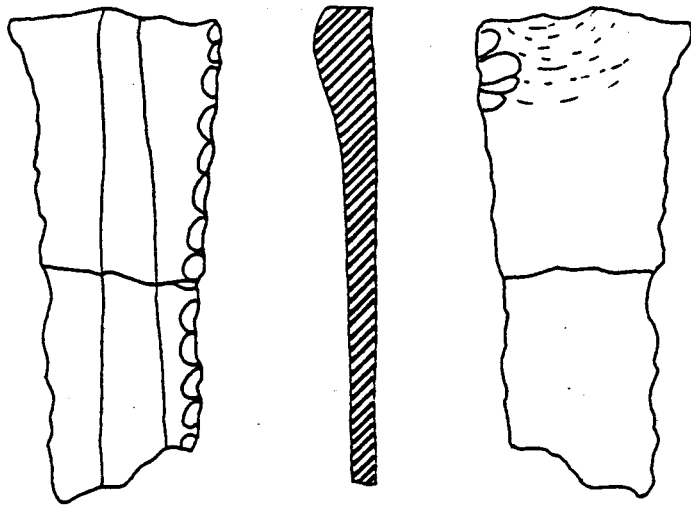

TM 73

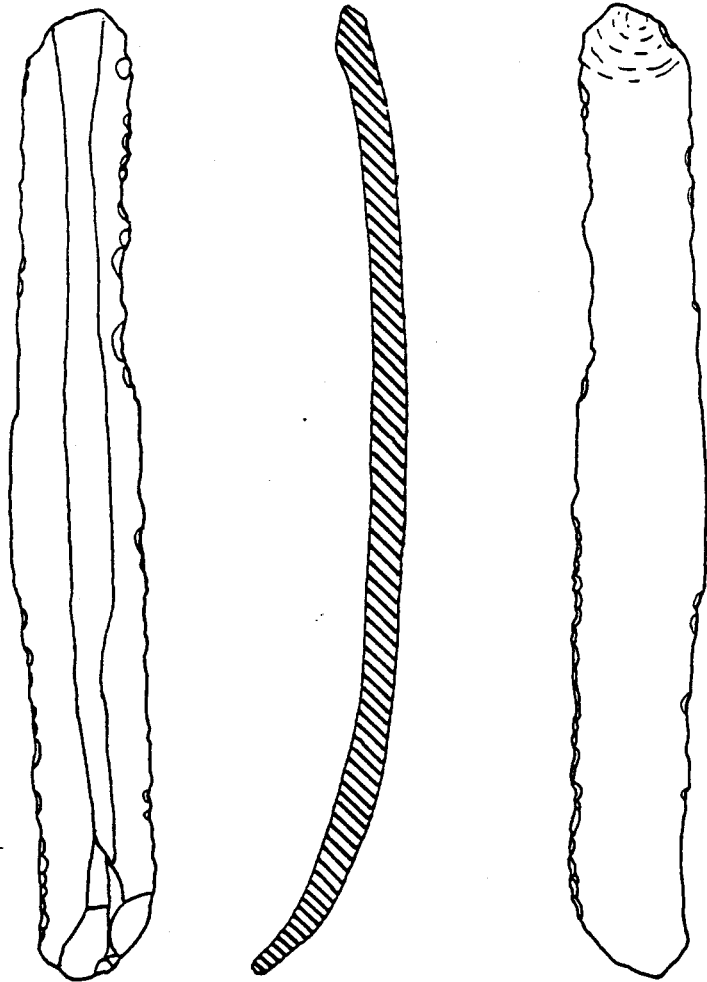

TM 106



409

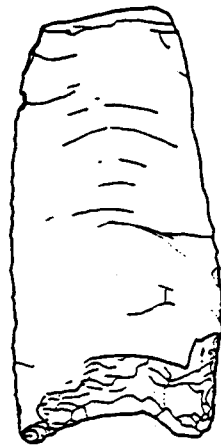
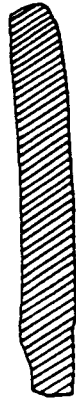
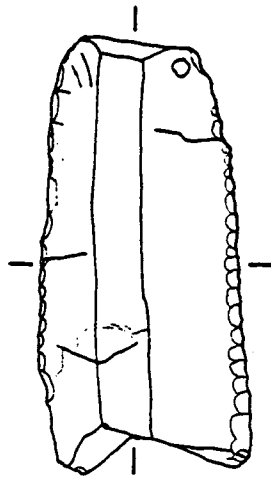

TM 79

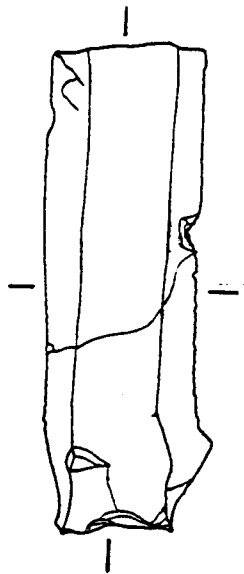

TM 75

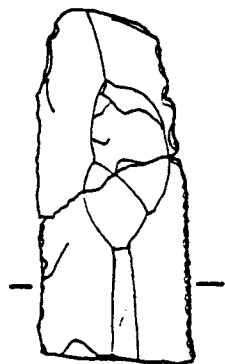

TM 83  
410



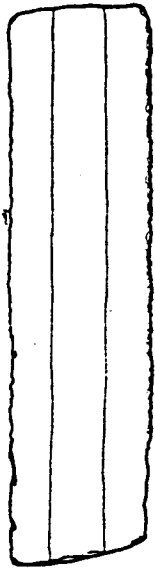

TM 78

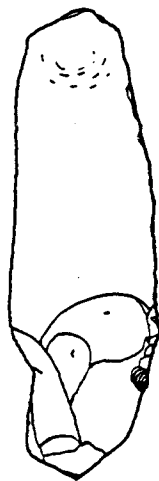
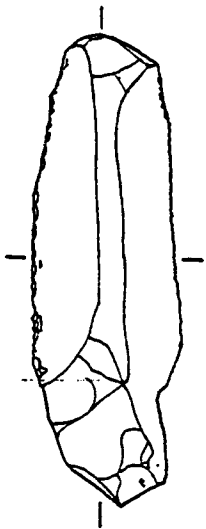

TM 74



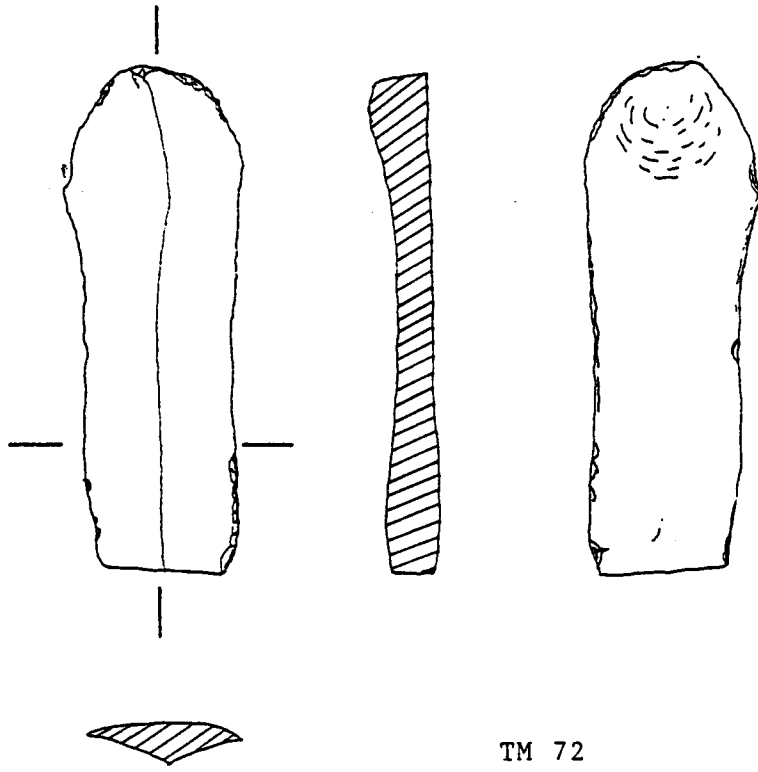

TM 72

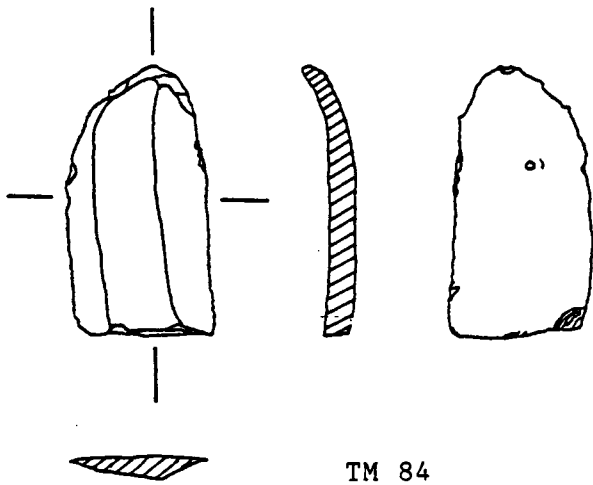

TM 84

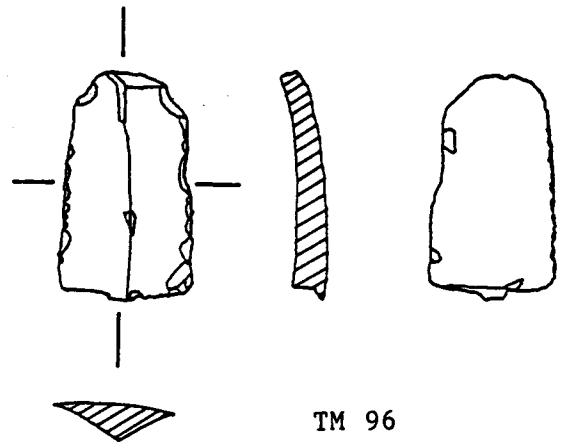

TM 96



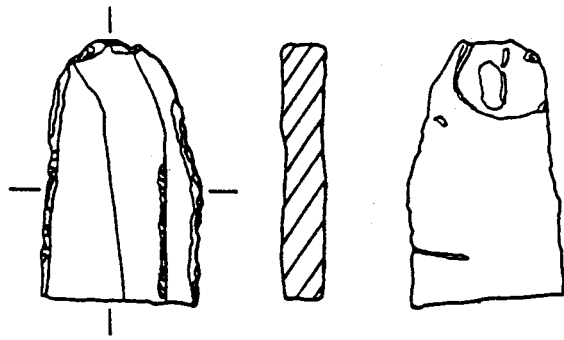

TM 88

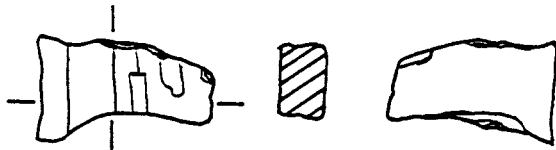

TM 61

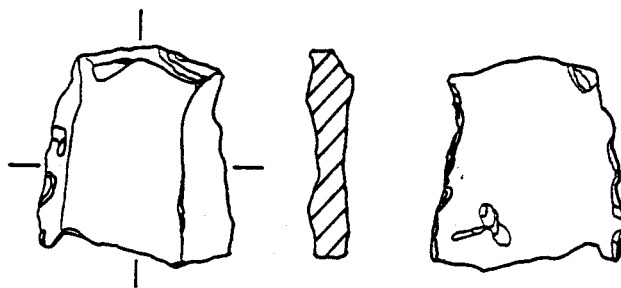

TM 93

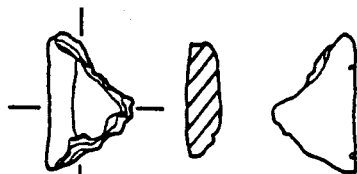

TM 62

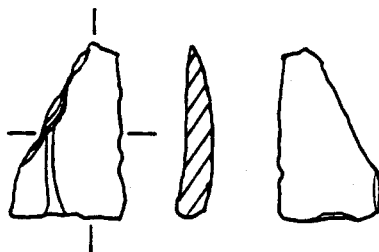

TM 68



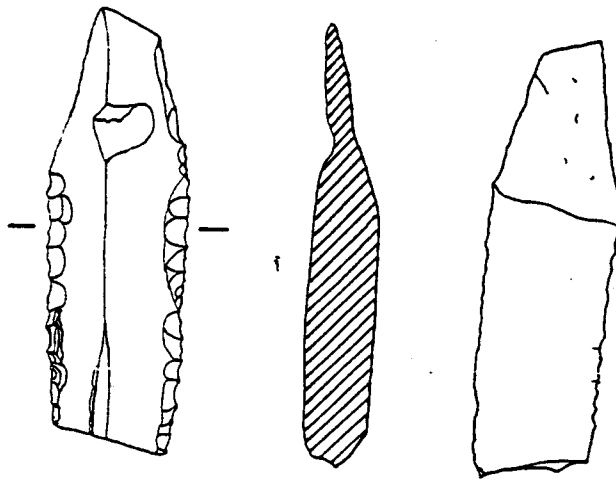

TM 99

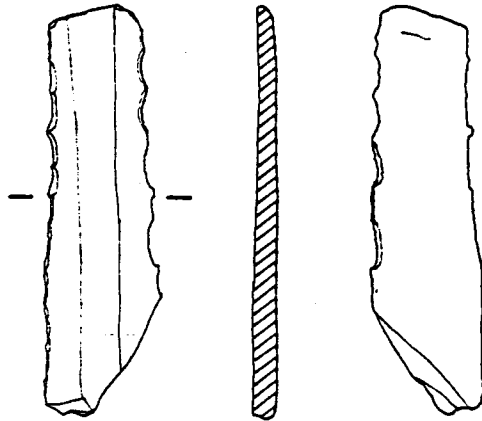

TM 76

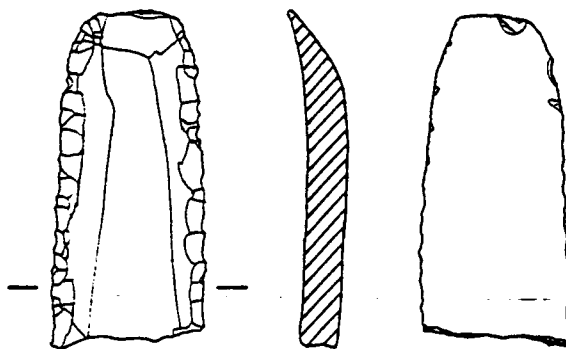

TM 86





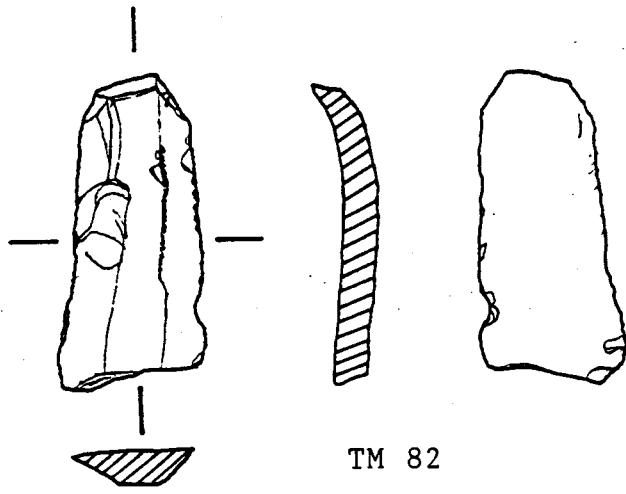

TM 82

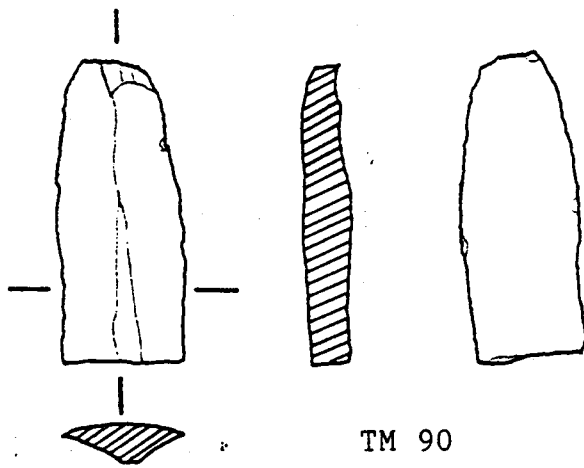

TM 90

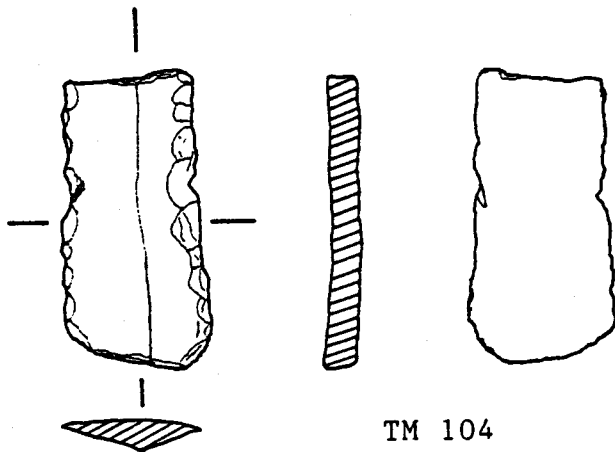

TM 104



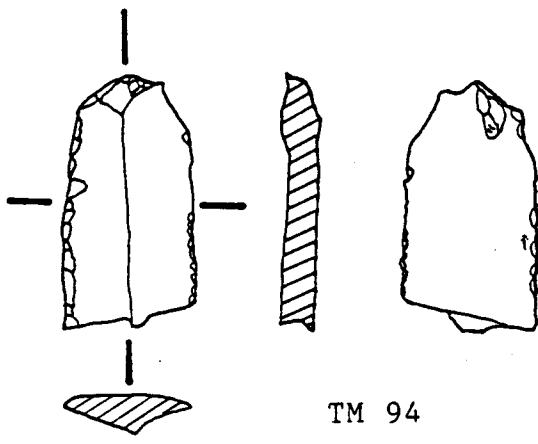

TM 94

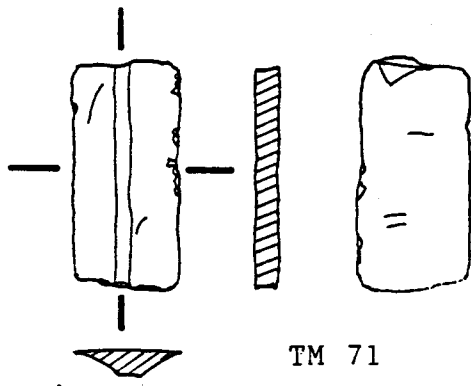

TM 71

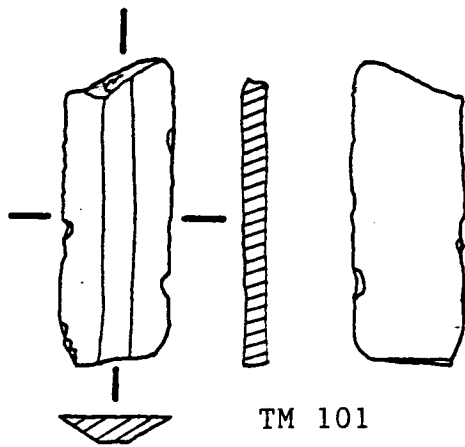

TM 101



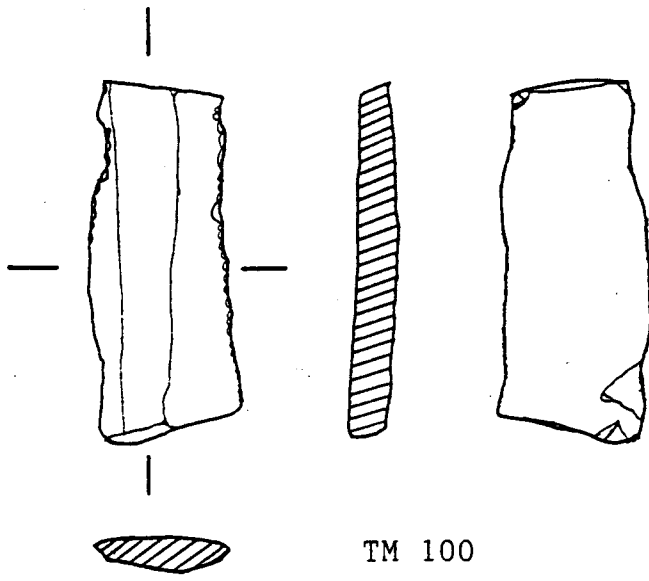

TM 100

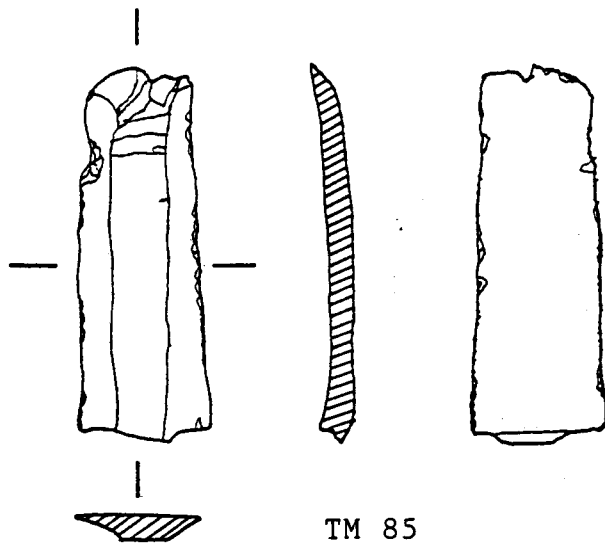

TM 85

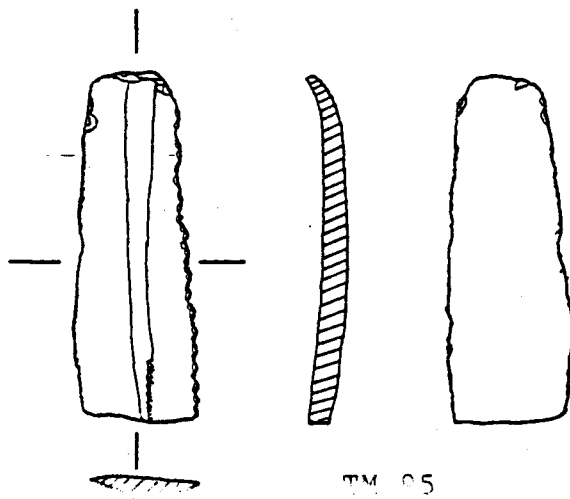

TM 95  
417

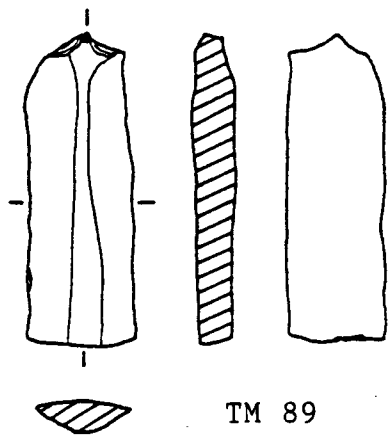

TM 89

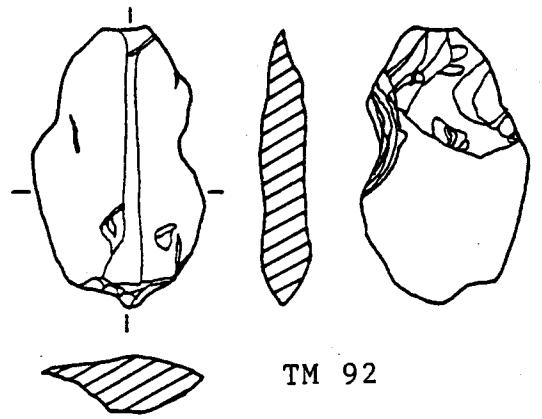

TM 92

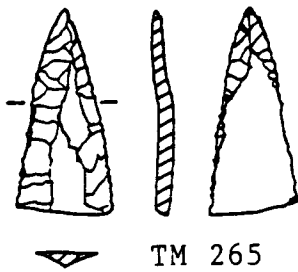

TM 265

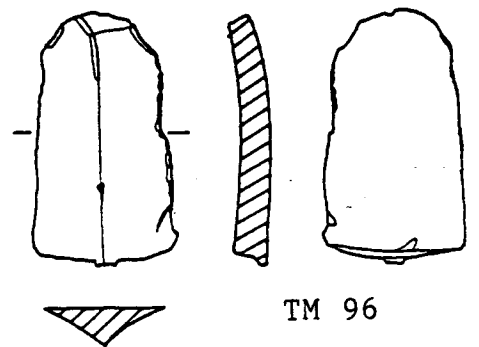

TM 96

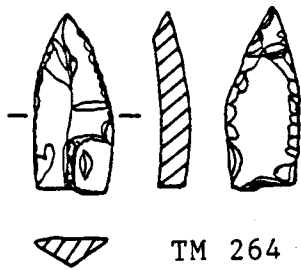

TM 264

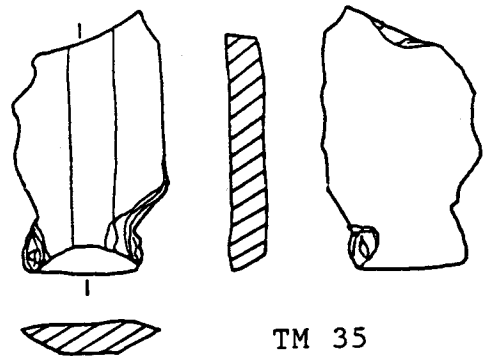

TM 35

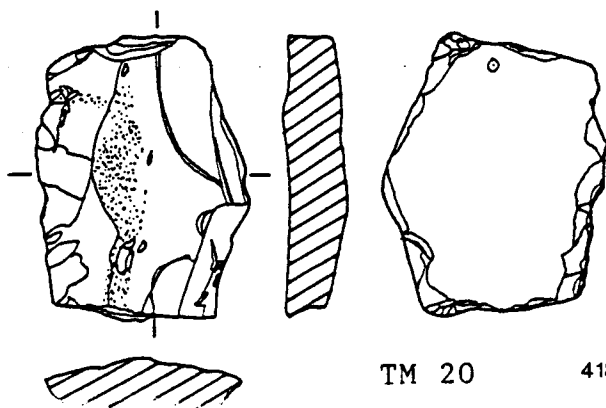

TM 20

418

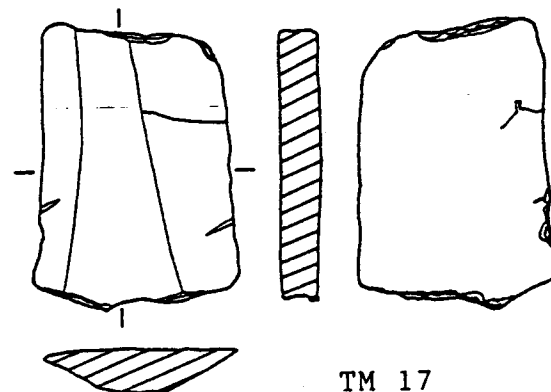

TM 17

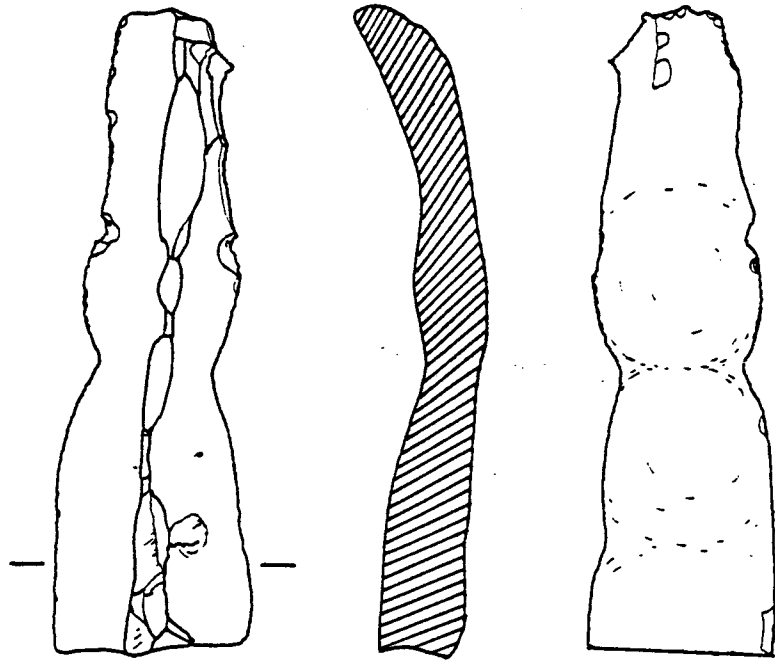

TM 15

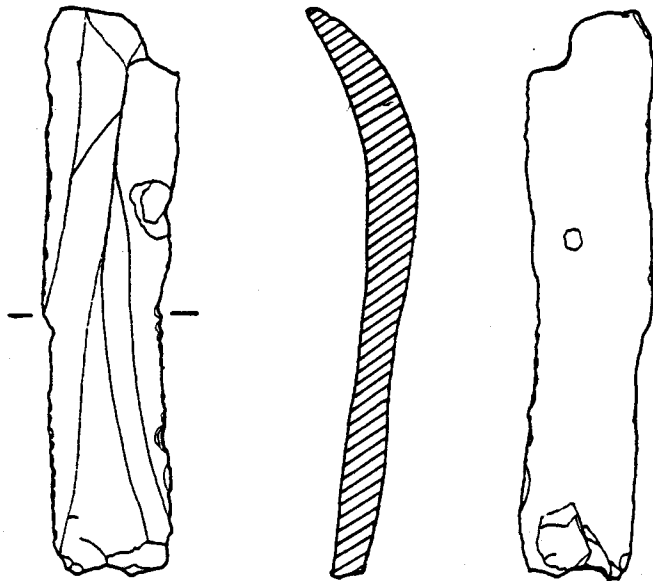

TM 81



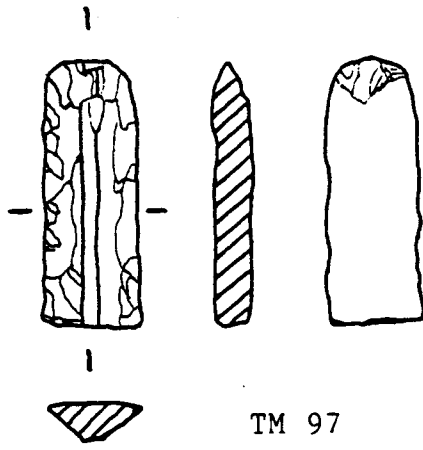

TM 97

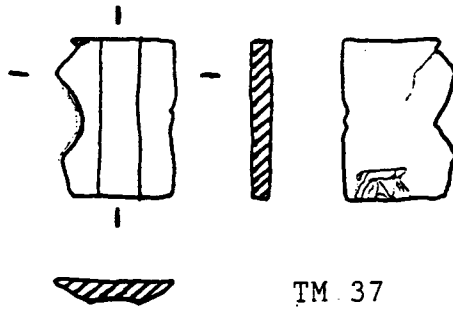

TM 37

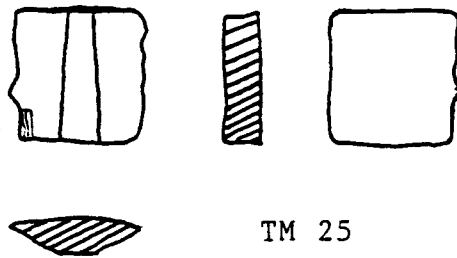

TM 25



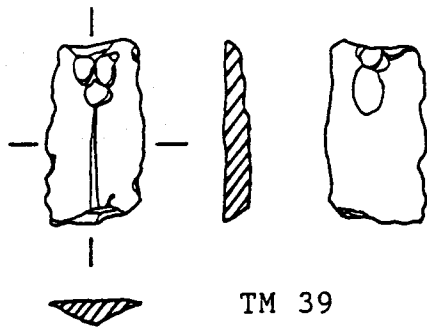

TM 39

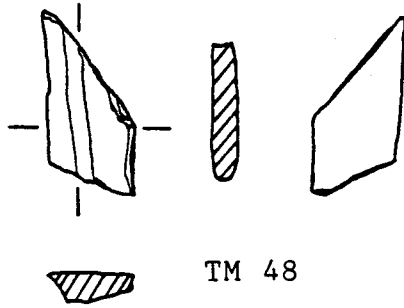

TM 48

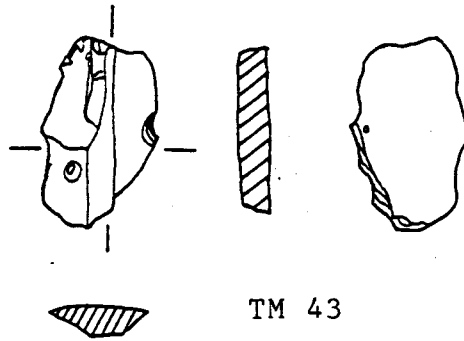

TM 43

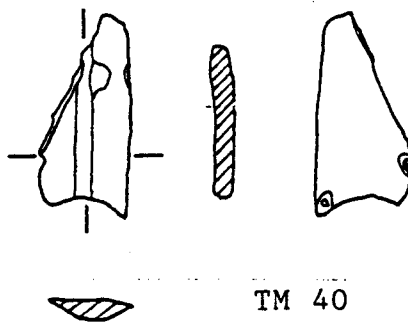

TM 40



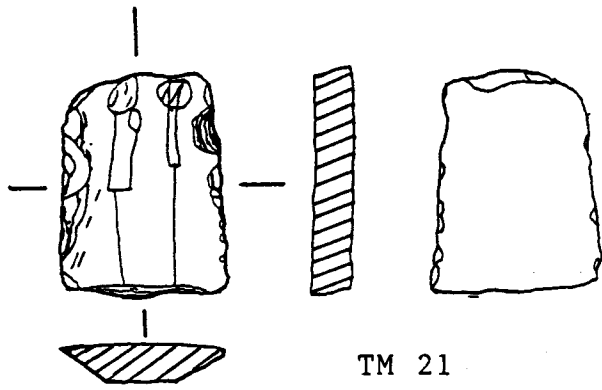

TM 21

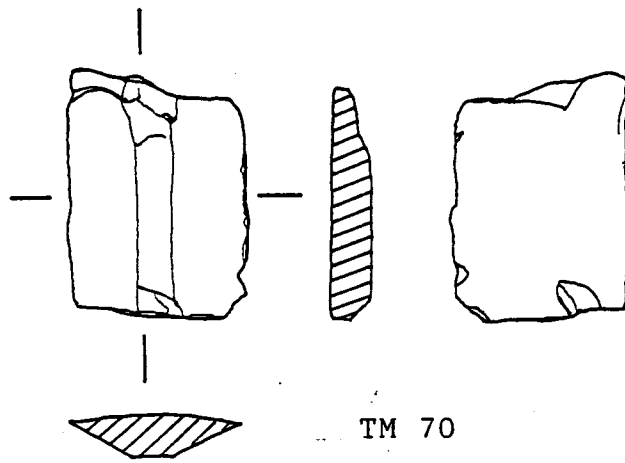

TM 70

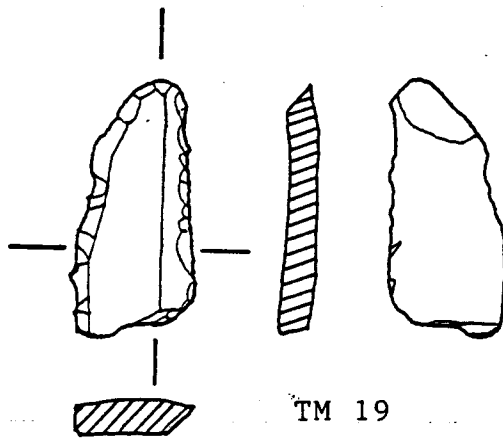

TM 19





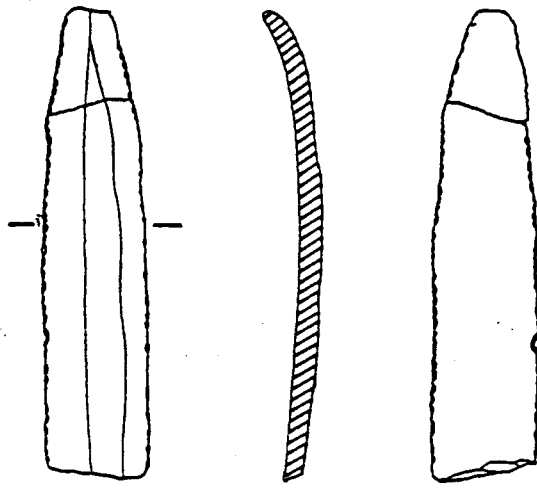

TM 80

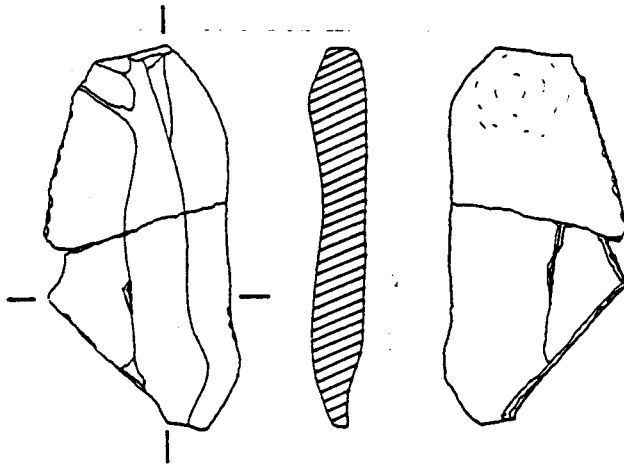

TM 87

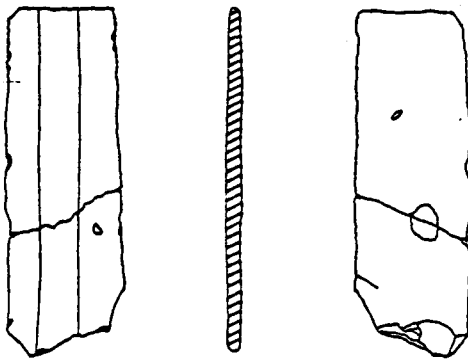

TM 77

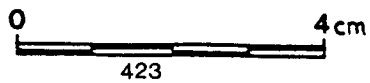

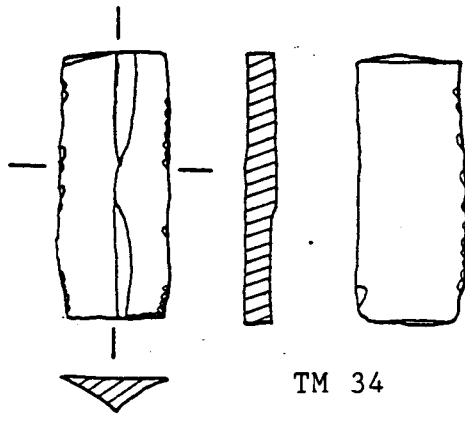

TM 34

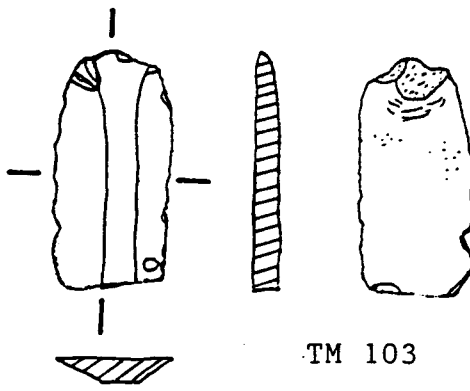

TM 103

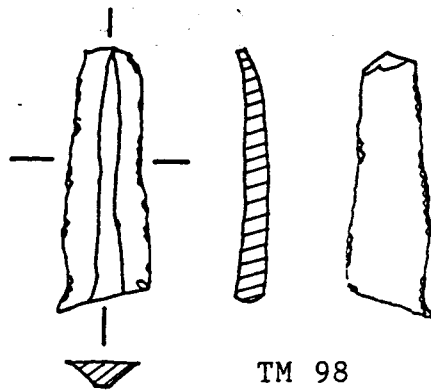

TM 98



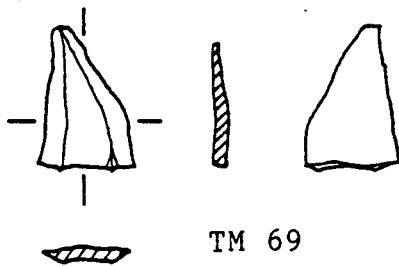

TM 69

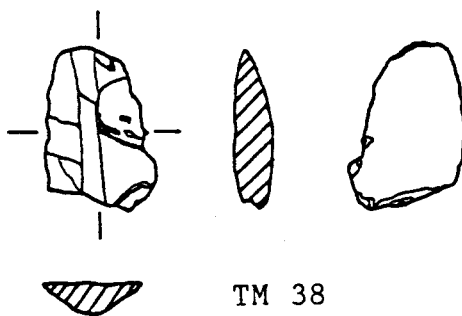

TM 38

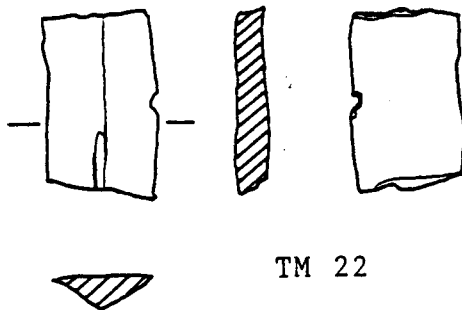

TM 22

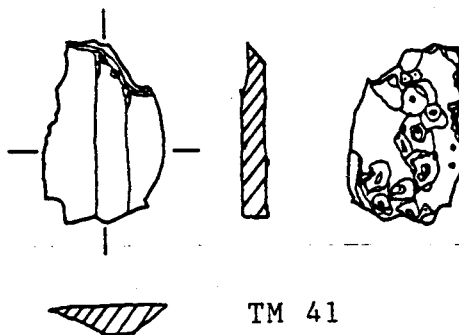

TM 41

0 3cm

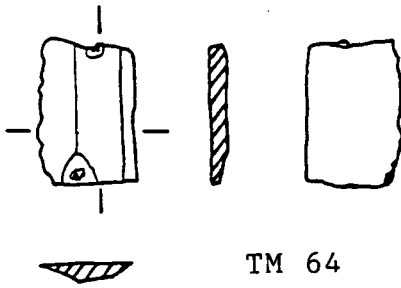

TM 64

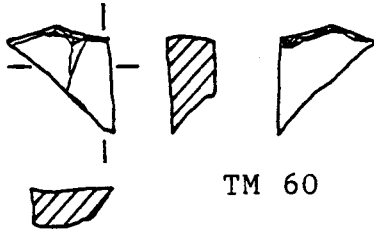

TM 60

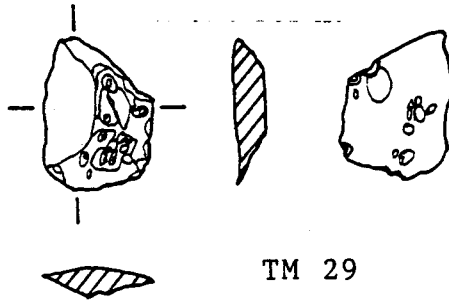

TM 29

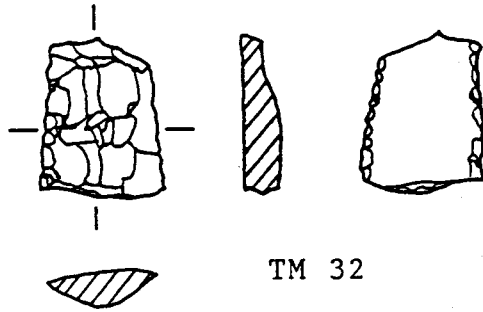

TM 32

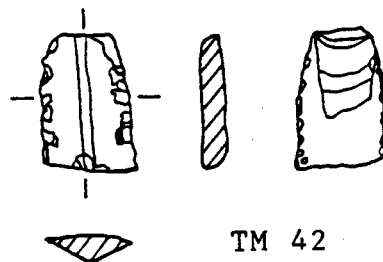

TM 42



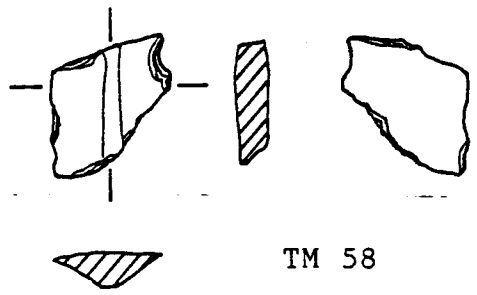
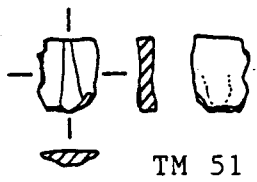
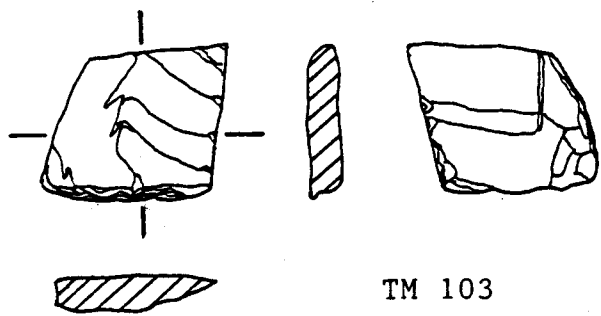
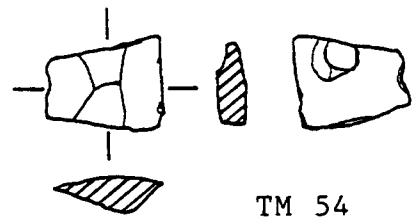
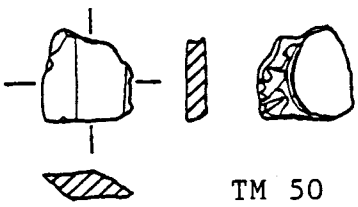
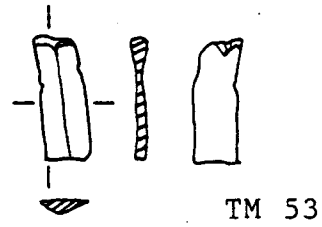
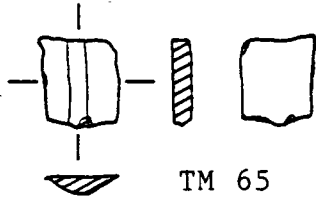
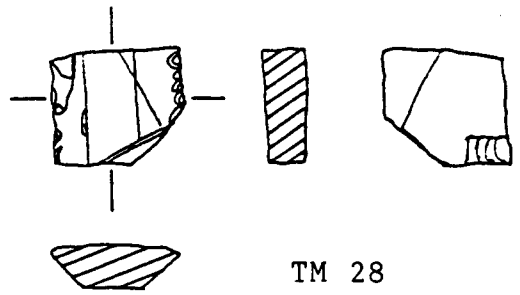
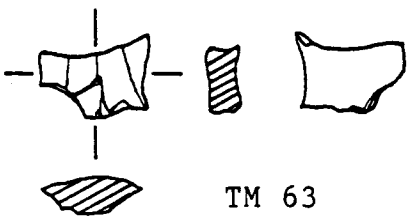

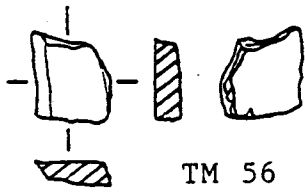

TM 56

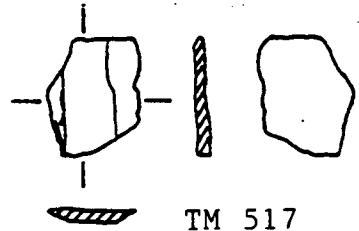

TM 517

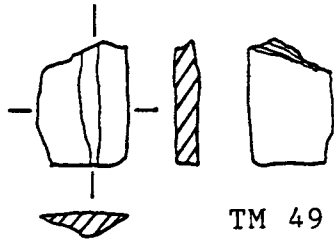

TM 49

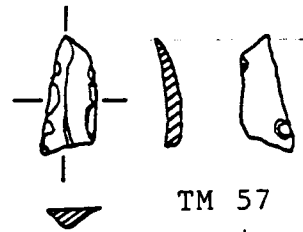

TM 57

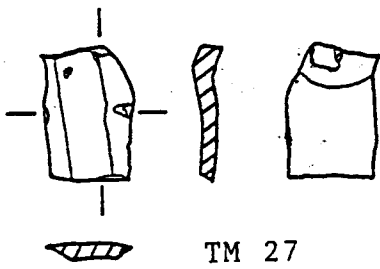

TM 27

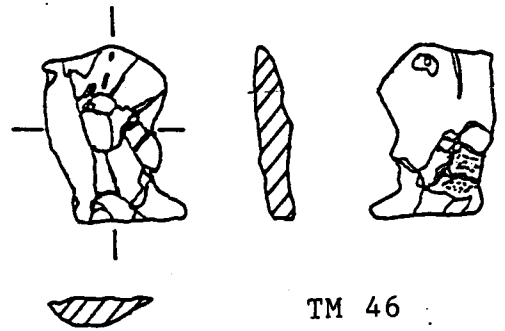

TM 46

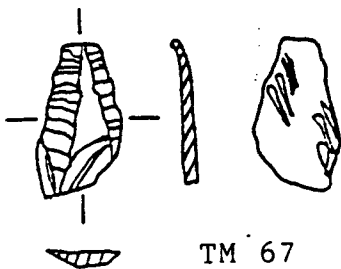

TM 67

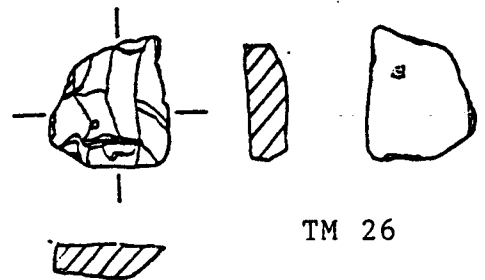

TM 26

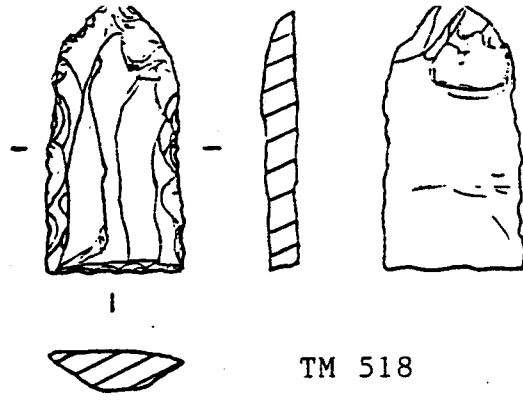

TM 518

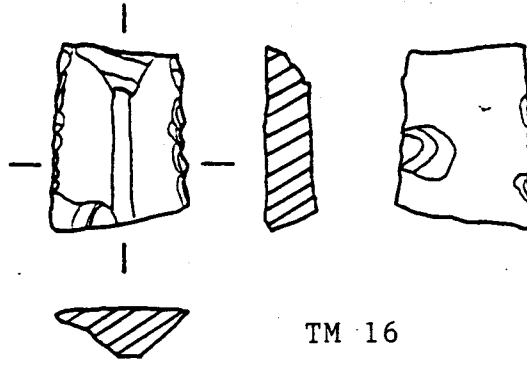

TM 16

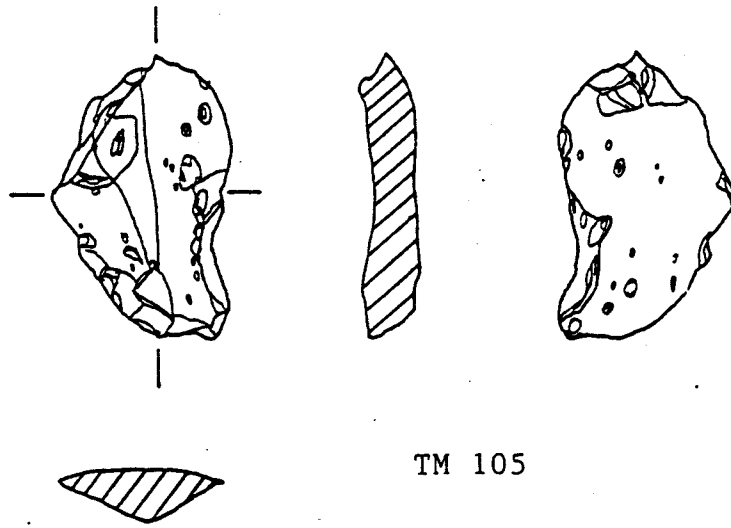

TM 105

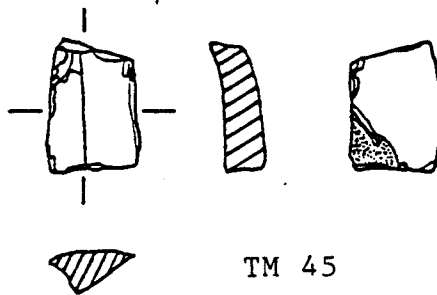

TM 45



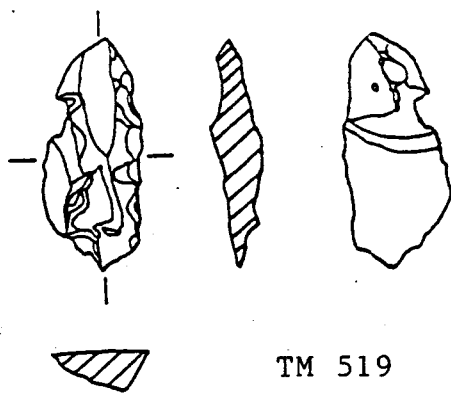

TM 519

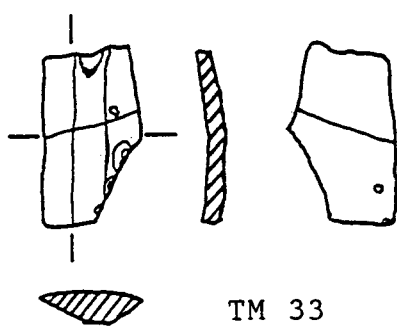

TM 33

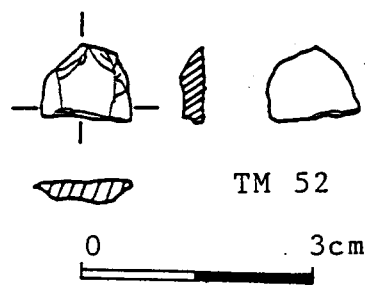

TM 52

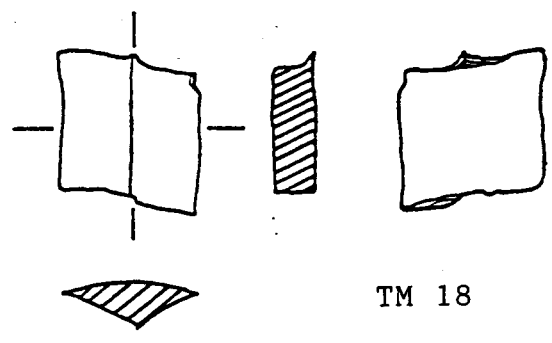

TM 18

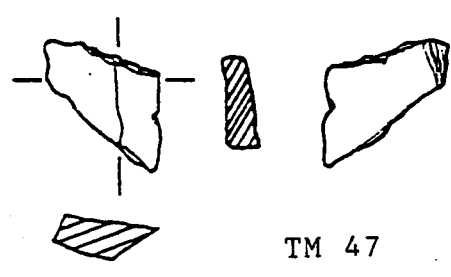

TM 47



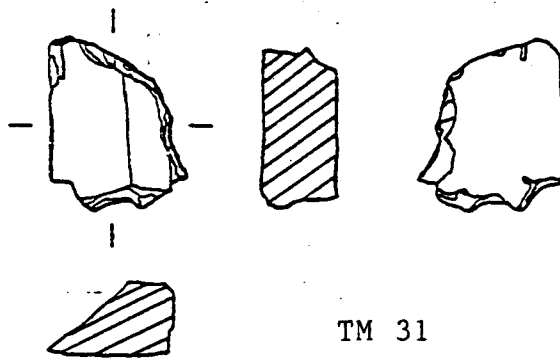

TM 31

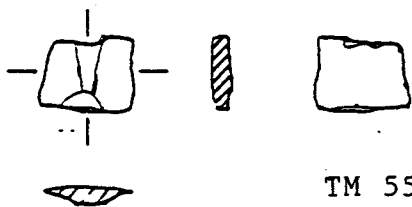

TM 55

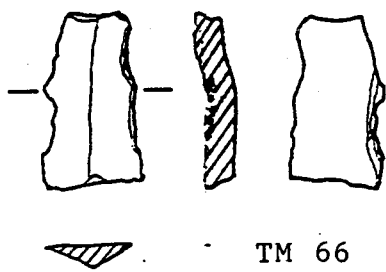

TM 66

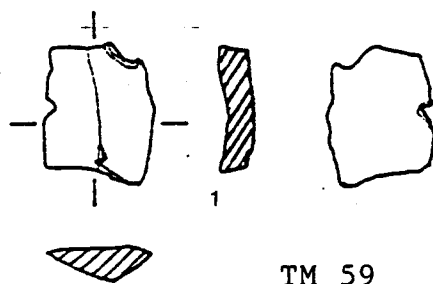

TM 59

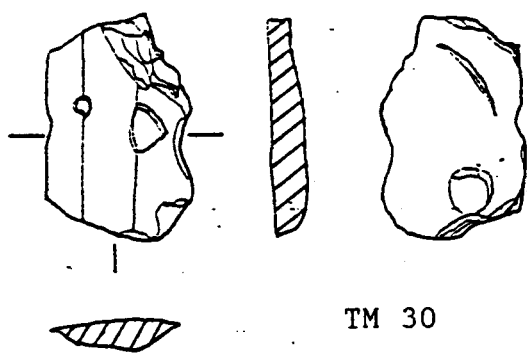

TM 30

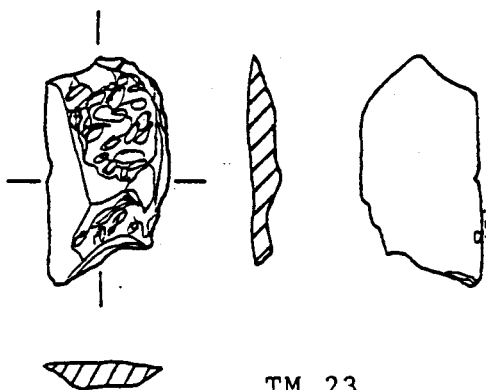

TM 23

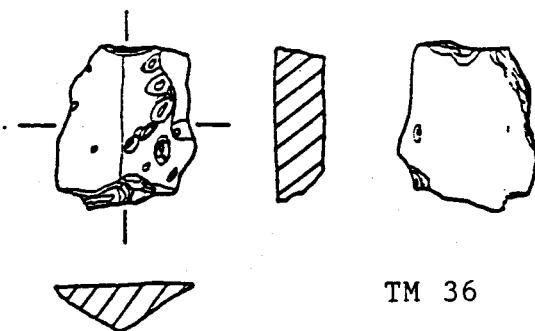

TM 36

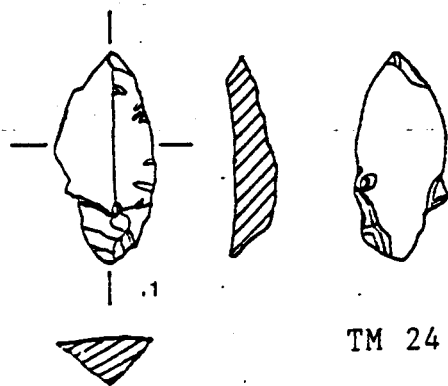

TM 24

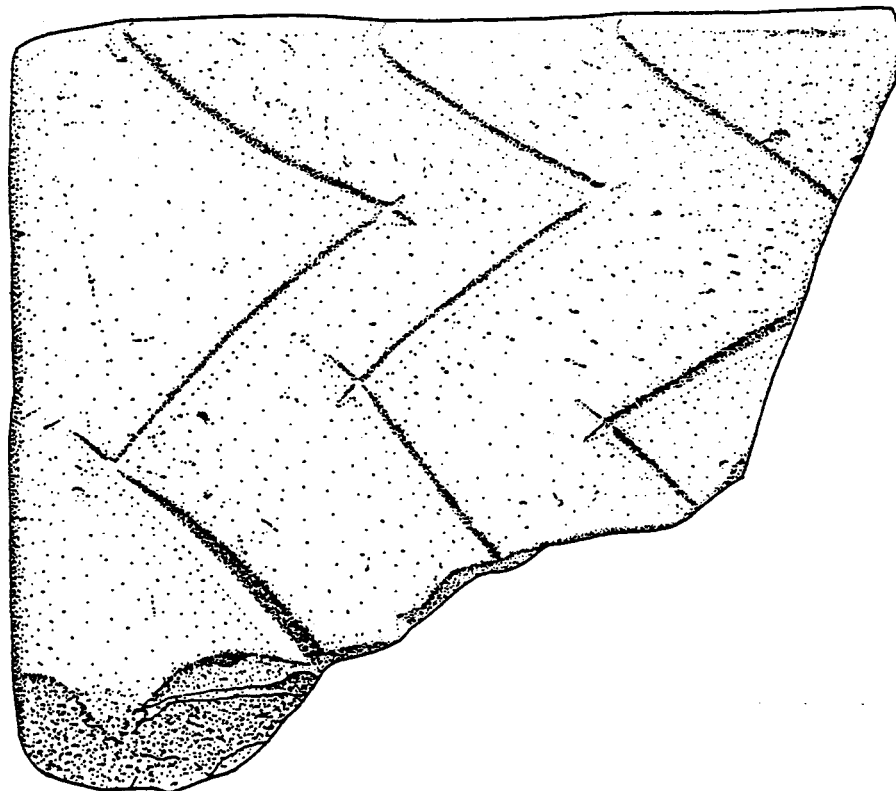
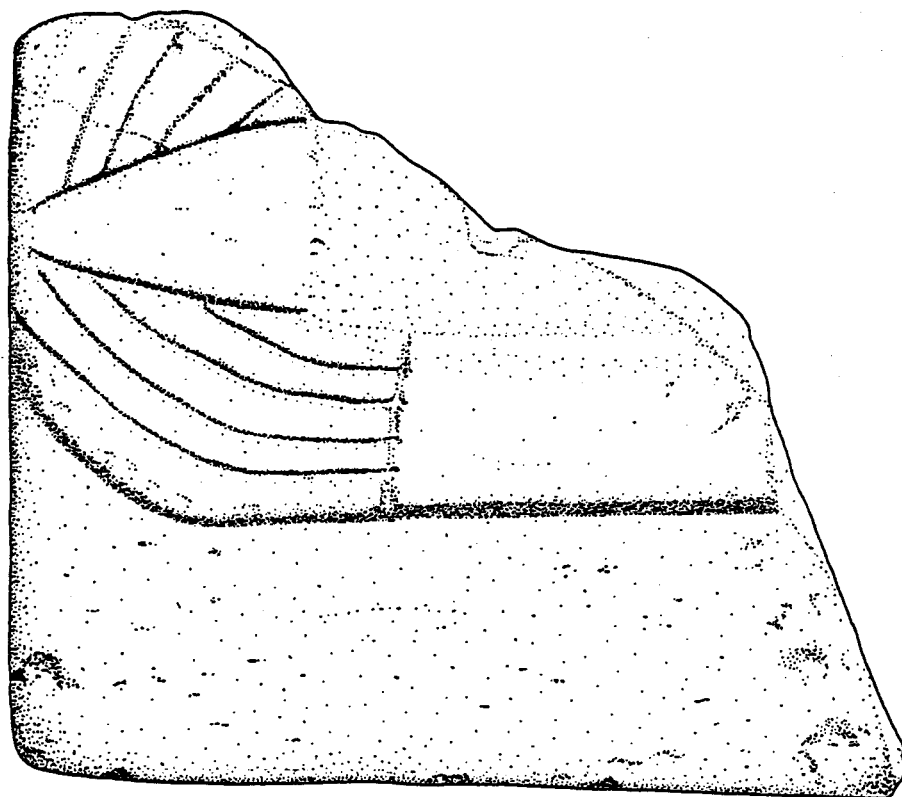

TM 282



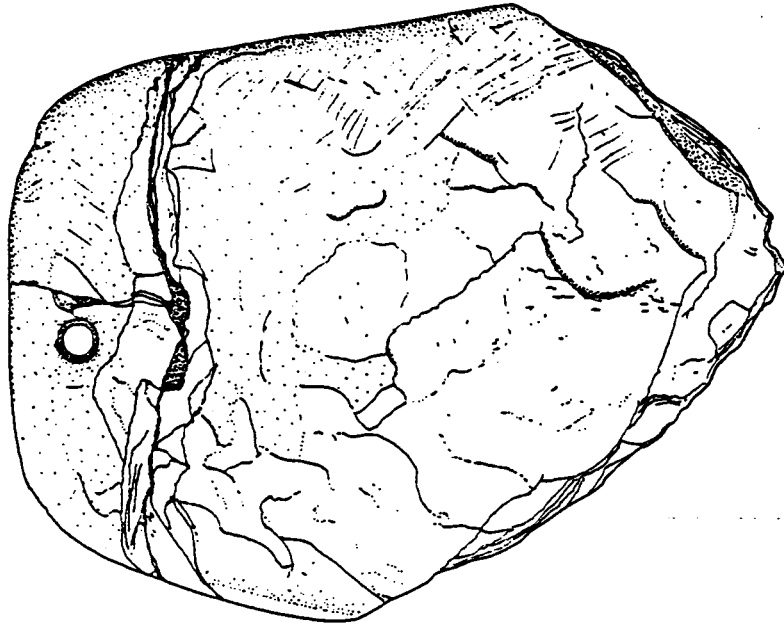

TM 274

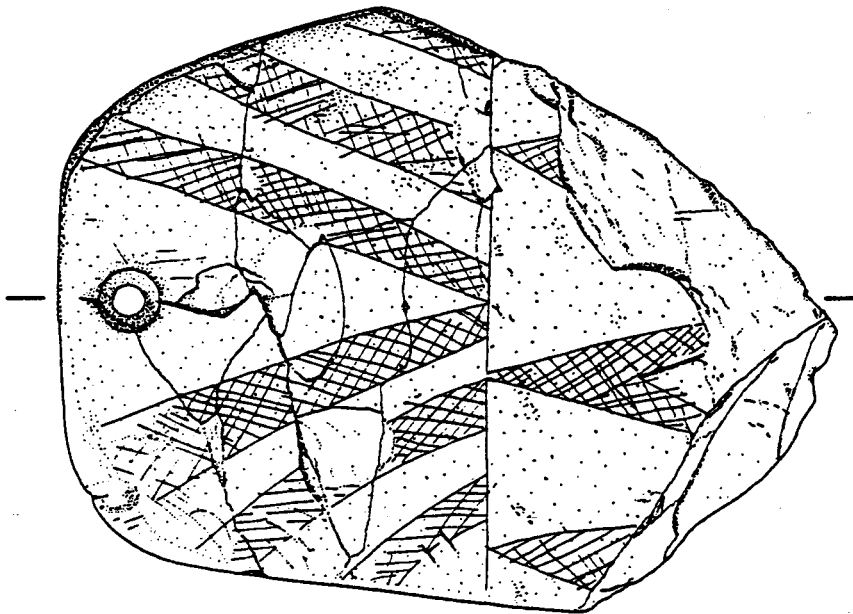

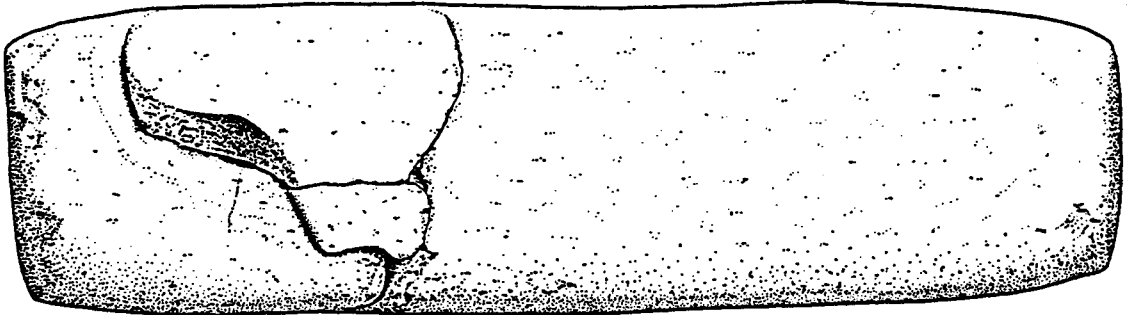
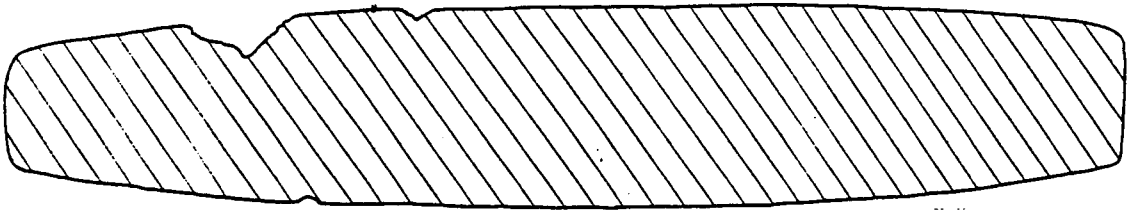
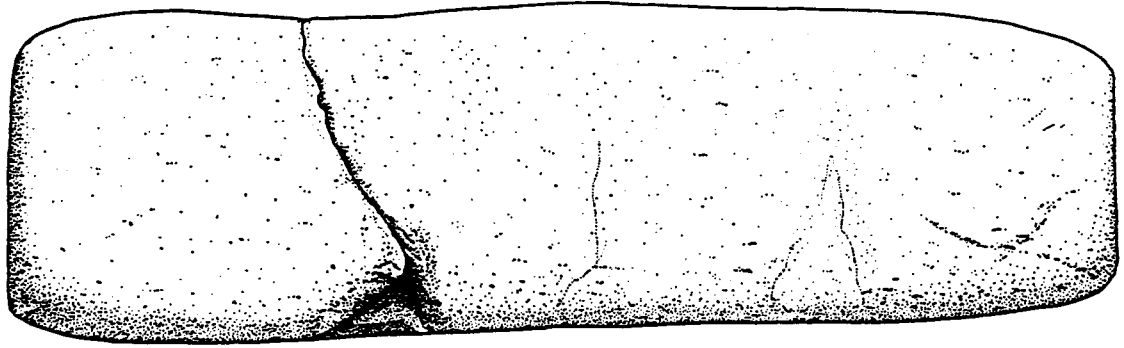

TM 281

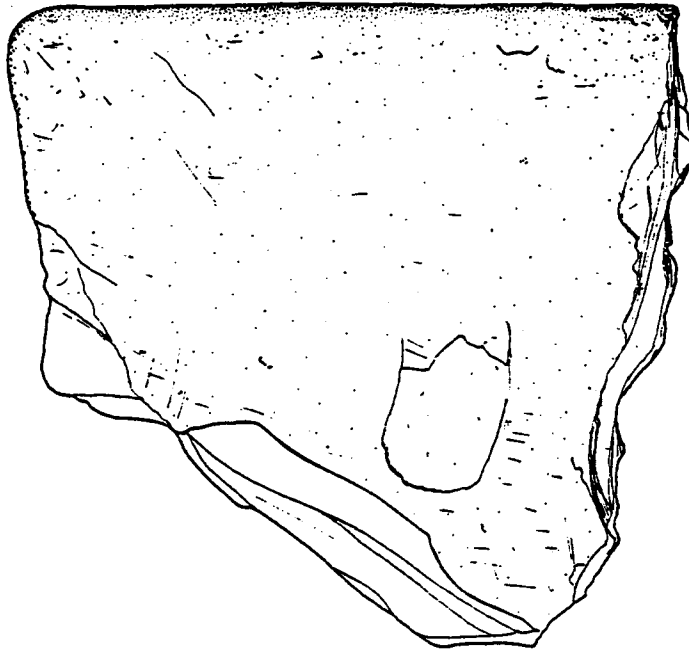

TM 277

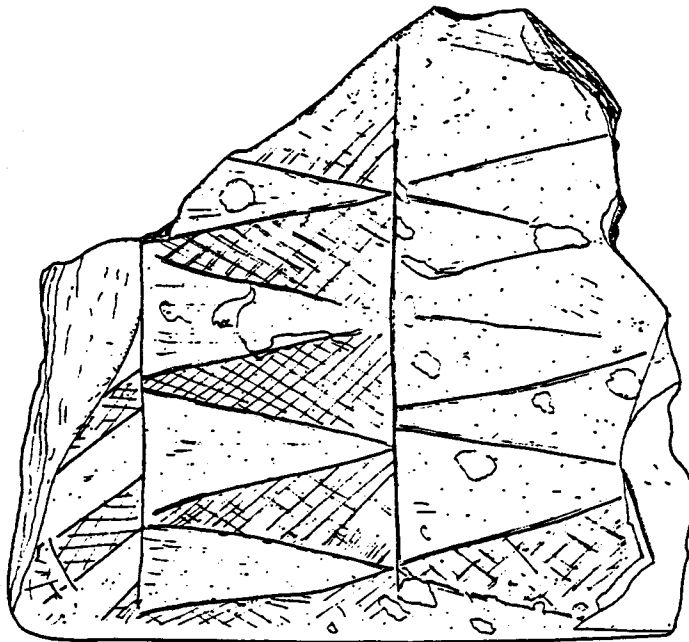

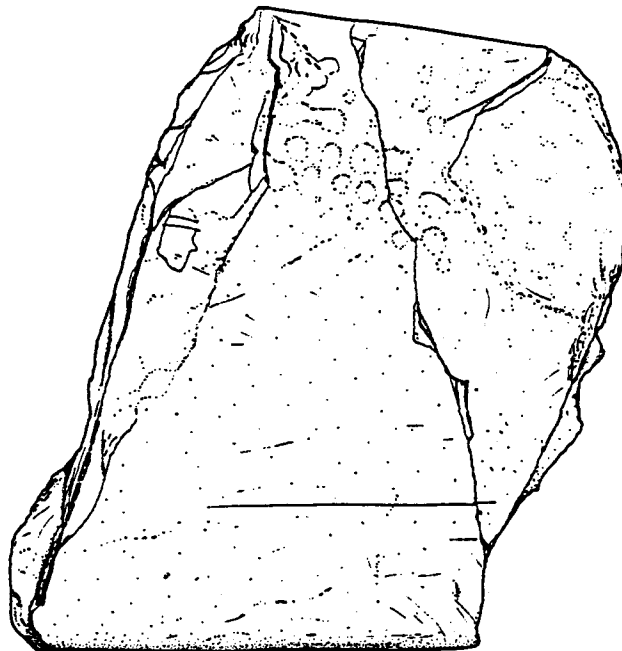
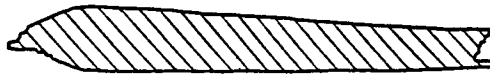
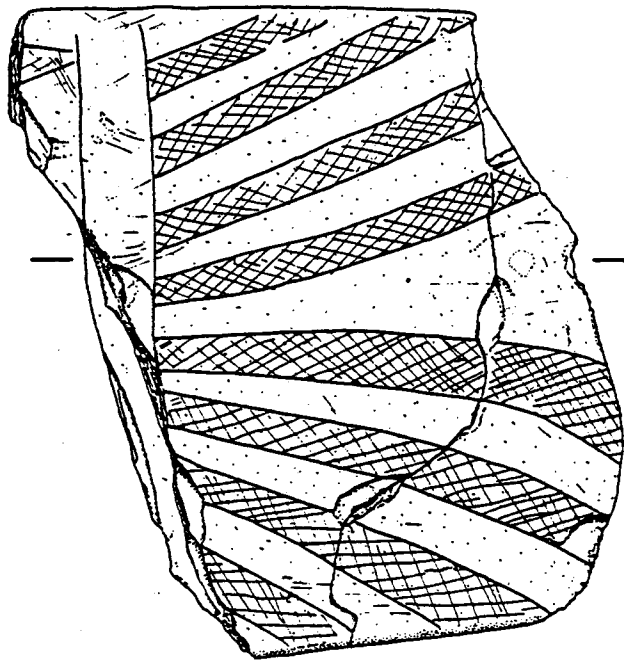

TM 279

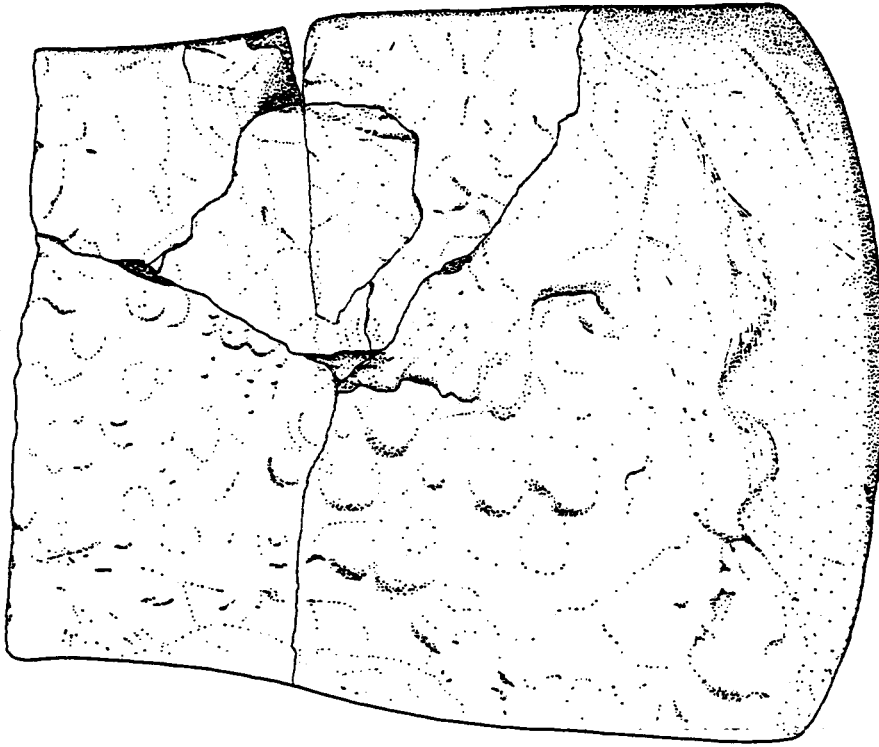

TM 273

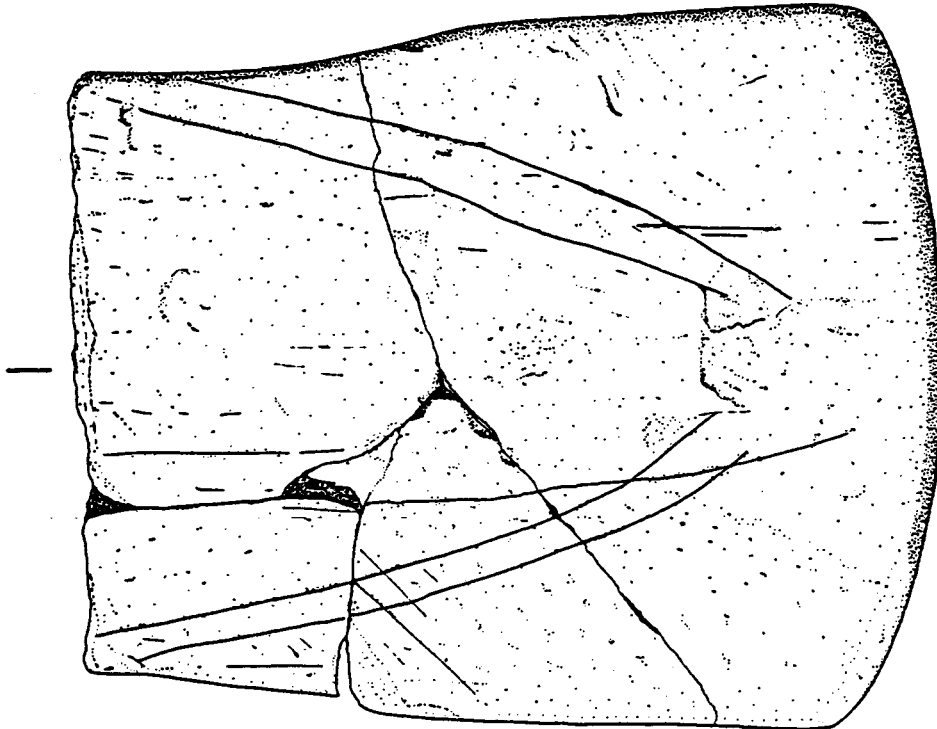



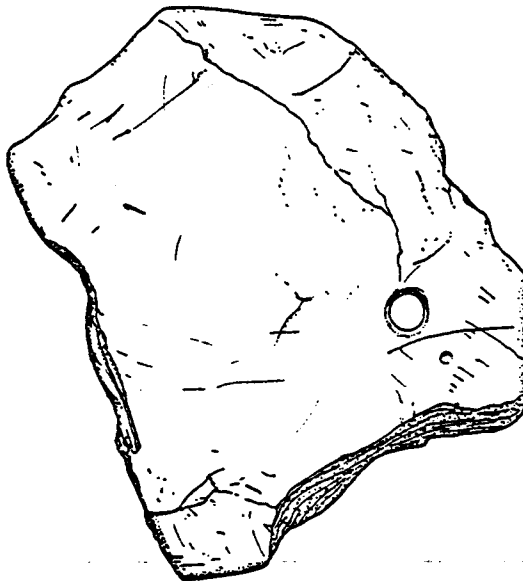
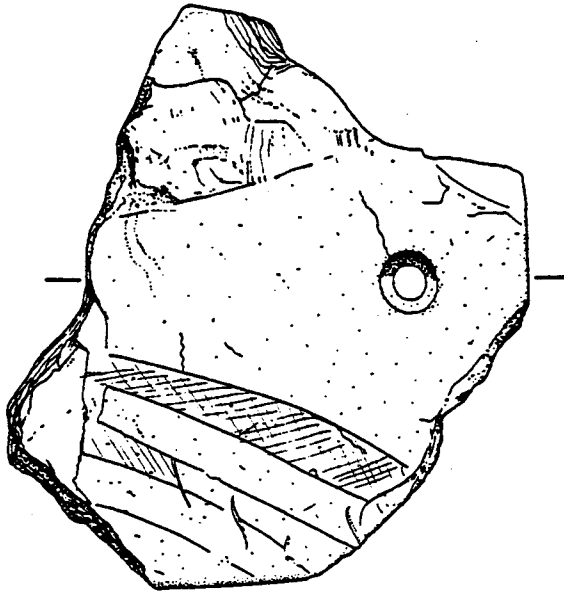

TM 278

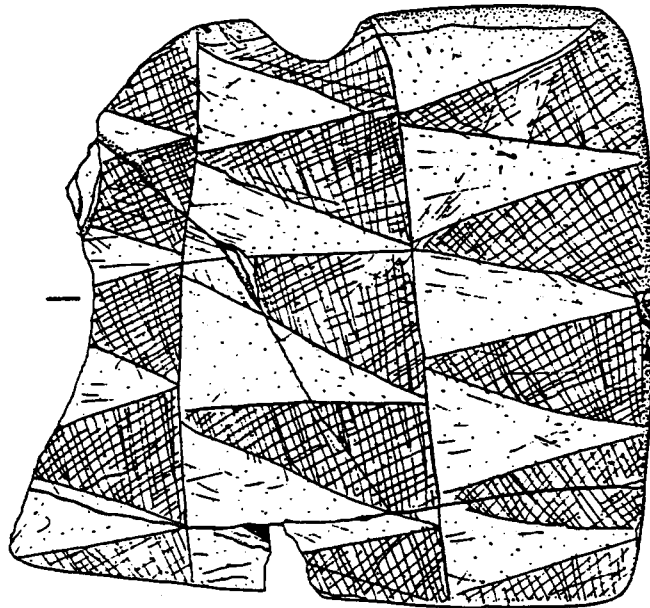
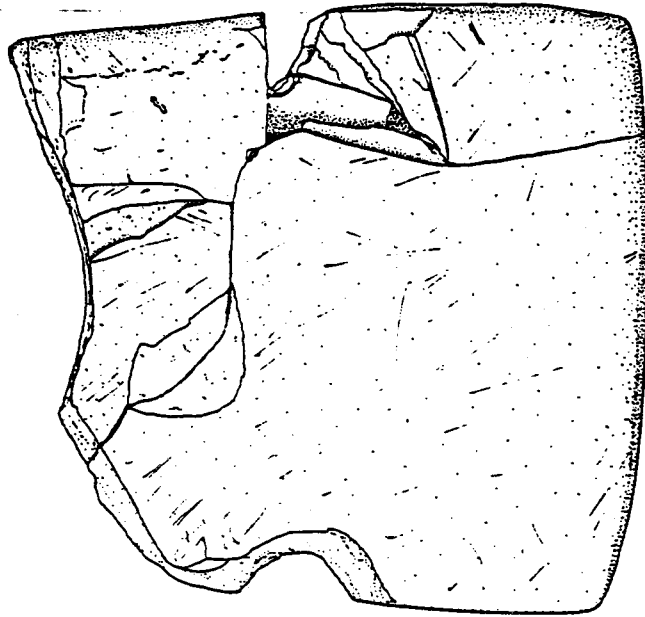

TM 276



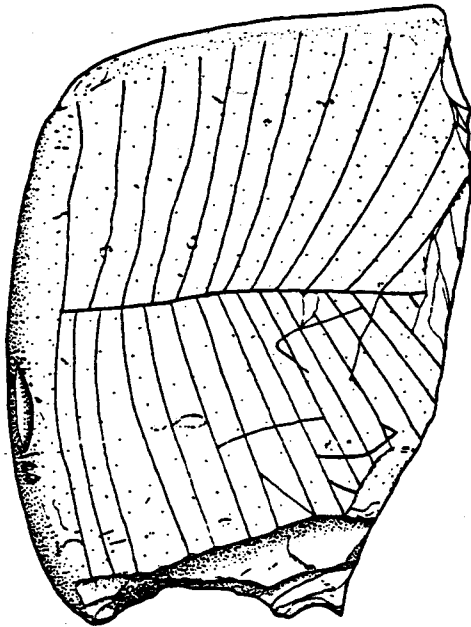
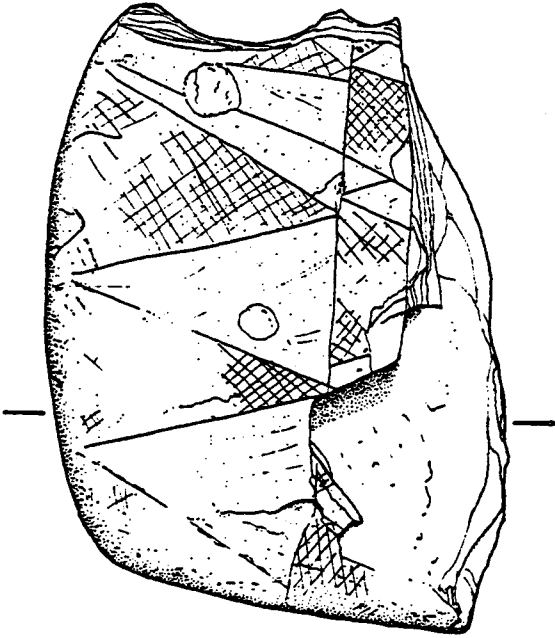

TM 280

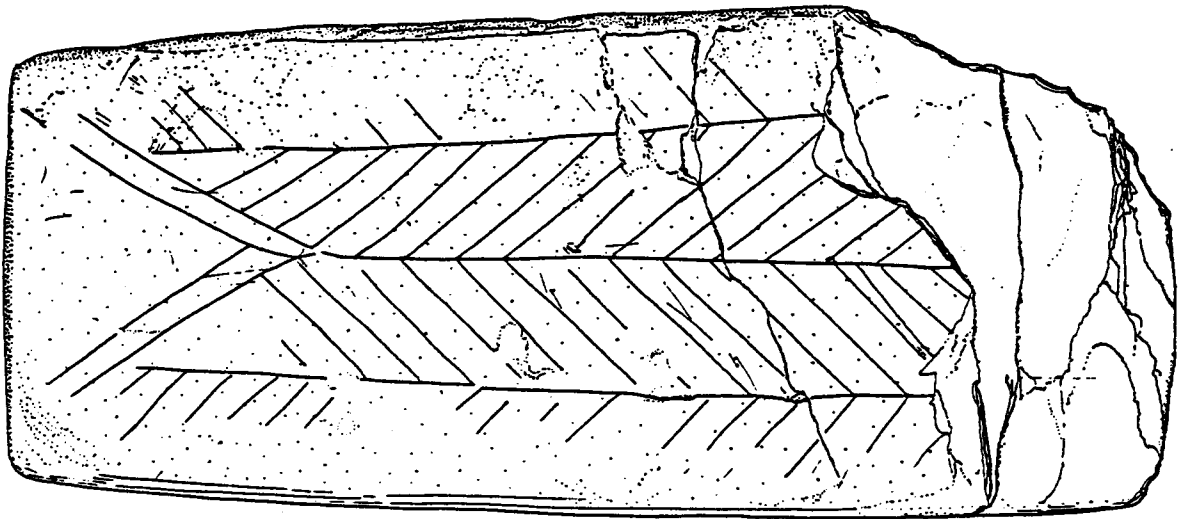
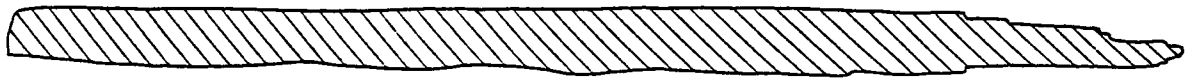

TM 275

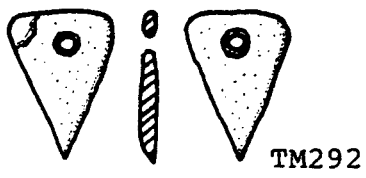

TM292

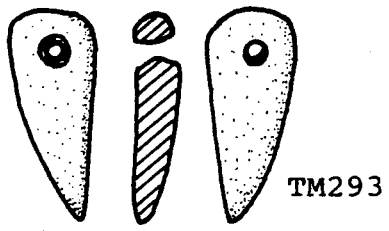

TM293

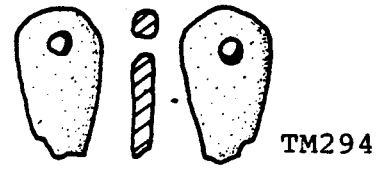

TM294



TM295



TM296

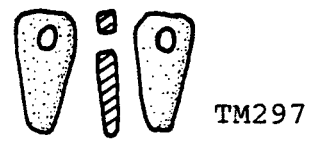

TM297

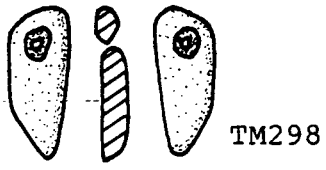

TM298



TM302



TM303



TM304

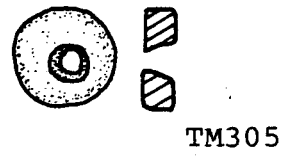

TM305

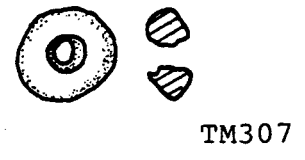

TM307



TM464

TM 465-489



308-463



490-499

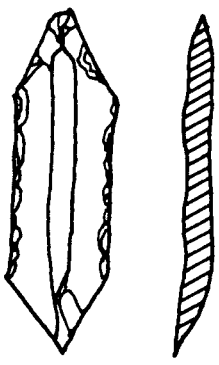

TM500

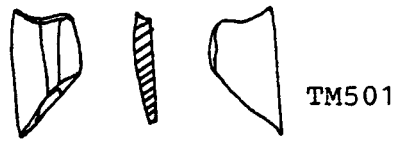

TM501

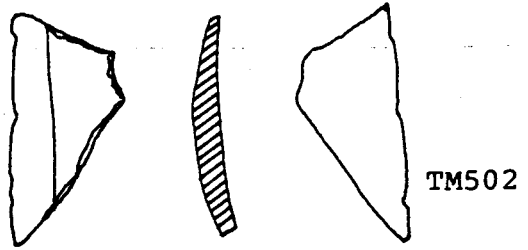

TM502



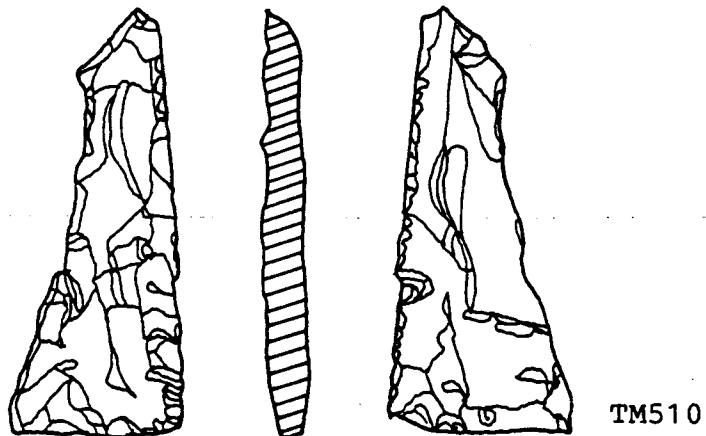
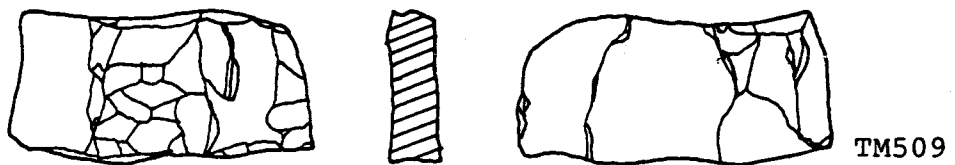
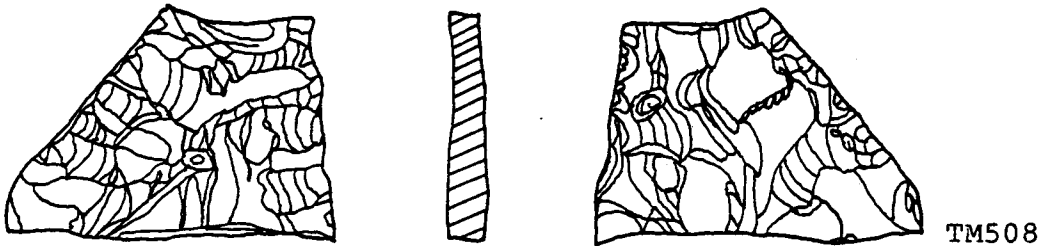
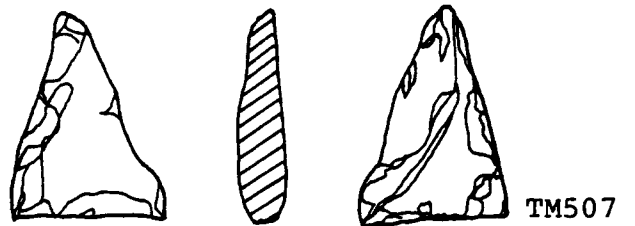
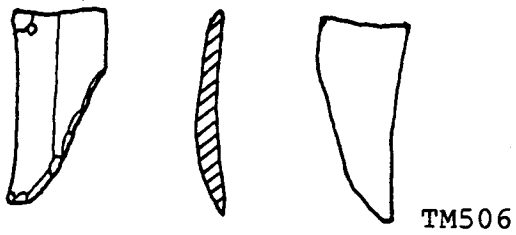
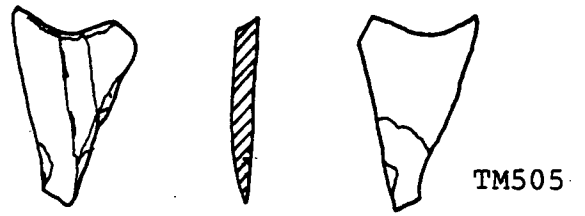
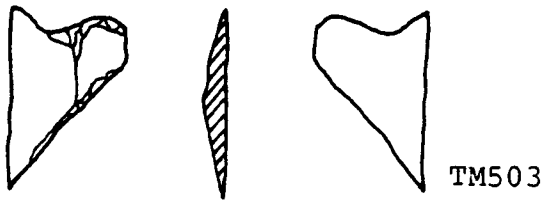



**ANTA**  
**do**  
**TAPADÃO DA RELVA**





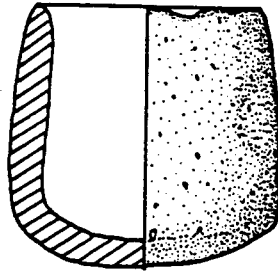

TR 11

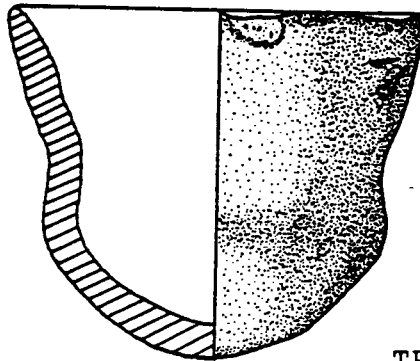

TR 22

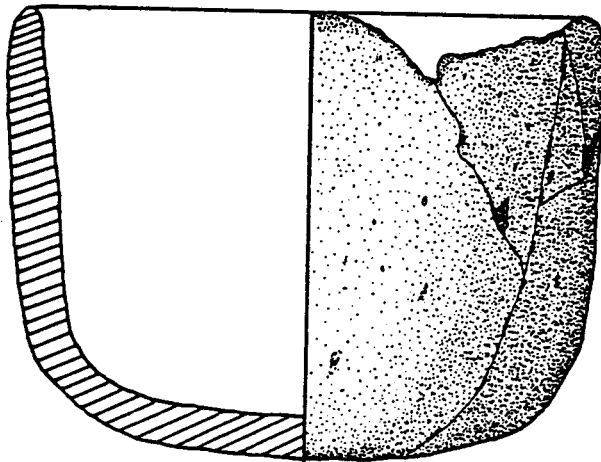

TR 15



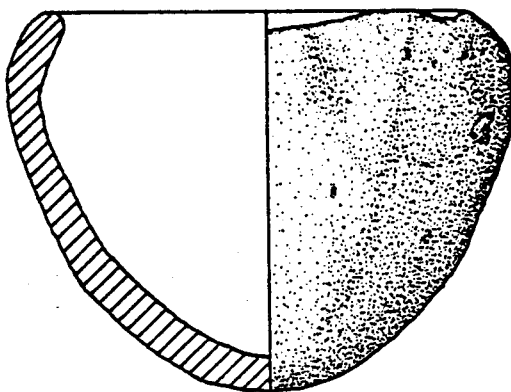

TR 14

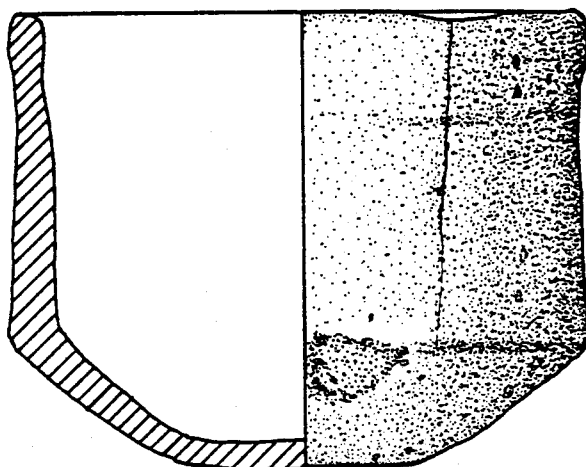

TR 1

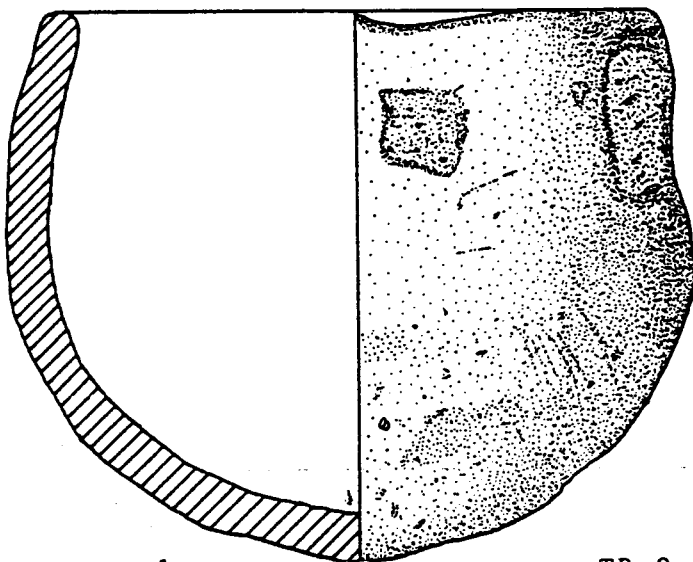

TR 2



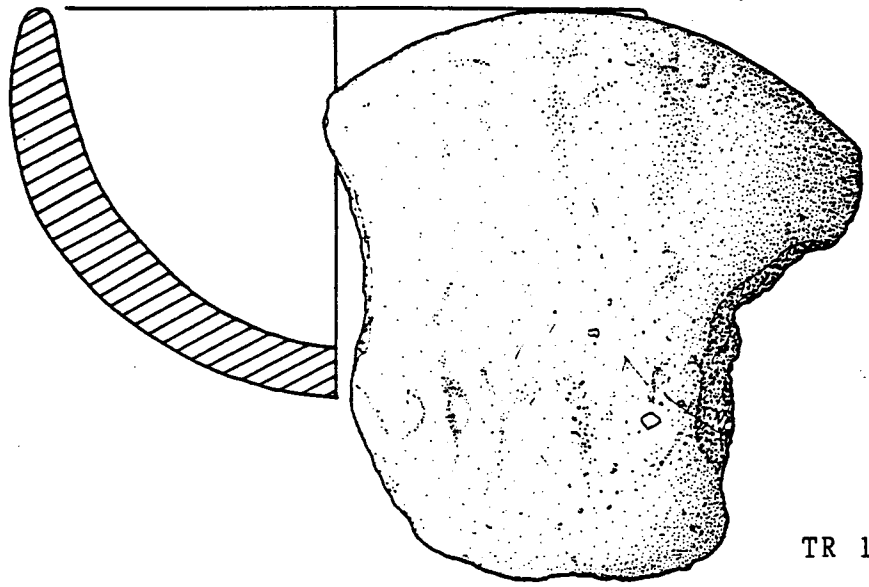

TR 19

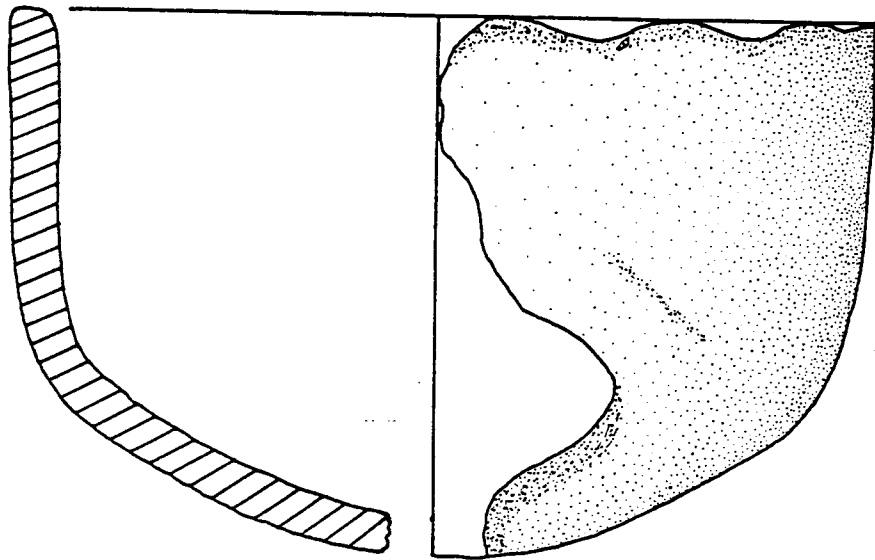

TR 6

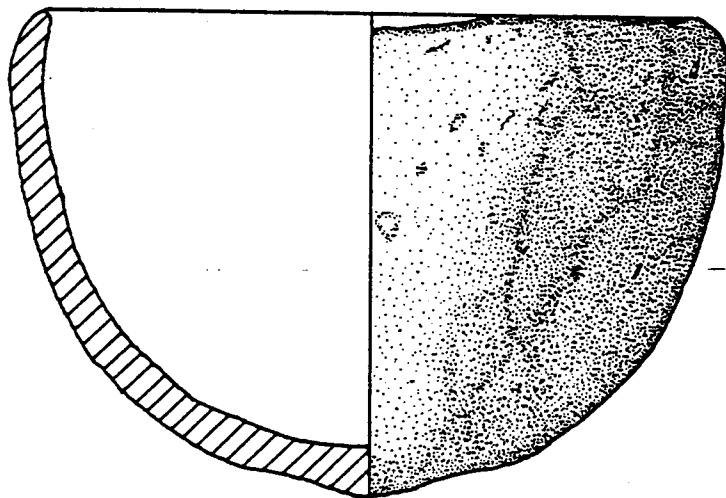

TR 16

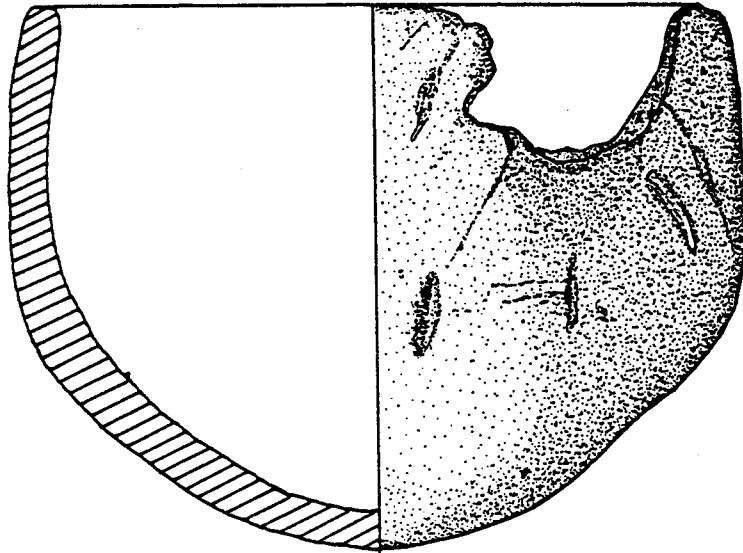

TR 10

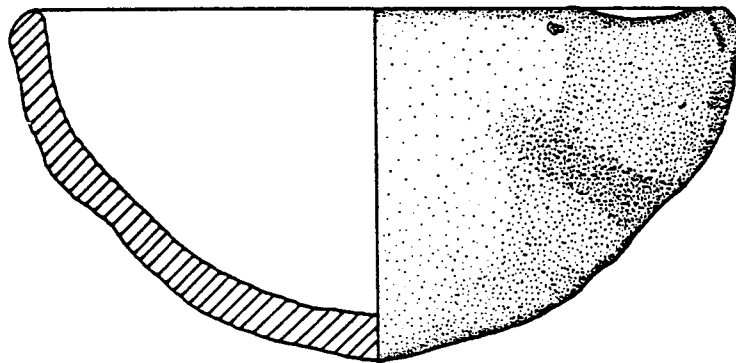

TR 8



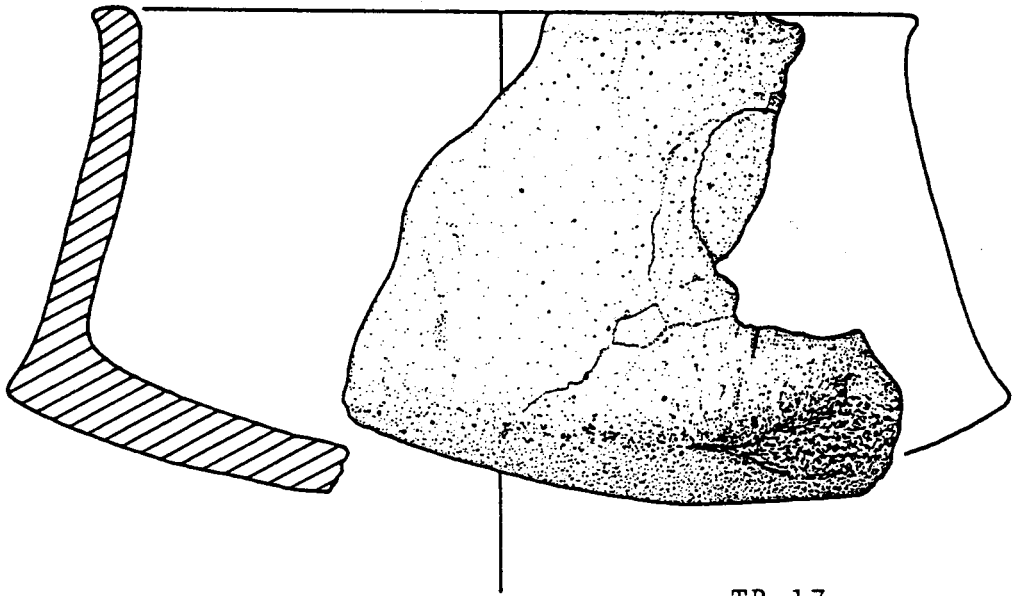

TR 17

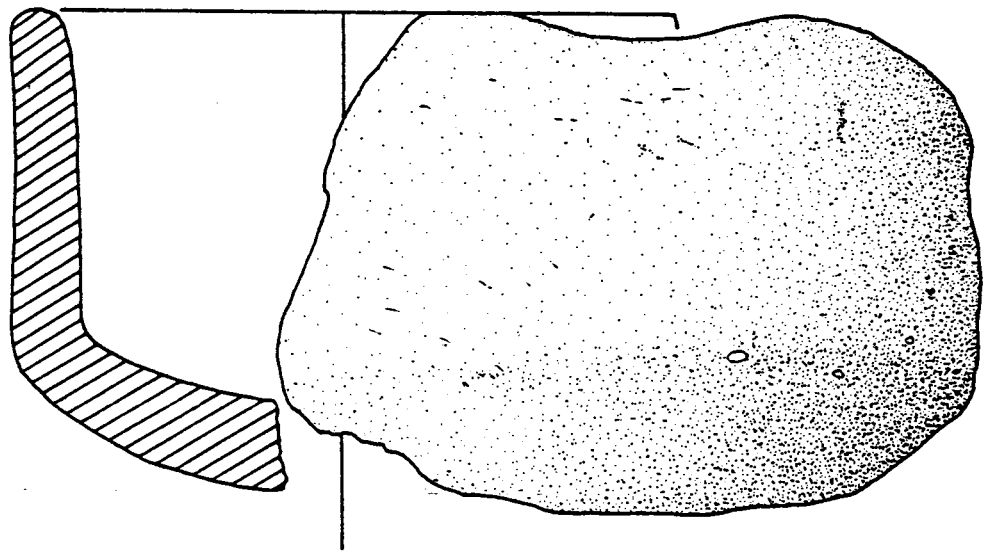

TR 197



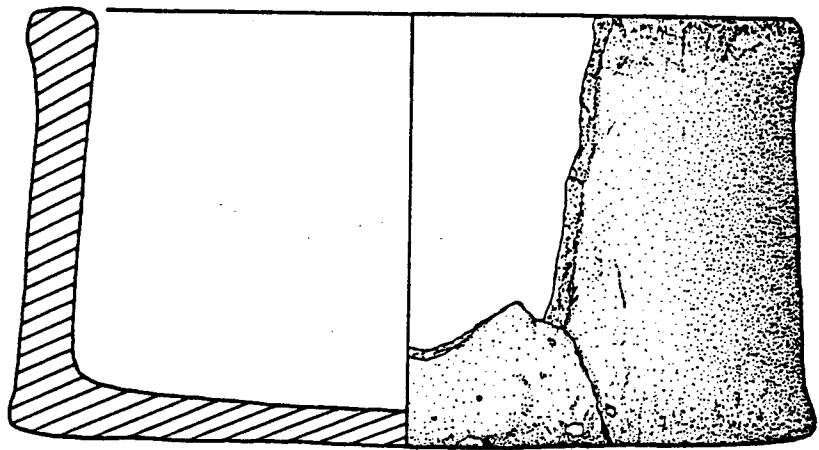

TR 12

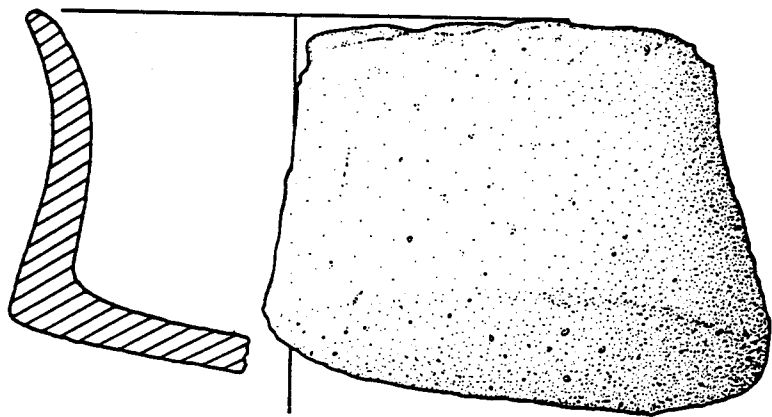

TR 18



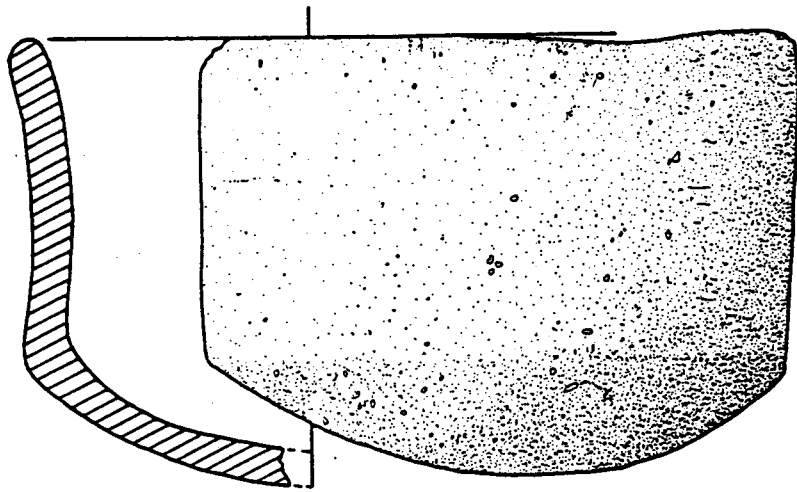

TR 9

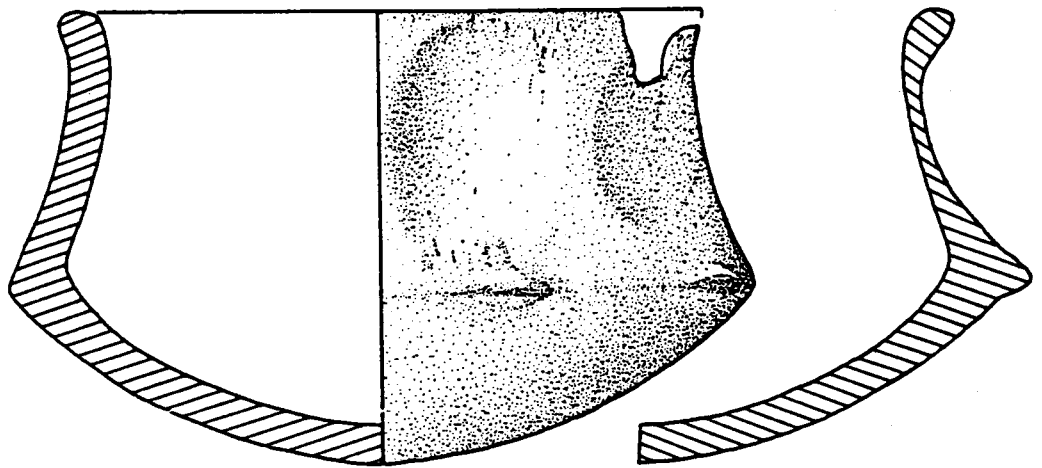

TR 4





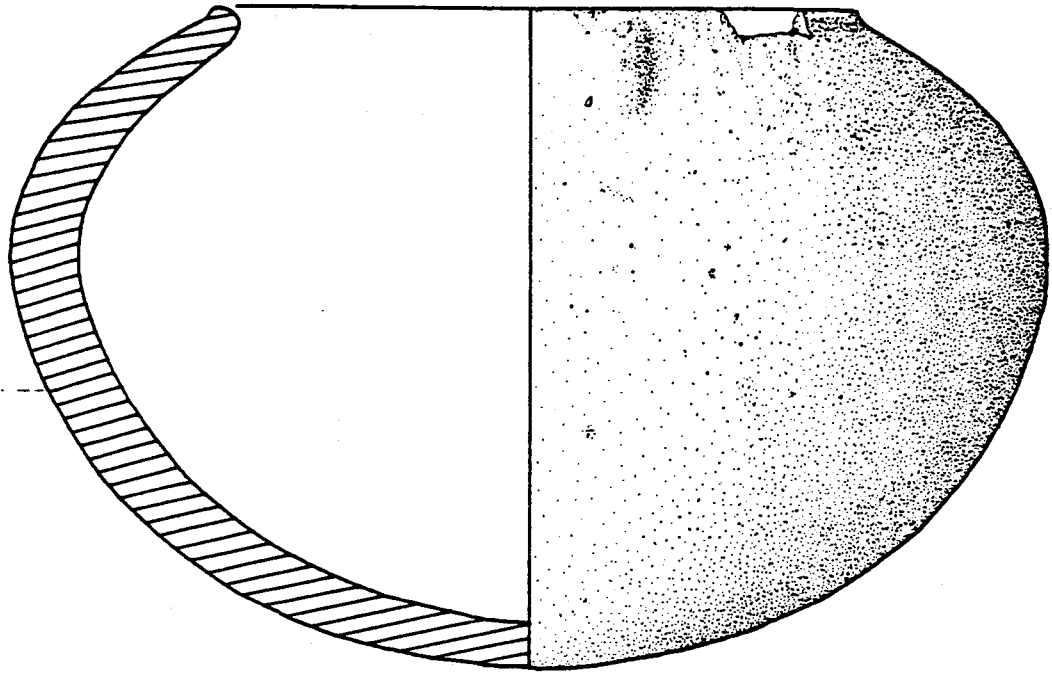

TR 13

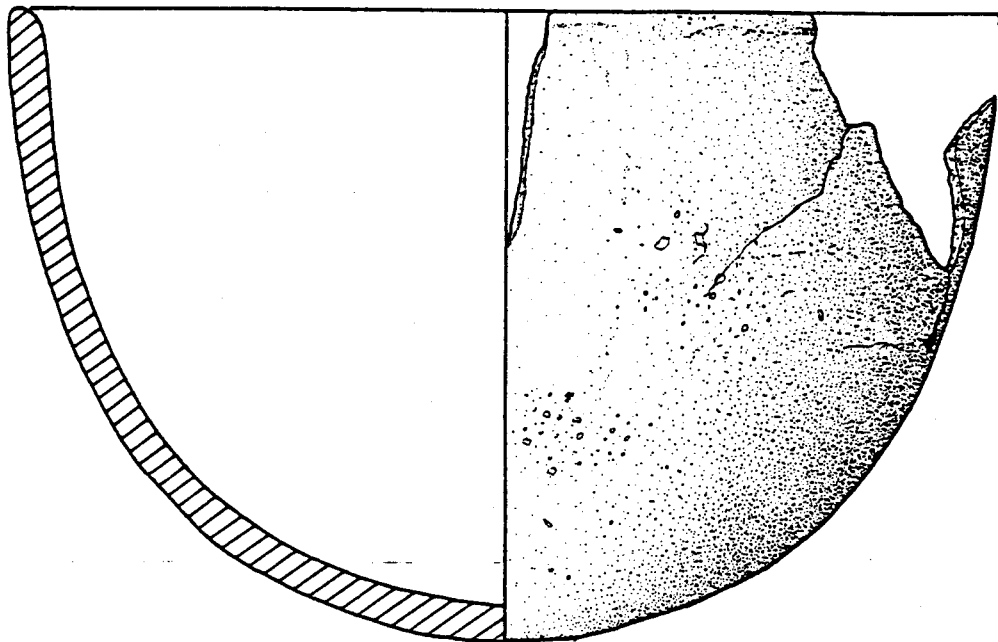

TR 20

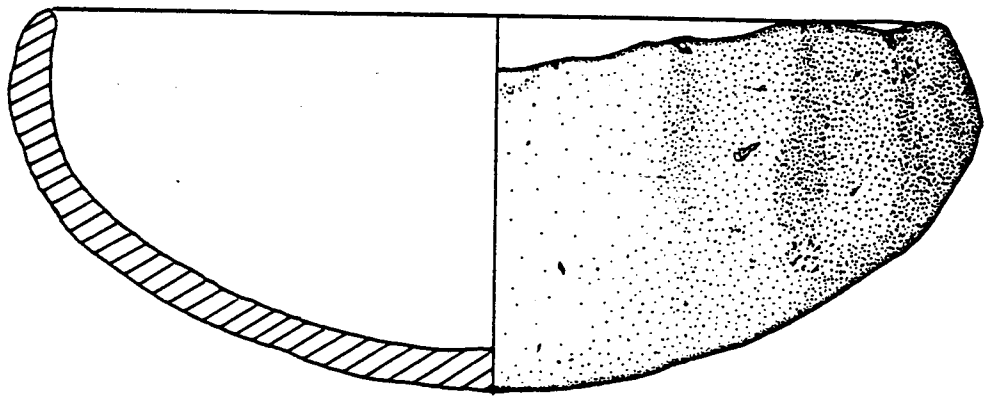

TR 23

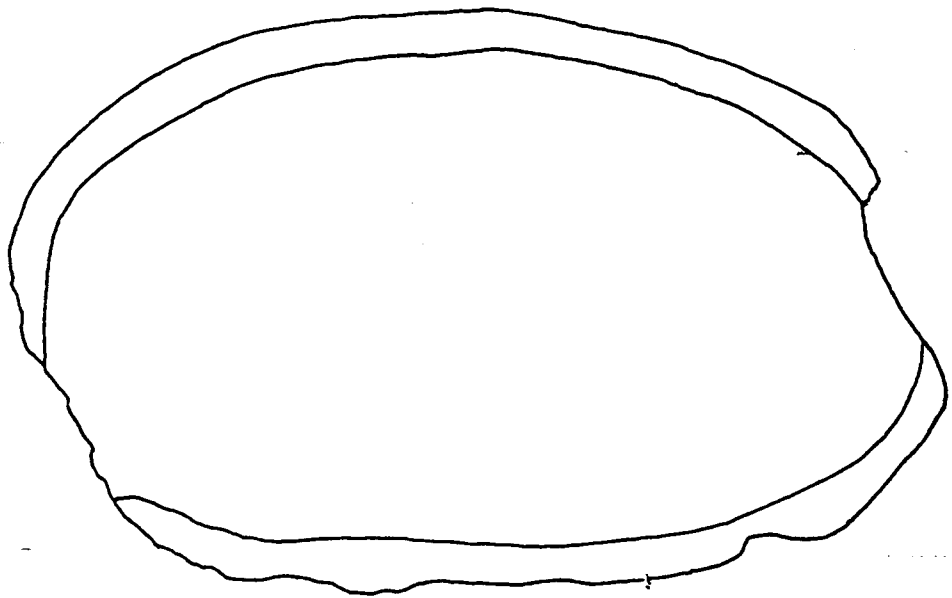

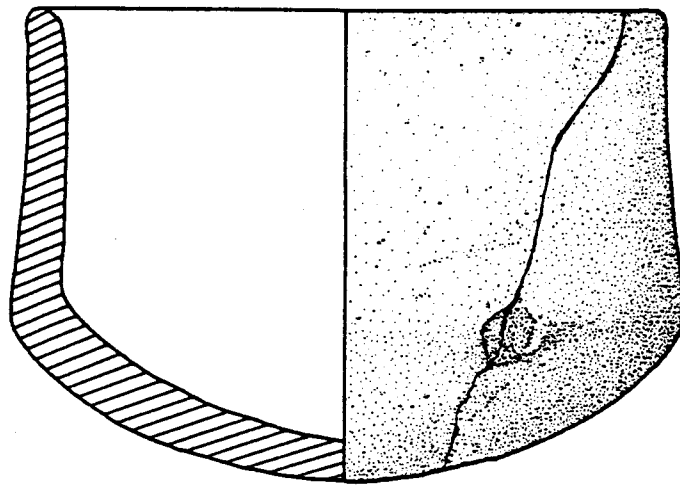

TR 3

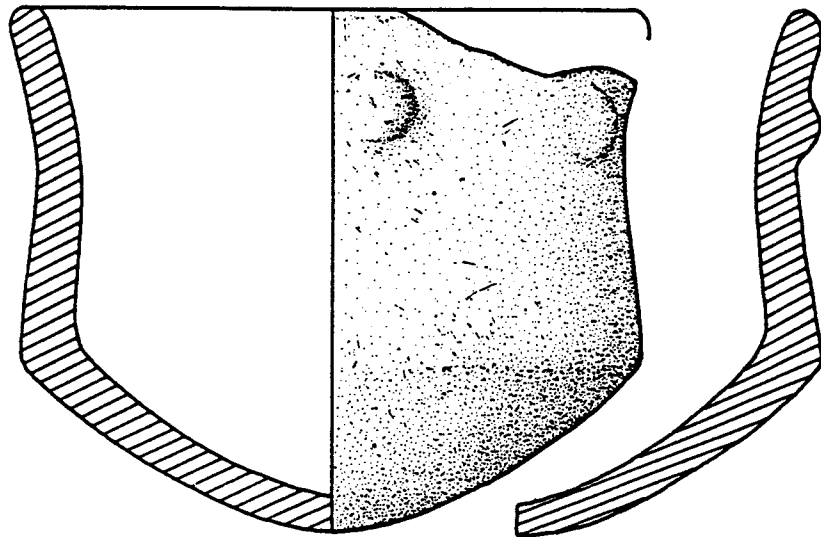

TR 7



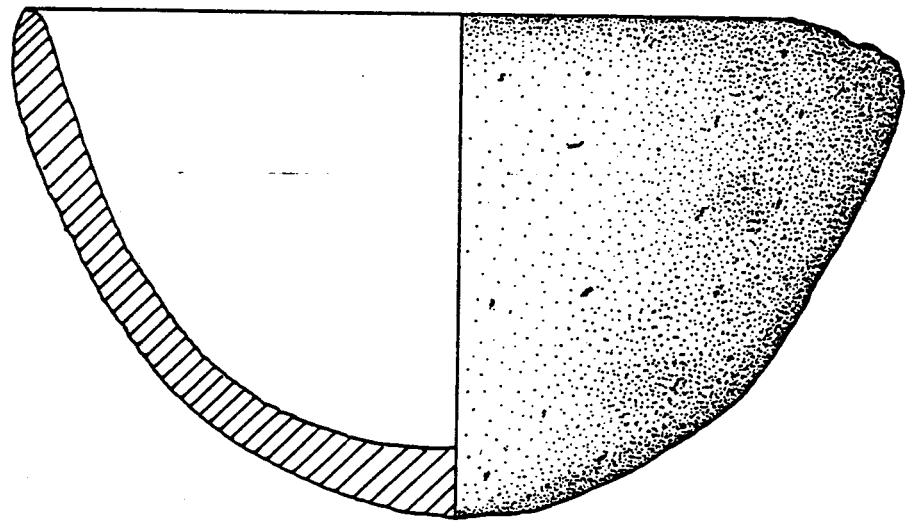

TR 5

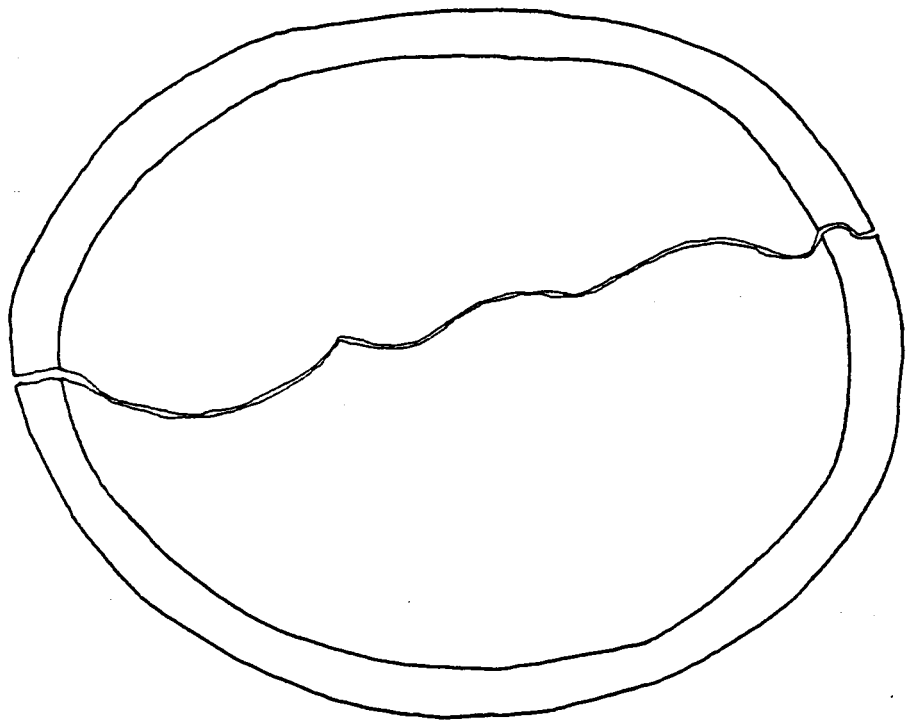

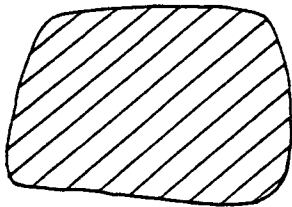
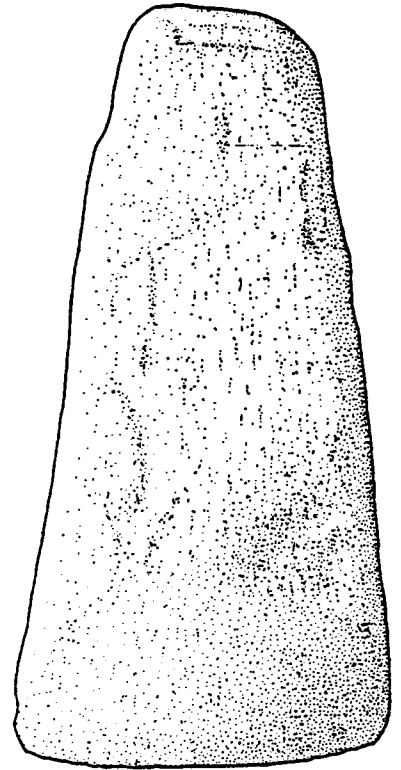
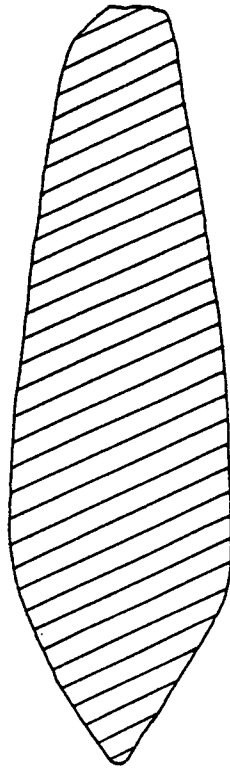
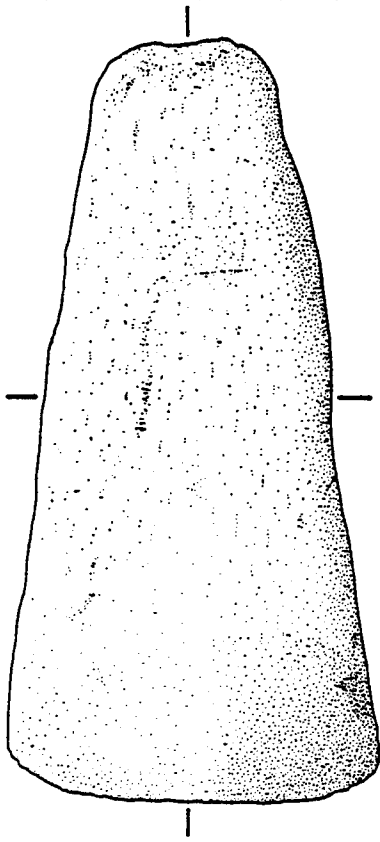

TR 37



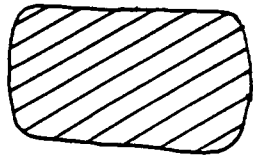
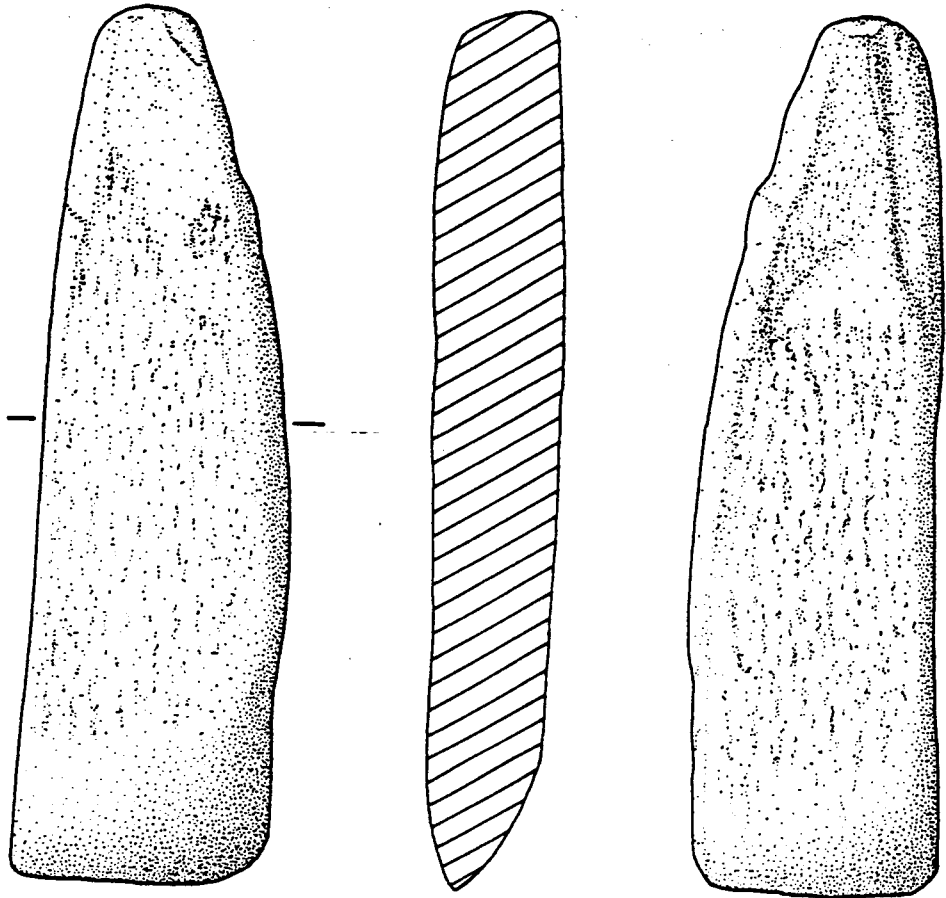

TR 38



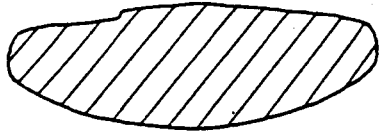
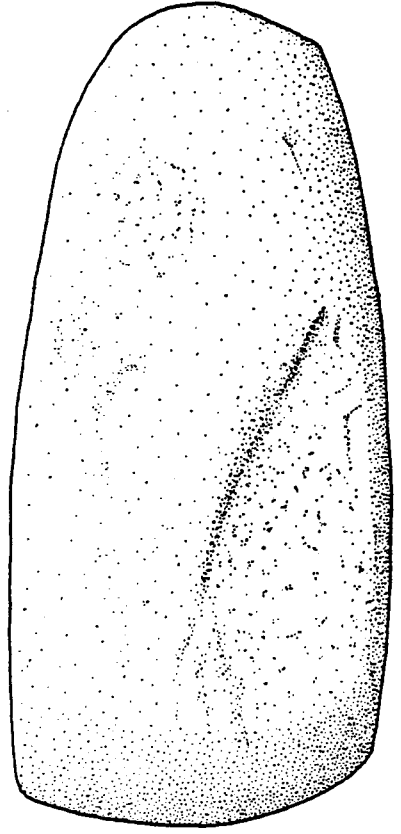
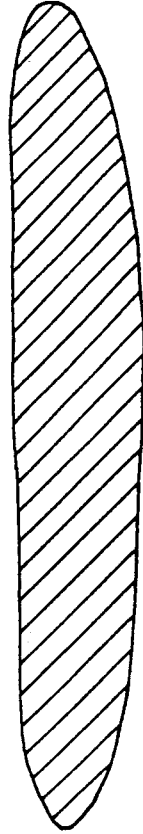
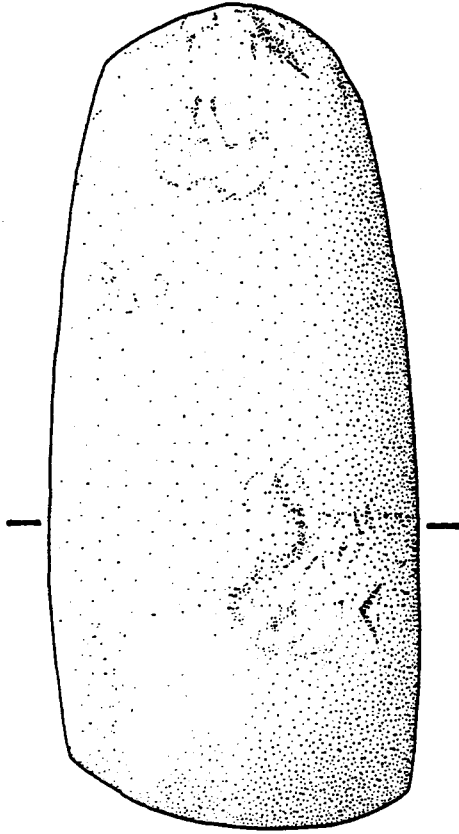

TR 39



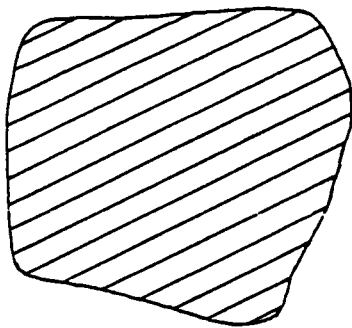
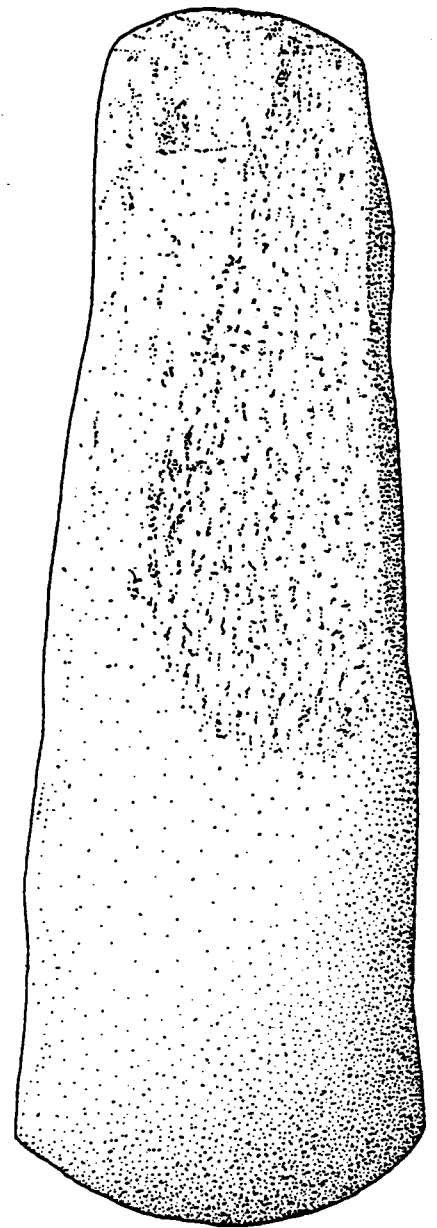
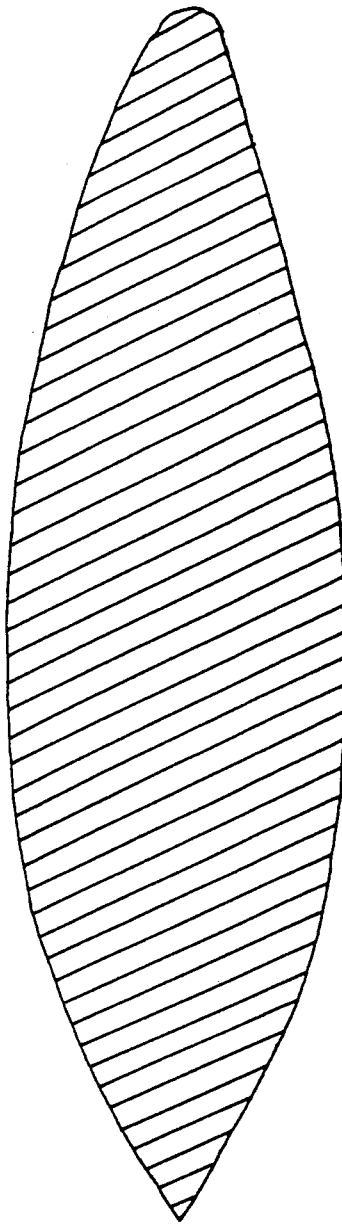
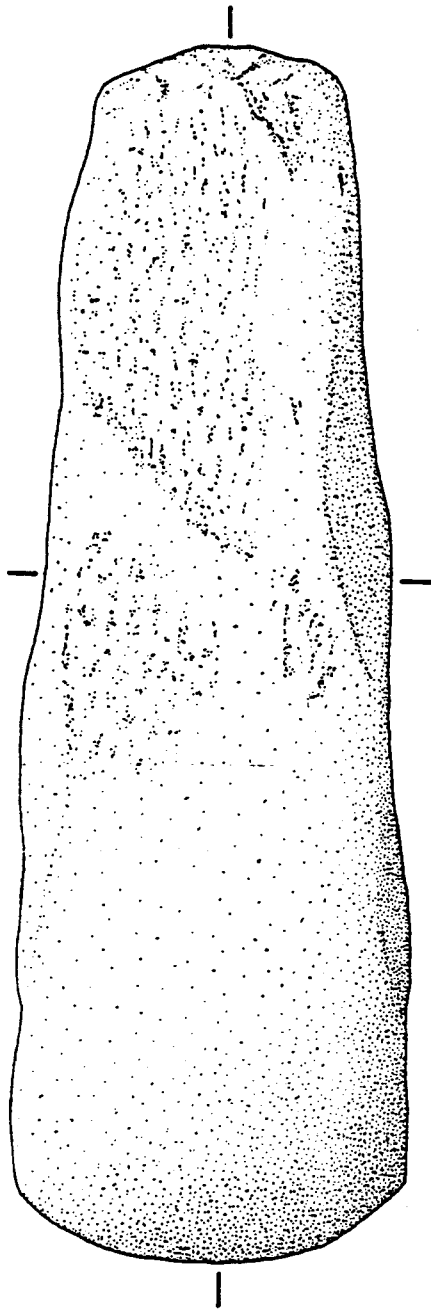

TR 34





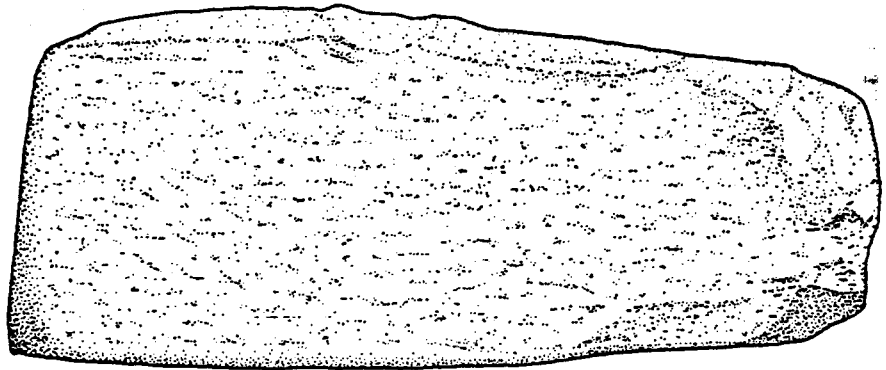
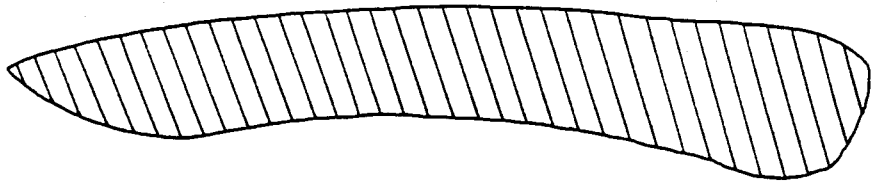
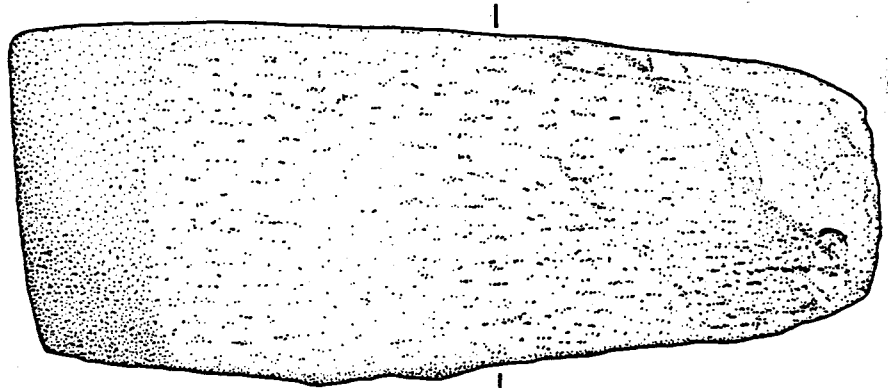
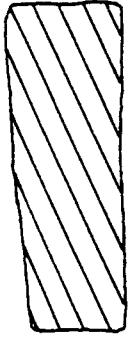

TR 40



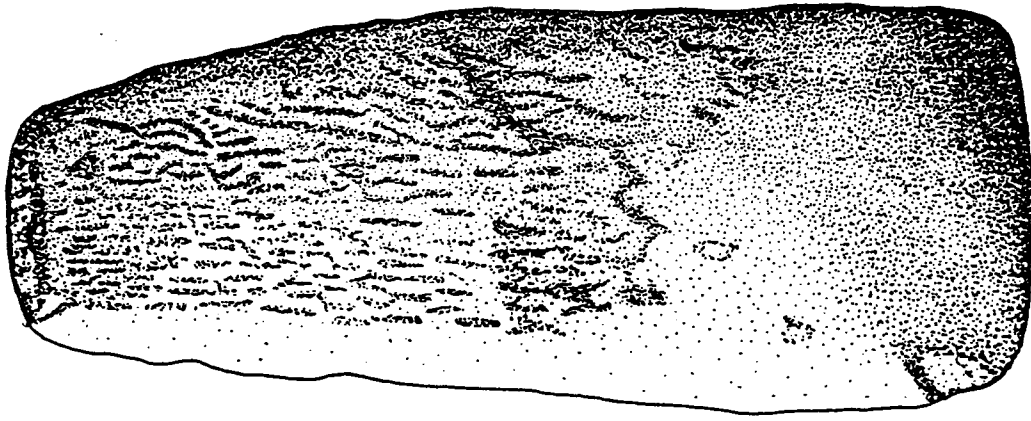

TR 36

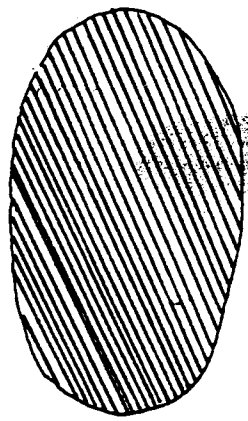
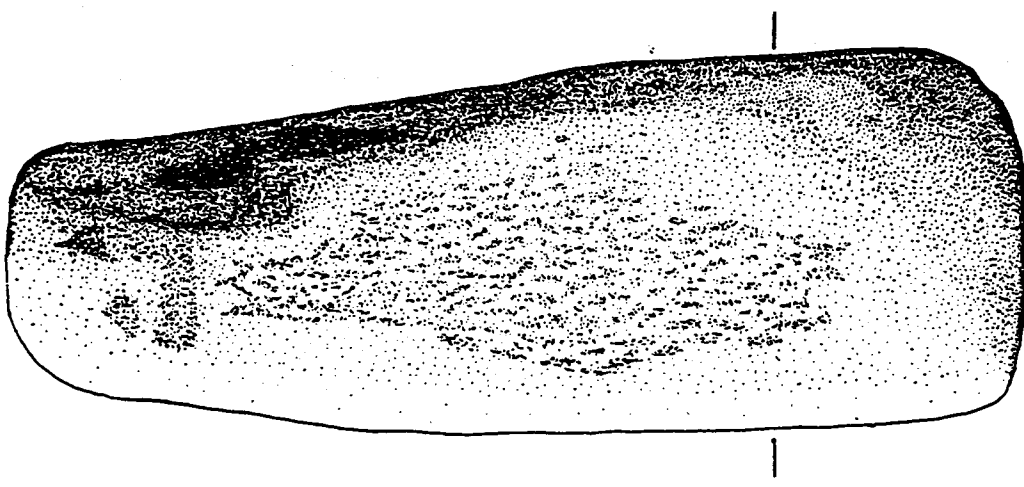
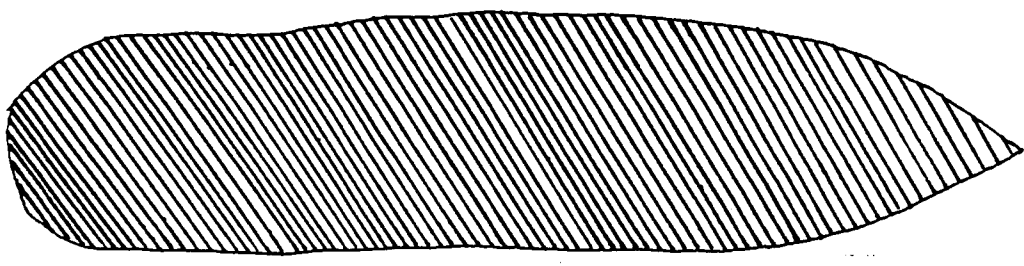

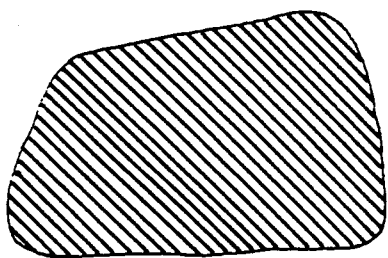
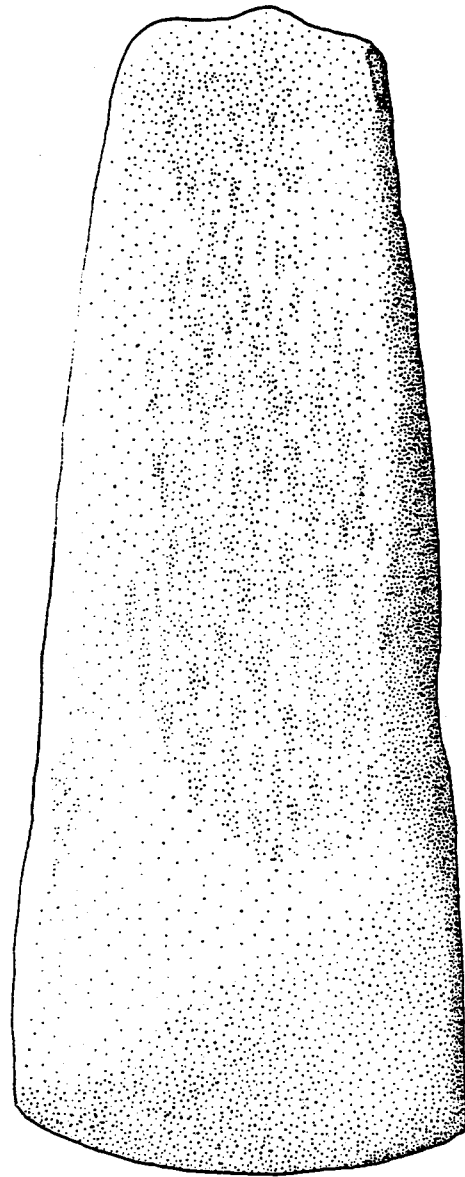
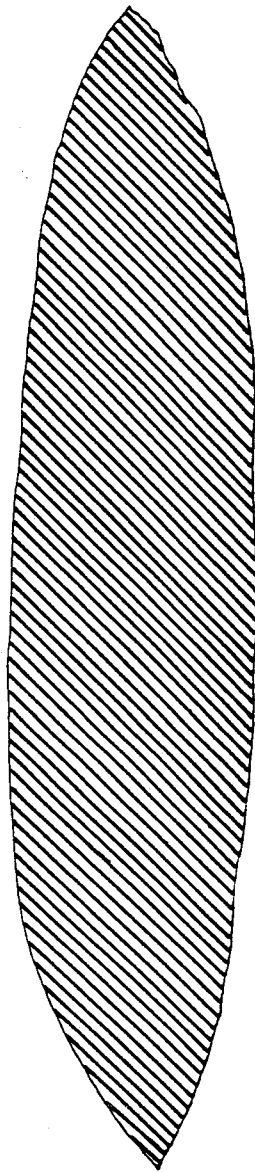
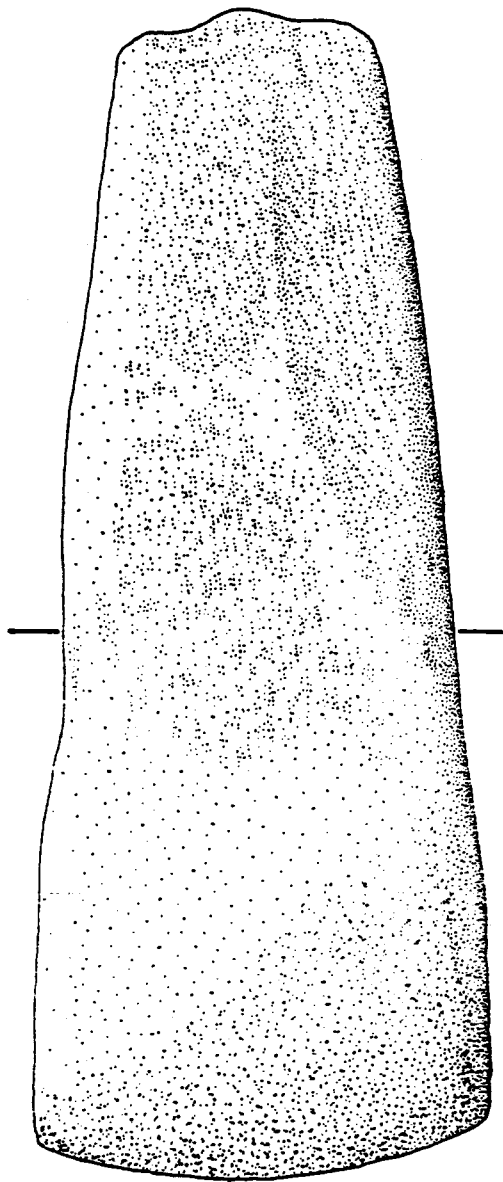

TR 35



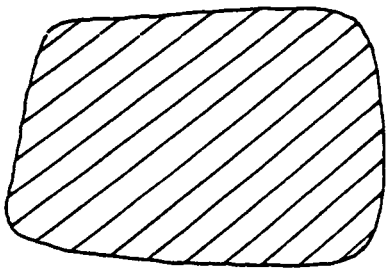
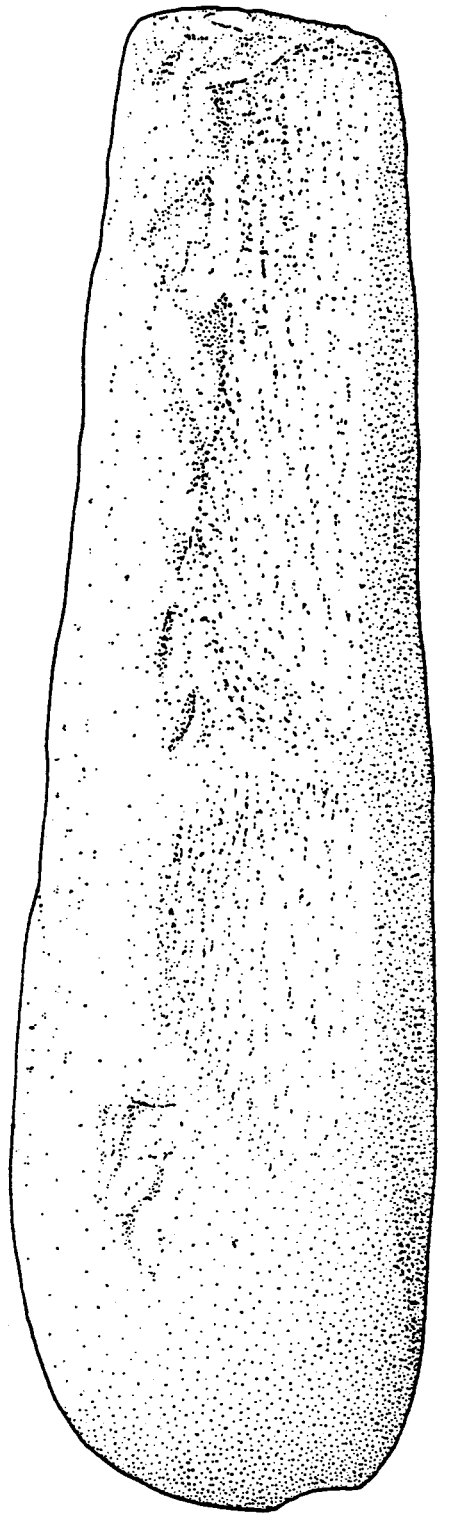
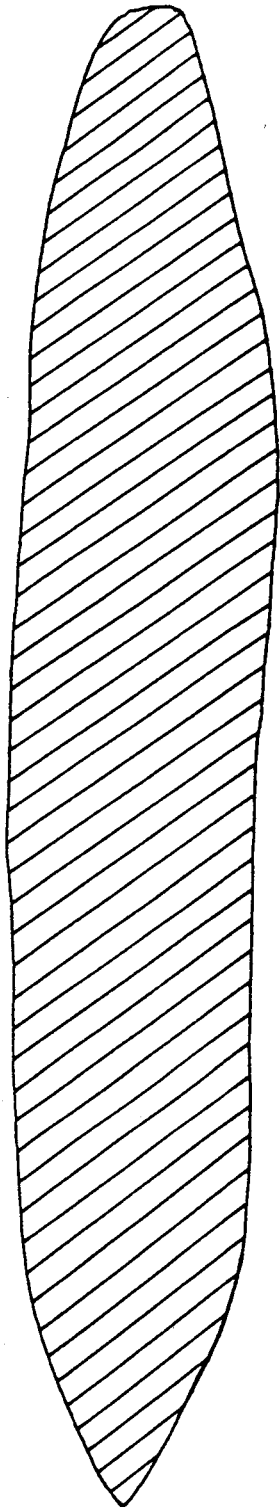

TR 33



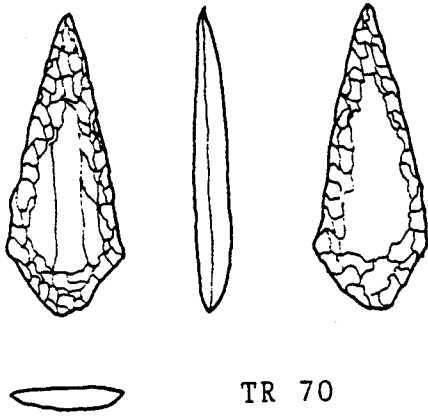

TR 70

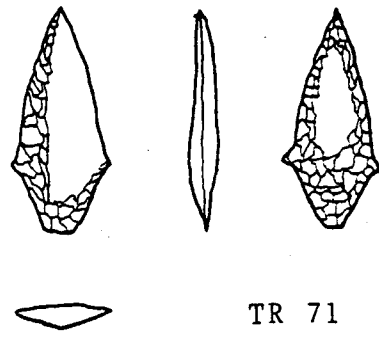

TR 71

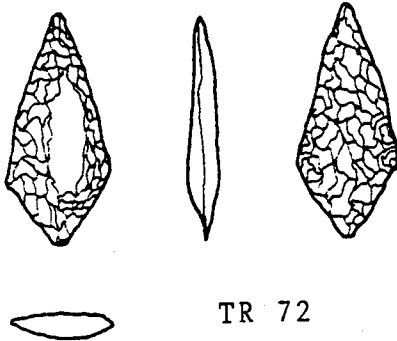

TR 72

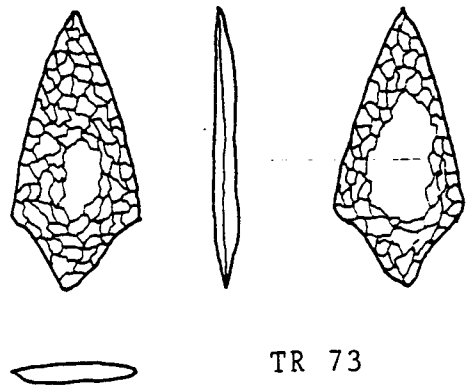

TR 73

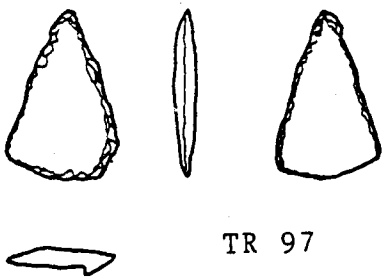

TR 97

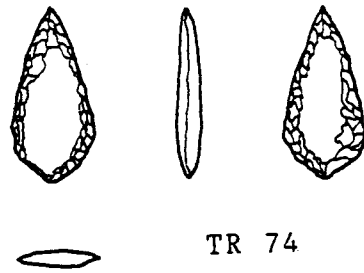

TR 74

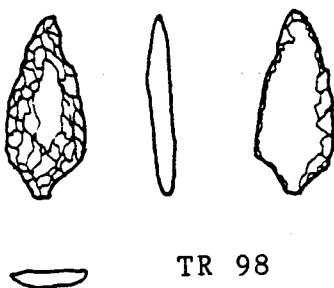

TR 98

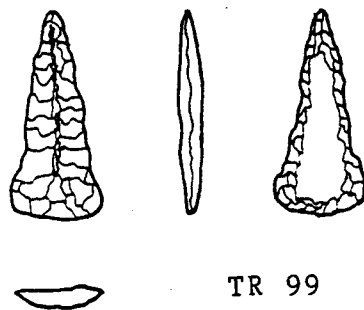

TR 99



TR 44

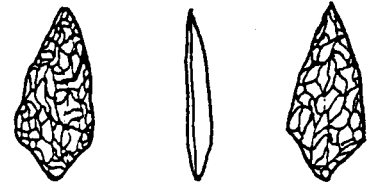

TR 104

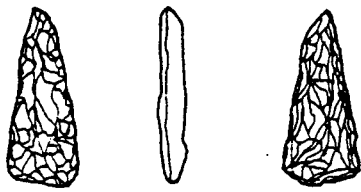

TR 79

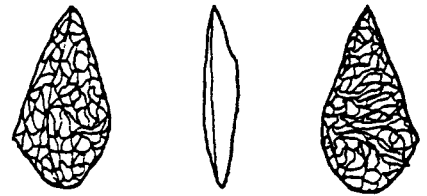

TR 105

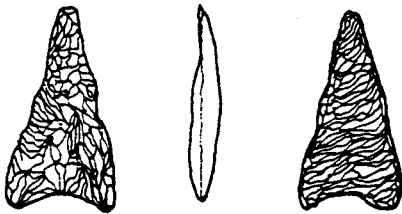
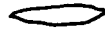

TR 45

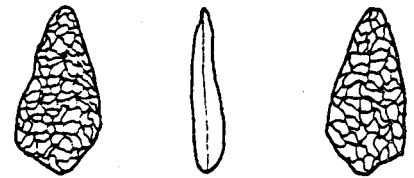

TR 46

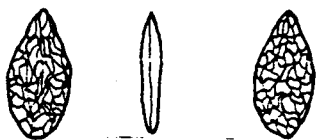

TR 47



TR 96



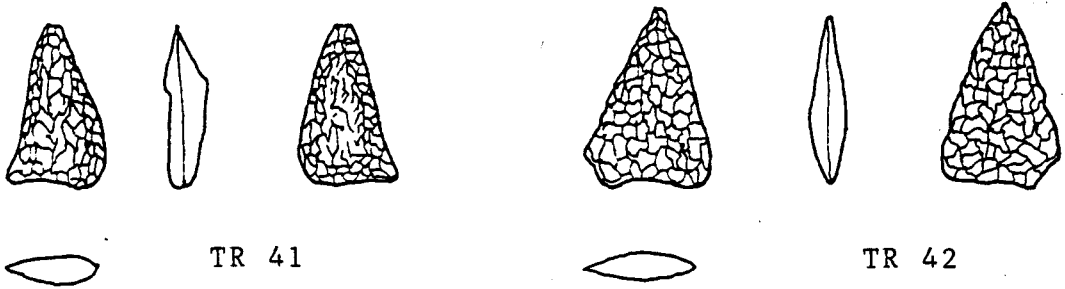

TR 41

TR 42

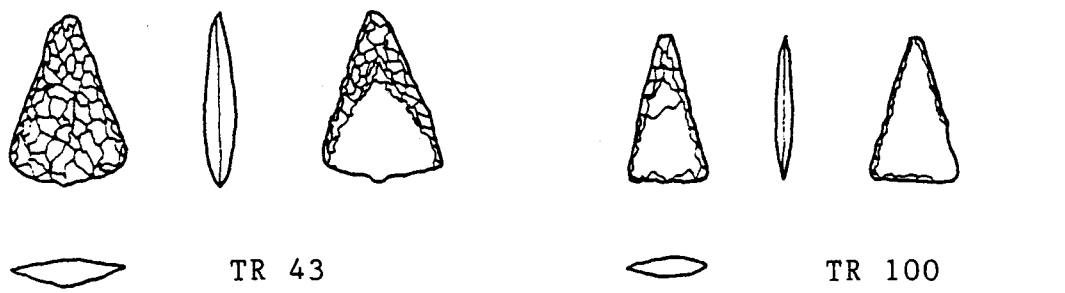

TR 43

TR 100



TR 101

TR 102

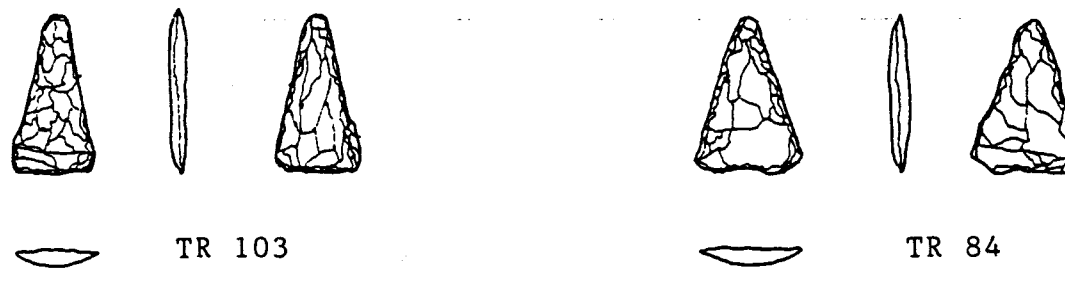

TR 103

TR 84

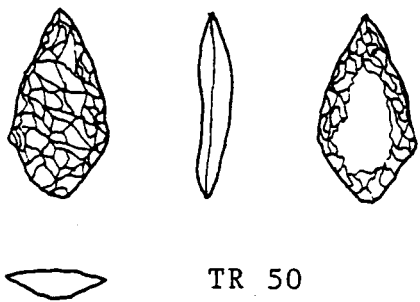

TR 50

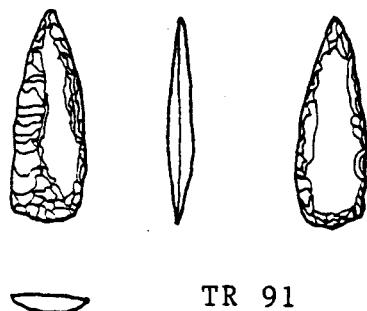

TR 91

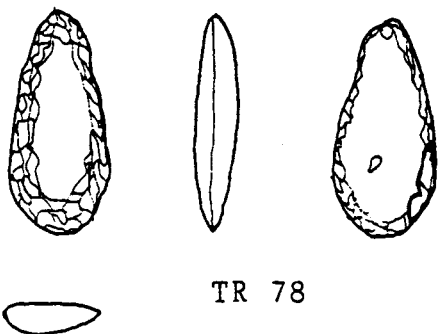

TR 78

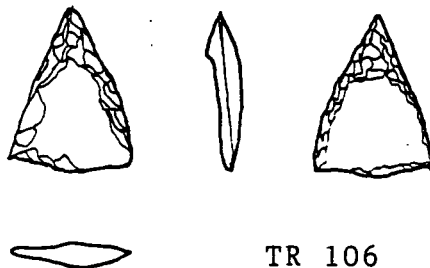

TR 106

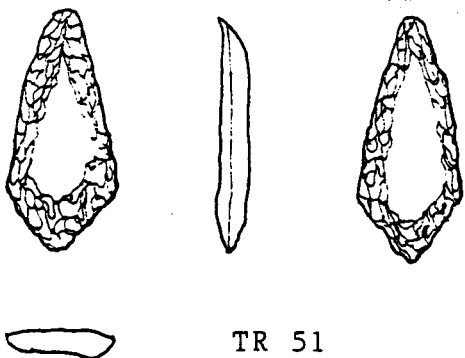

TR 51

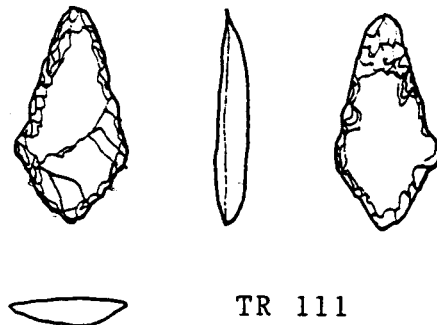

TR 111

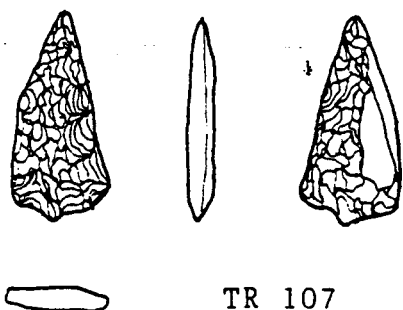

TR 107

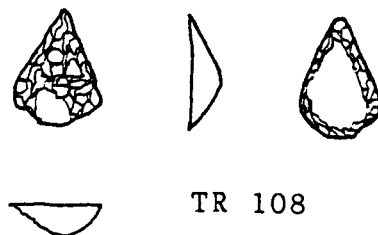

TR 108





TR 48

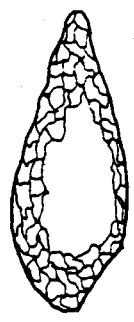
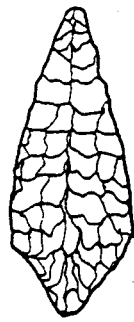

TR 85

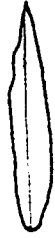
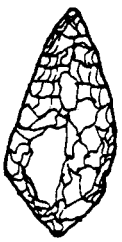

TR 49



TR 86



TR 75

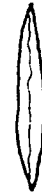
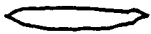

TR 90



TR 76

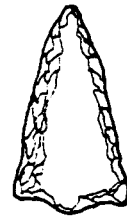

TR 77





TR 112



TR 56

TR 52



TR 57



TR 58

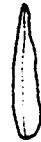

TR 113



TR 59

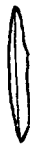

TR 60

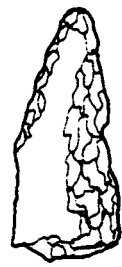

TR 61



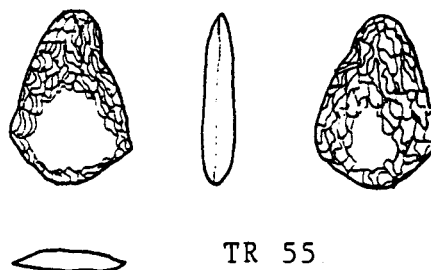
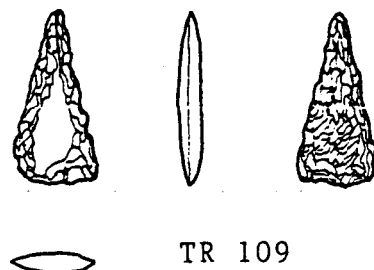
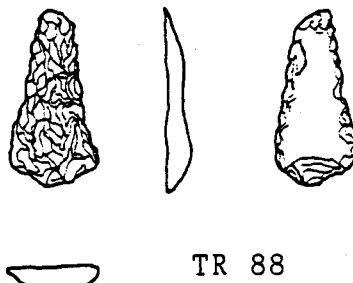
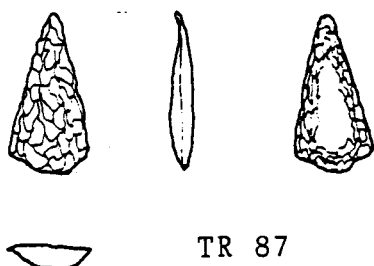
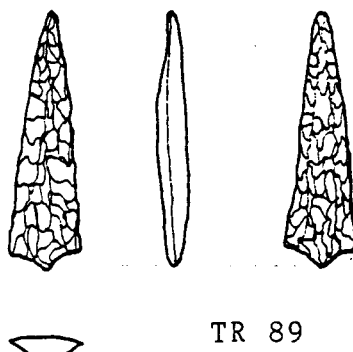
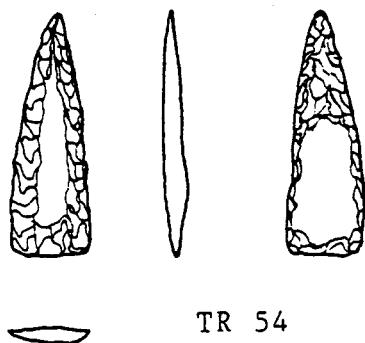
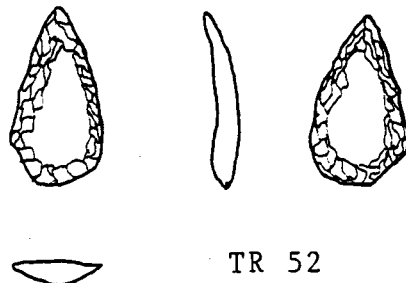
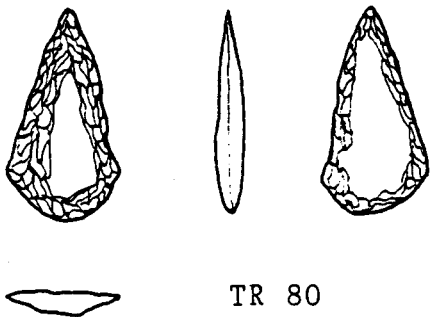



TR 63

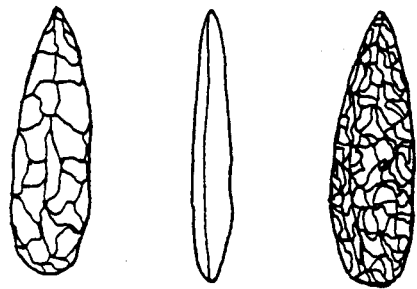

TR 93



TR 64

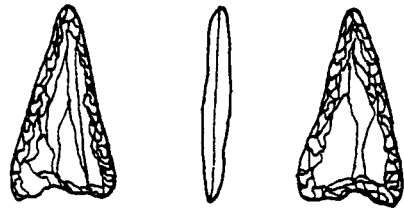

TR 110

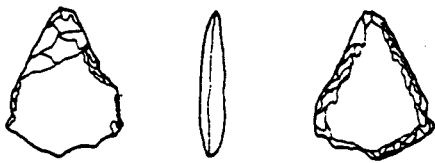

TR 94

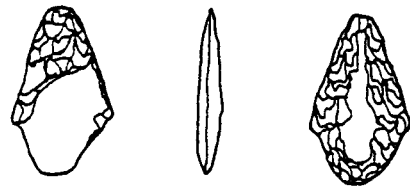
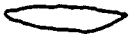

TR 65



TR 66

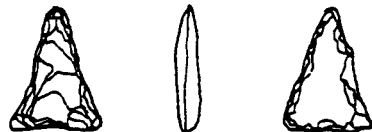

TR 67



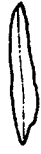

TR 114

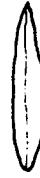

TR 115

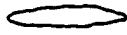

TR 81

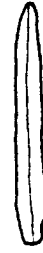

TR 83



TR 82

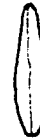

TR 62



TR 116



TR 92

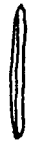

TR 117



TR 68

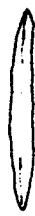

TR 118

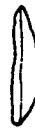

TR 95



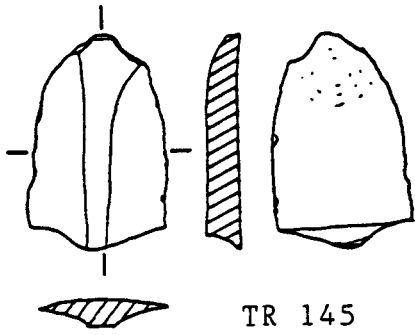

TR 145

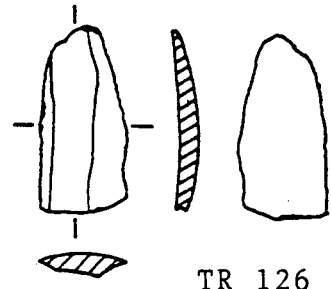

TR 126

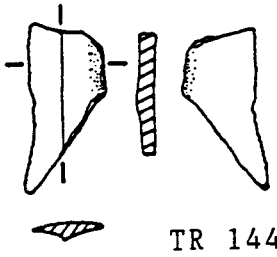

TR 144

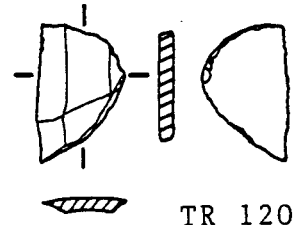

TR 120

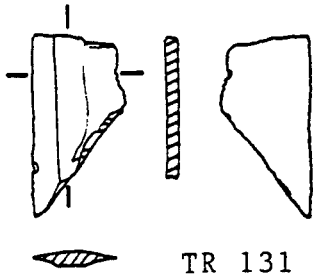

TR 131

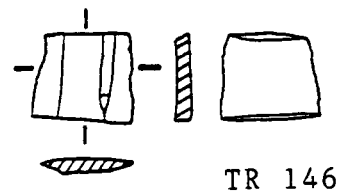

TR 146

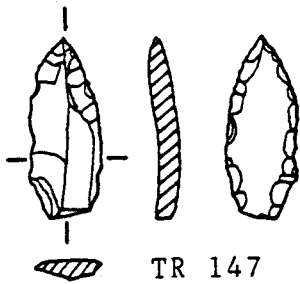

TR 147

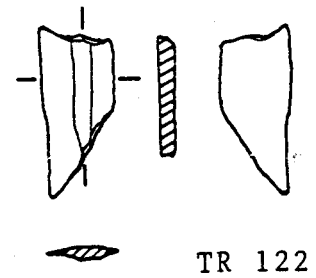

TR 122

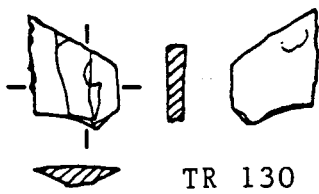

TR 130

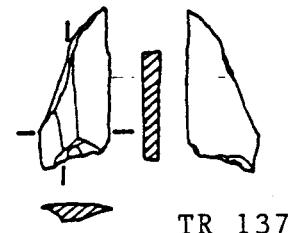

TR 137



TR 12

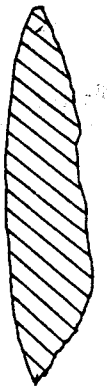
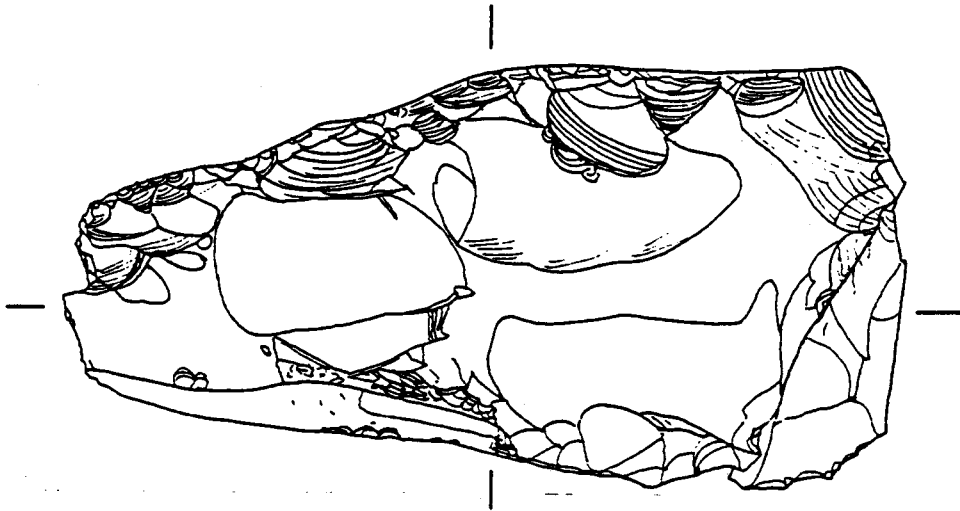
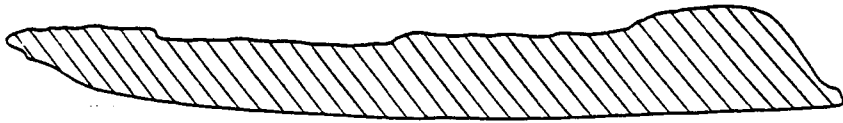
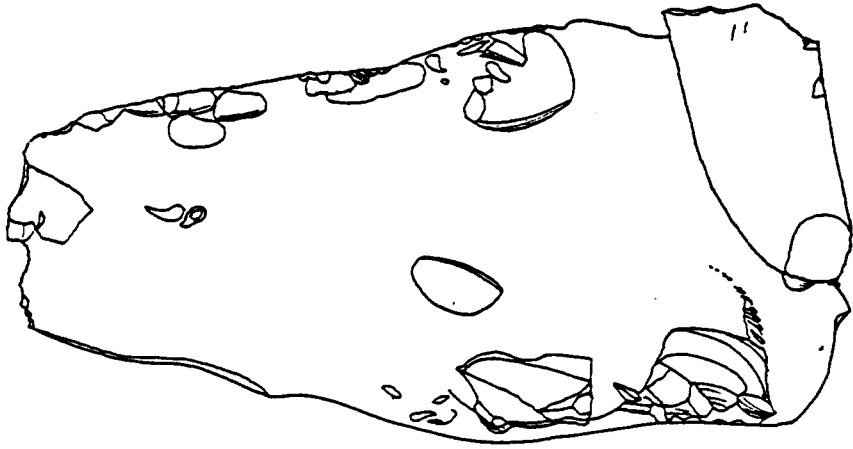



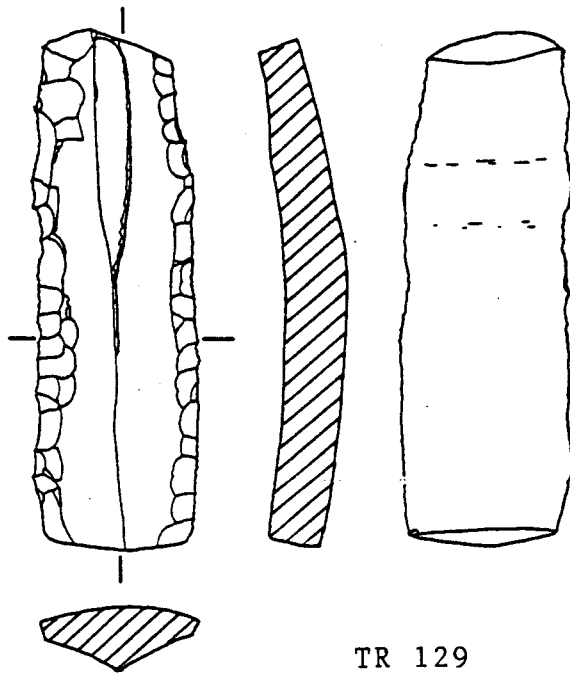

TR 129

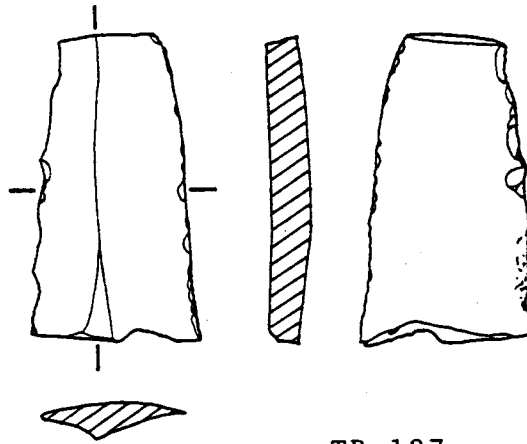

TR 127

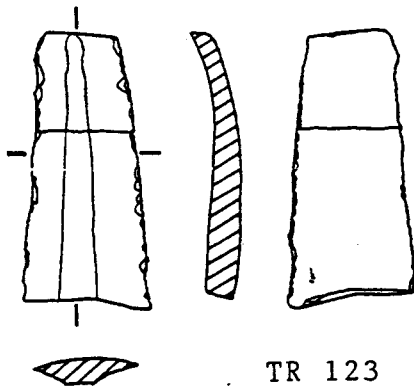

TR 123

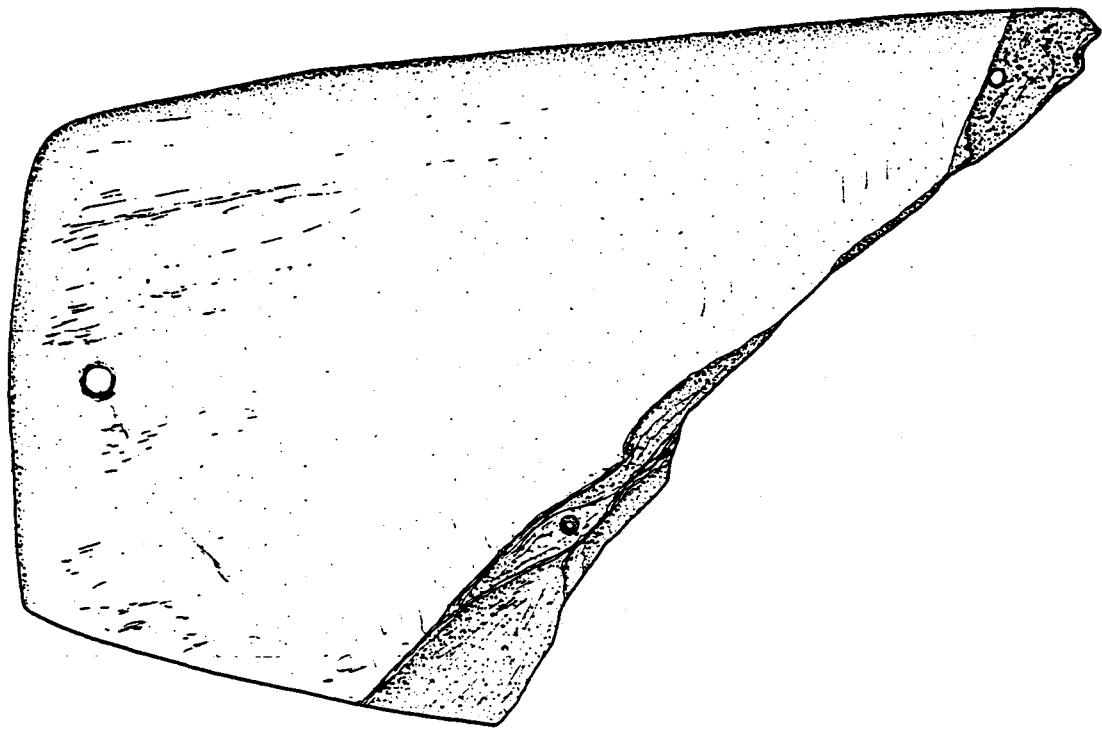

TR 52

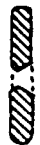
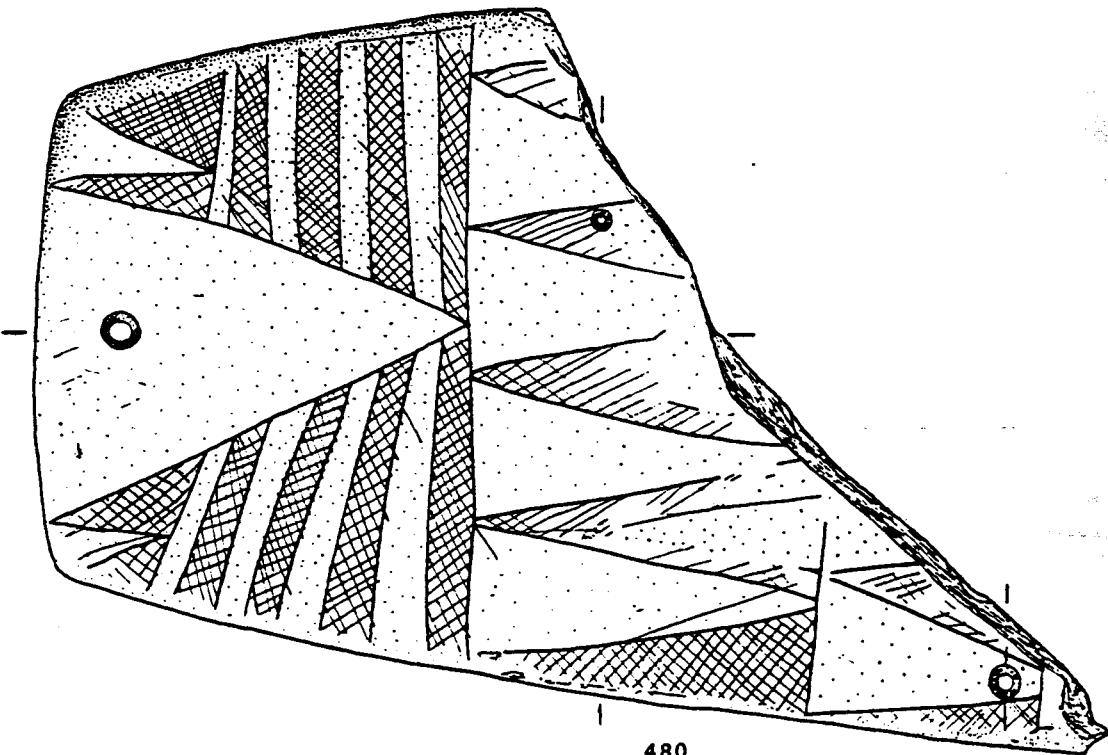

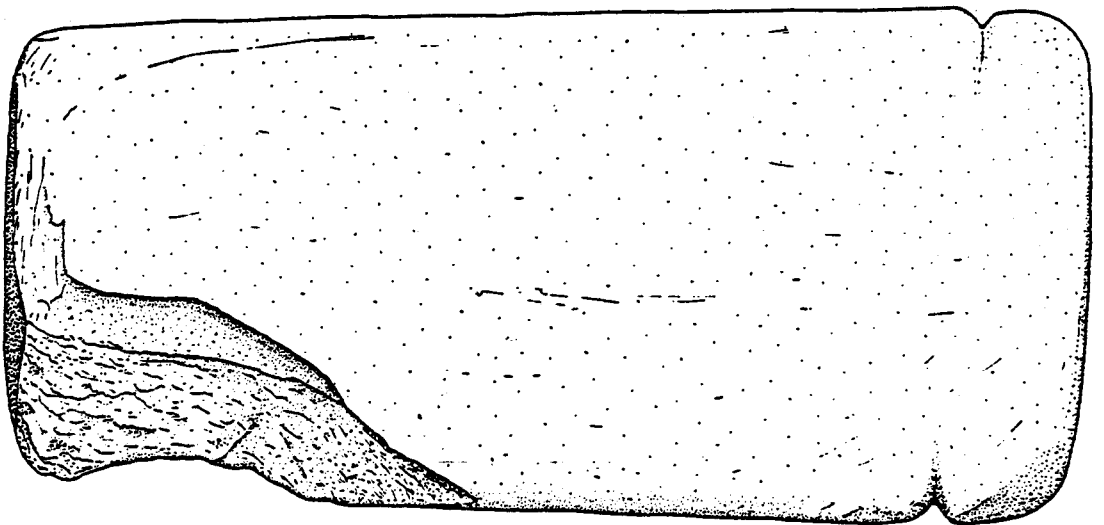
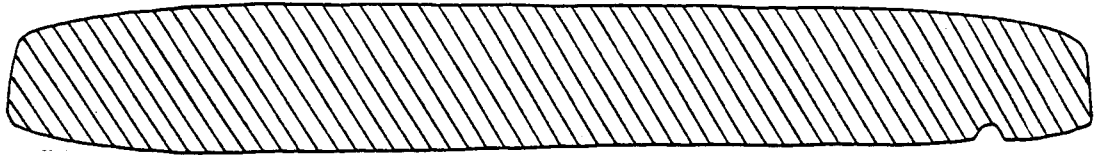
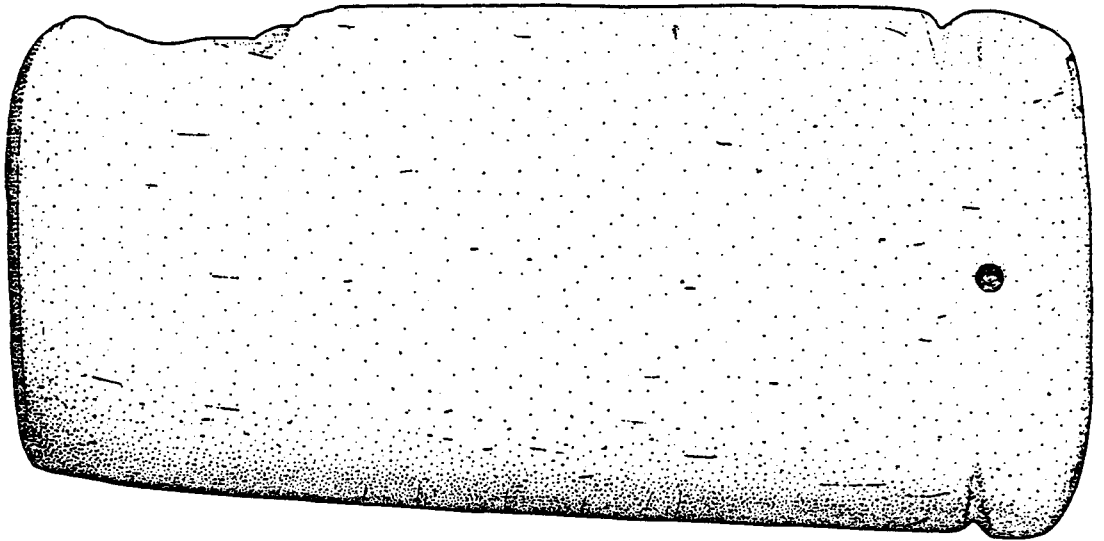

TR 26

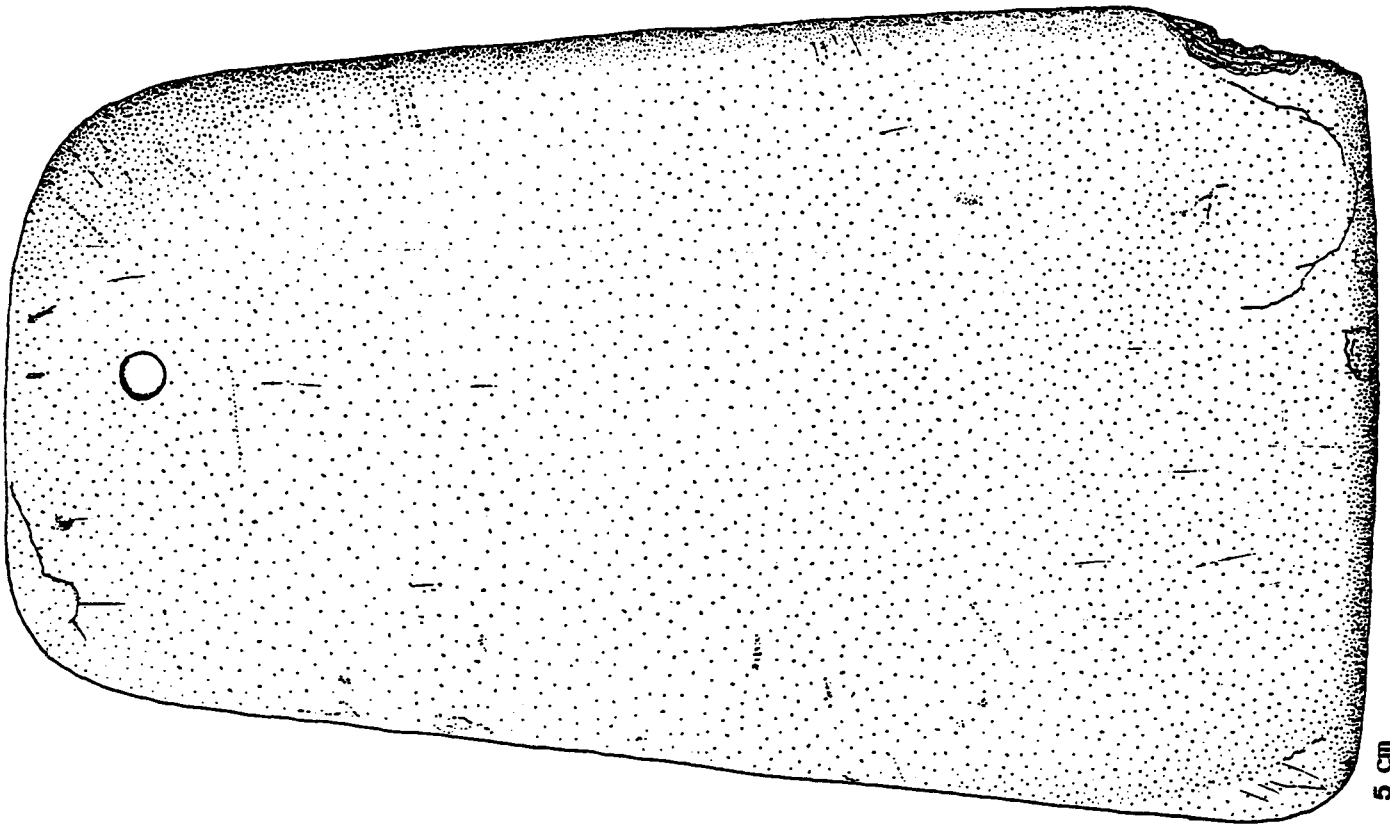

TR 28

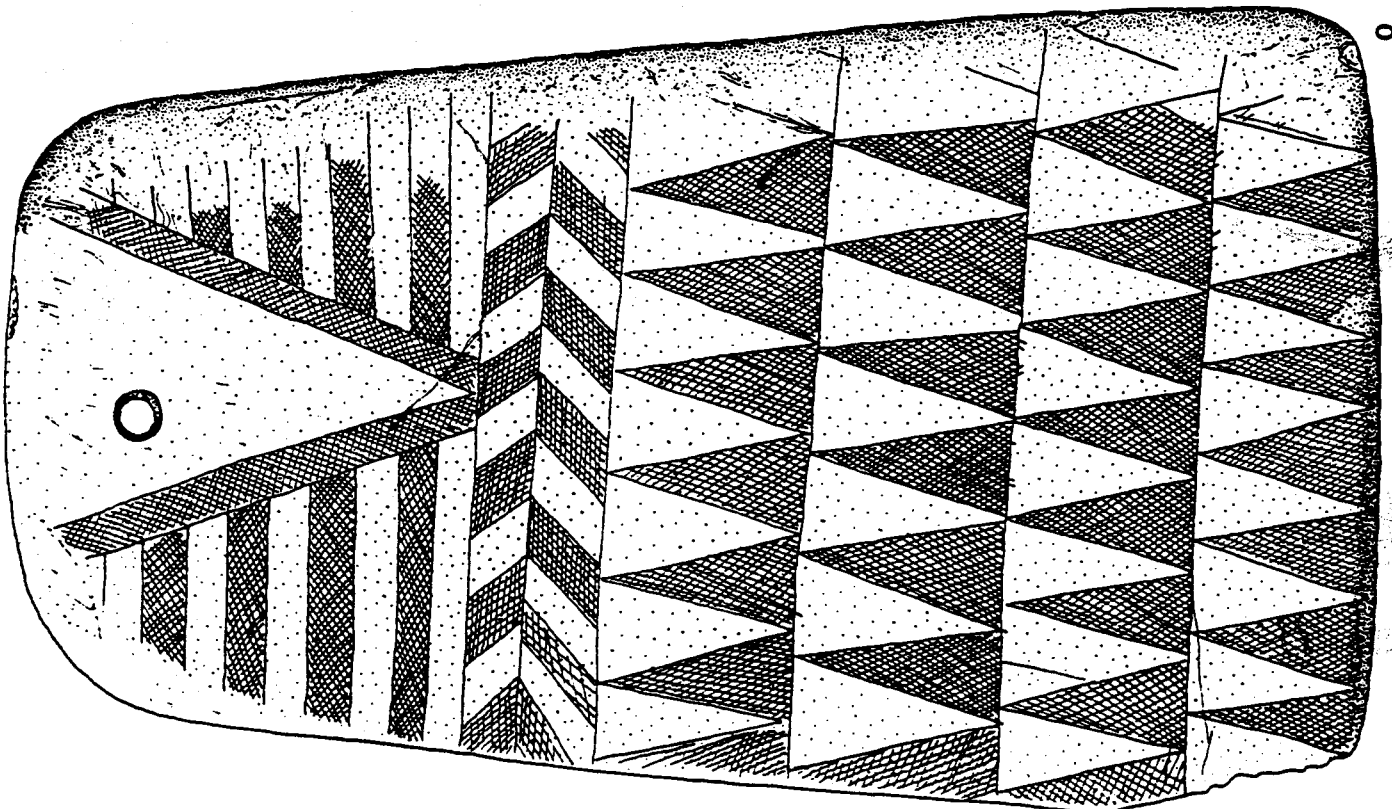
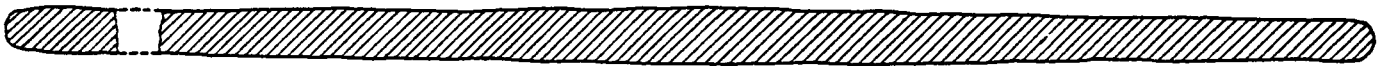

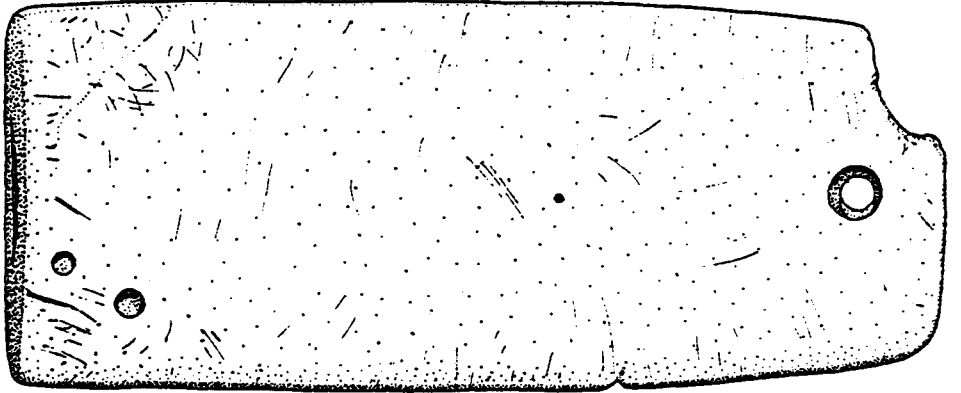
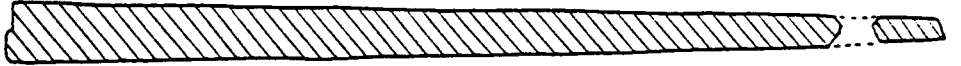
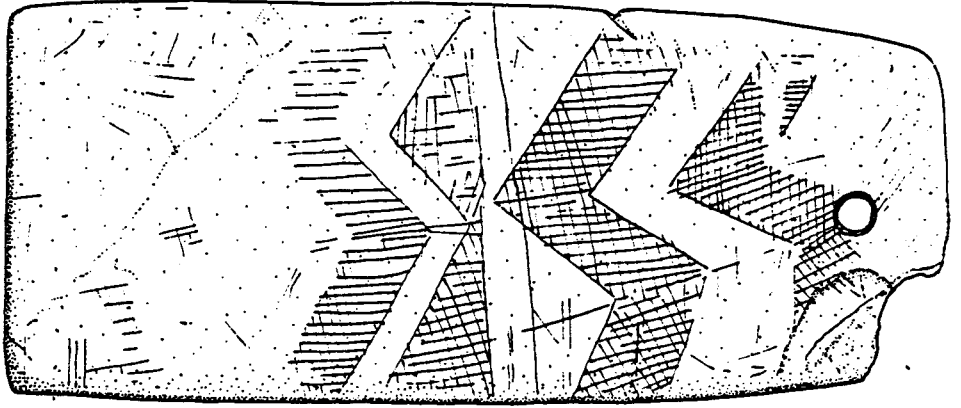

TR 24

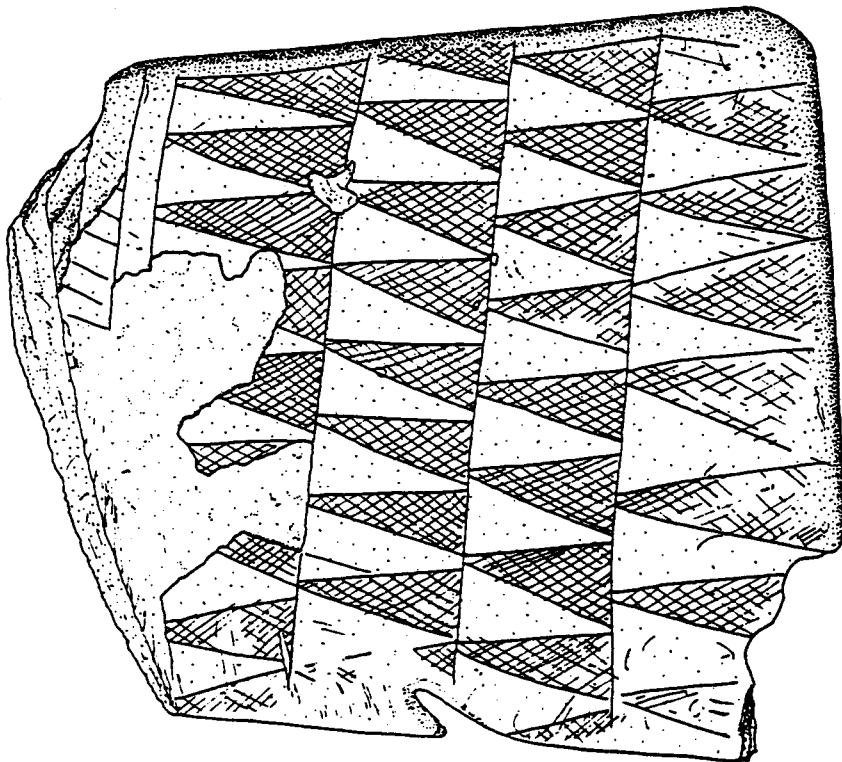
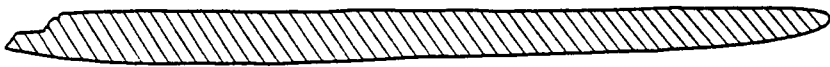
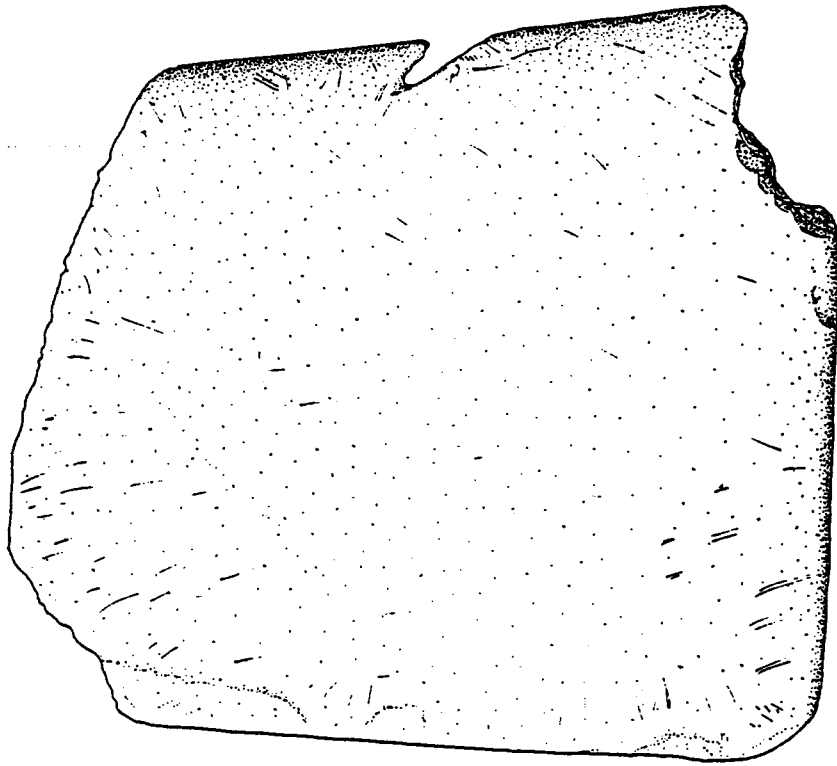

TR 25



0  
4 cm

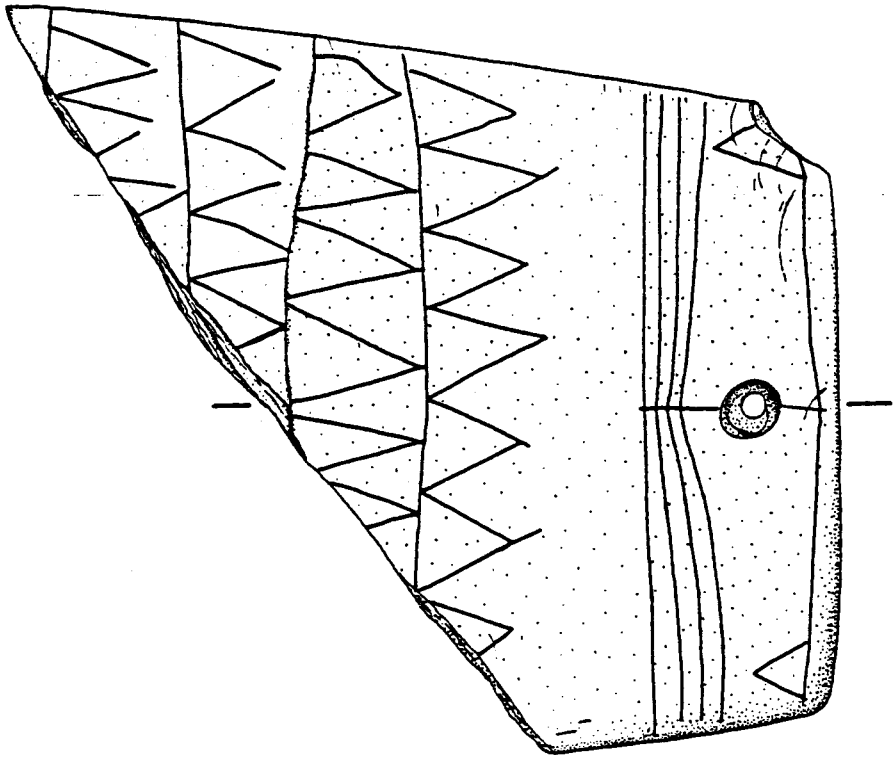

TR 29

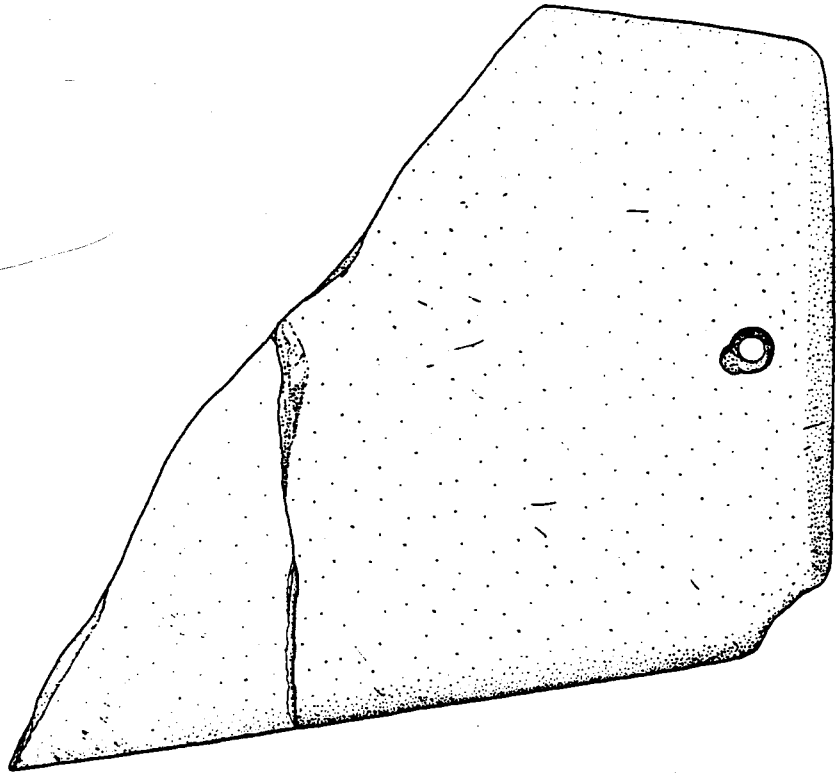

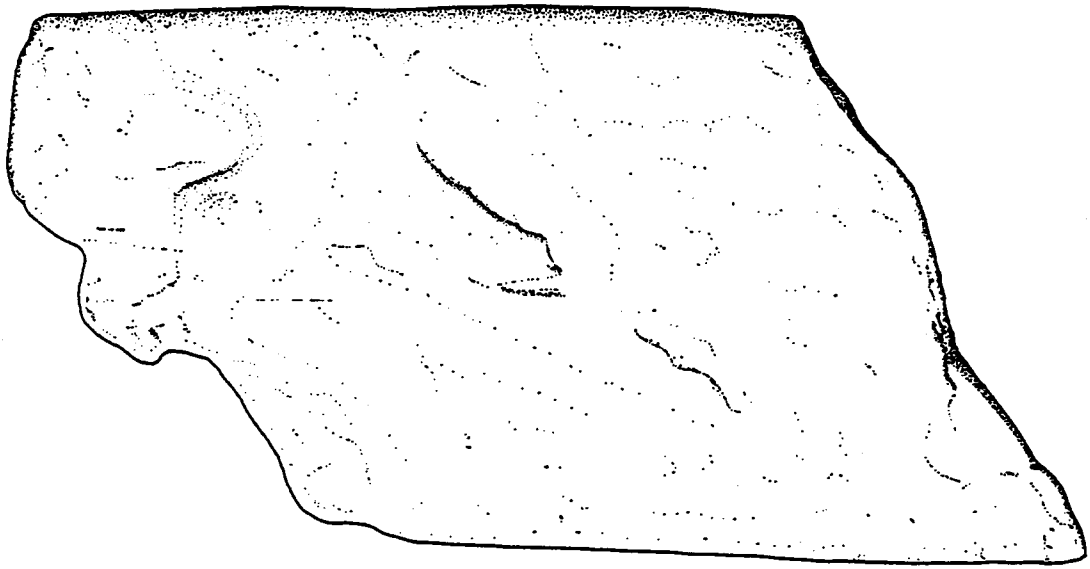

TR 31

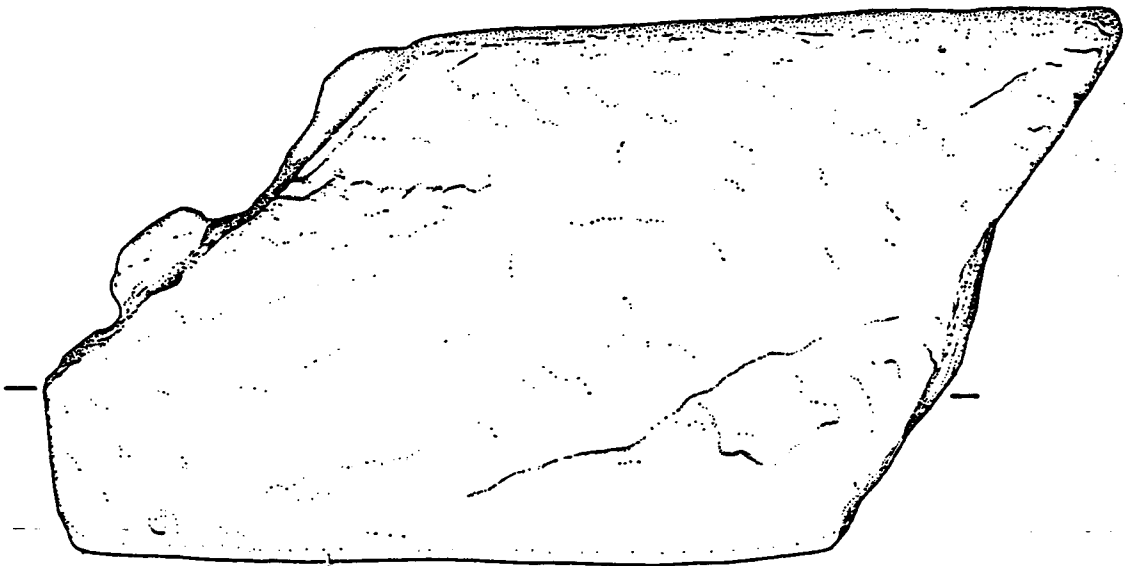





ANTA  
do  
**VALE DA ESTRADA**



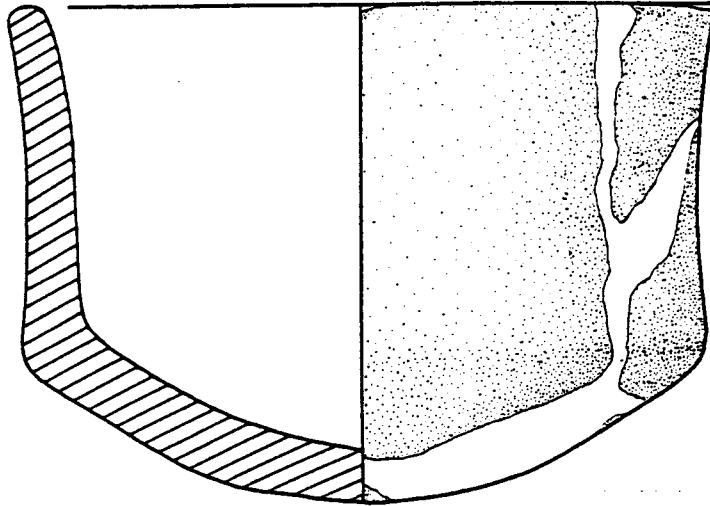

AVE 22

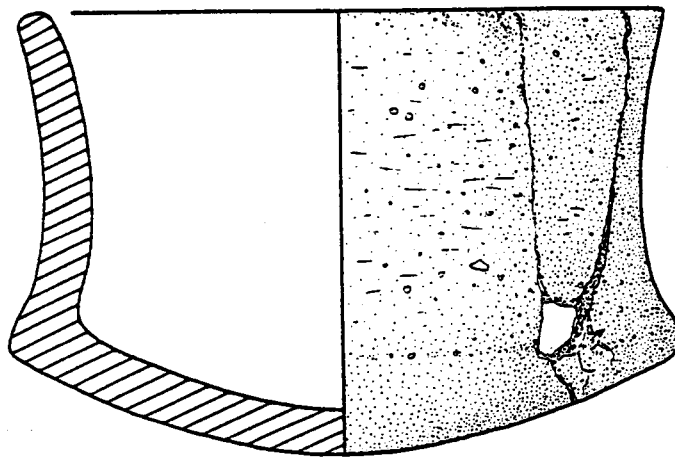

AVE 23



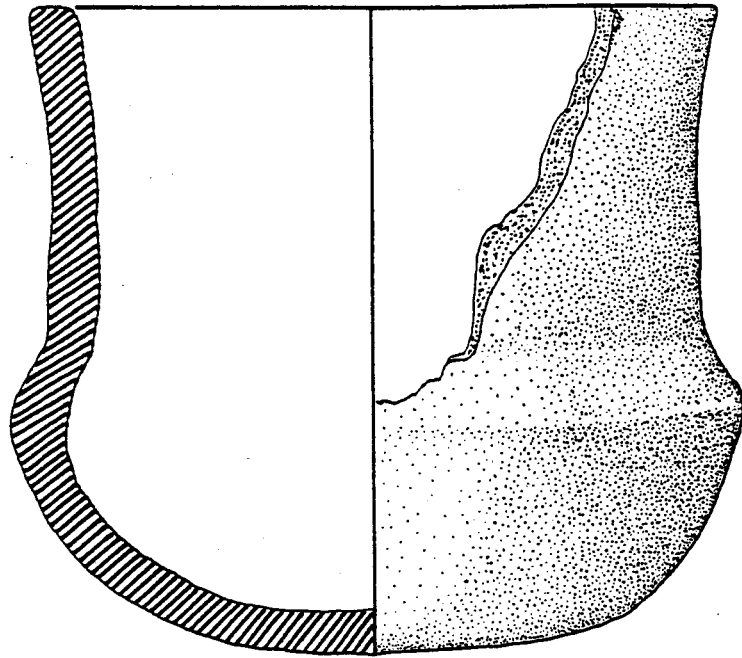

AVE 24

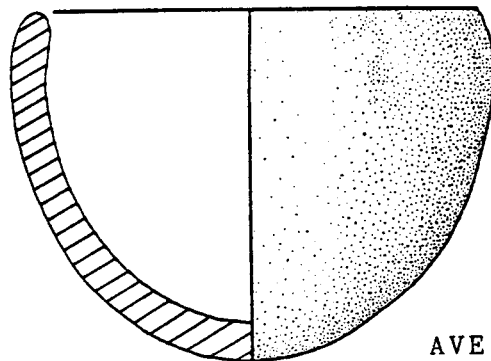

AVE 31

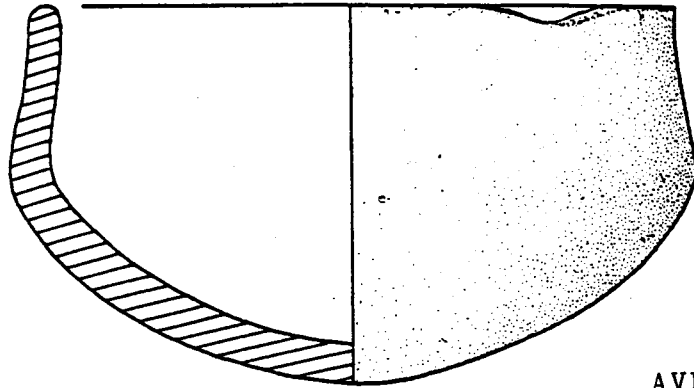

AVE 67

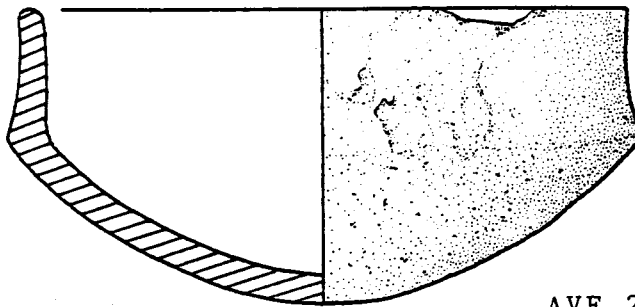

AVE 25

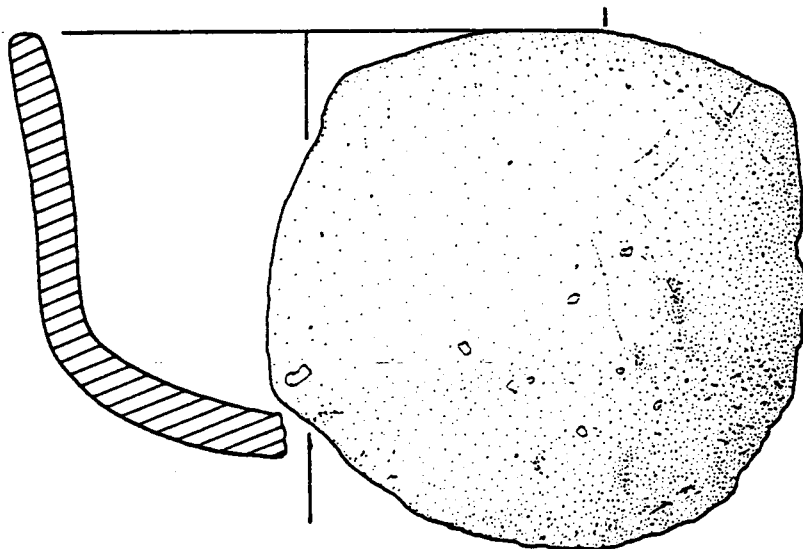

AVE 29



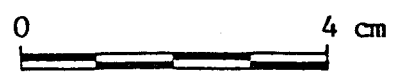
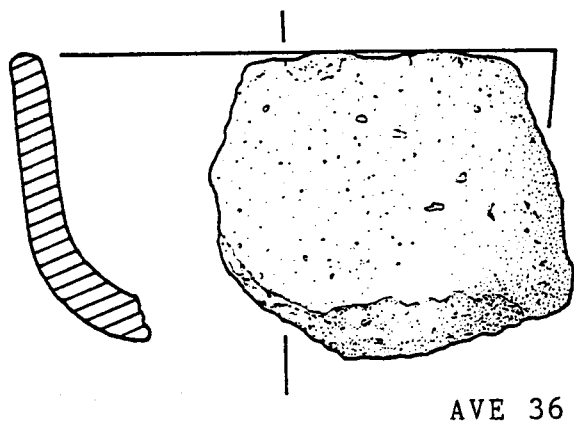
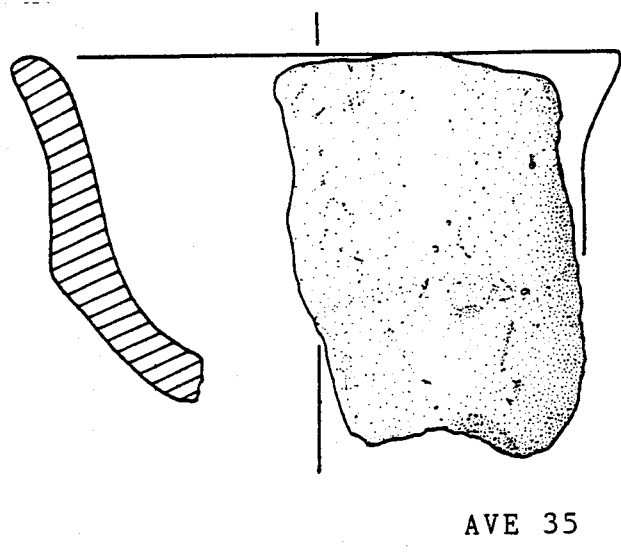
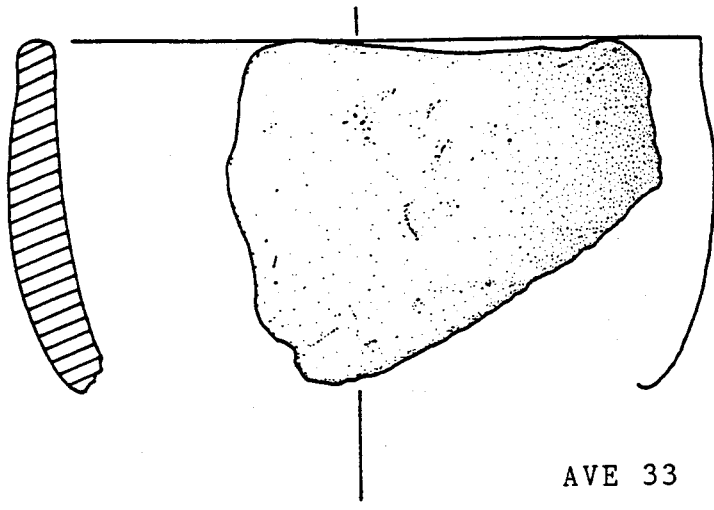

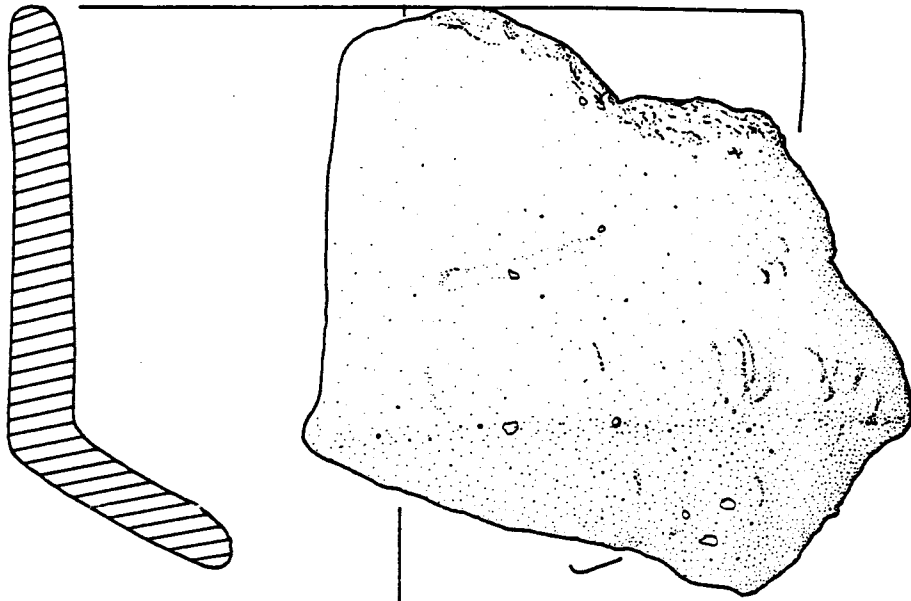

AVE 30

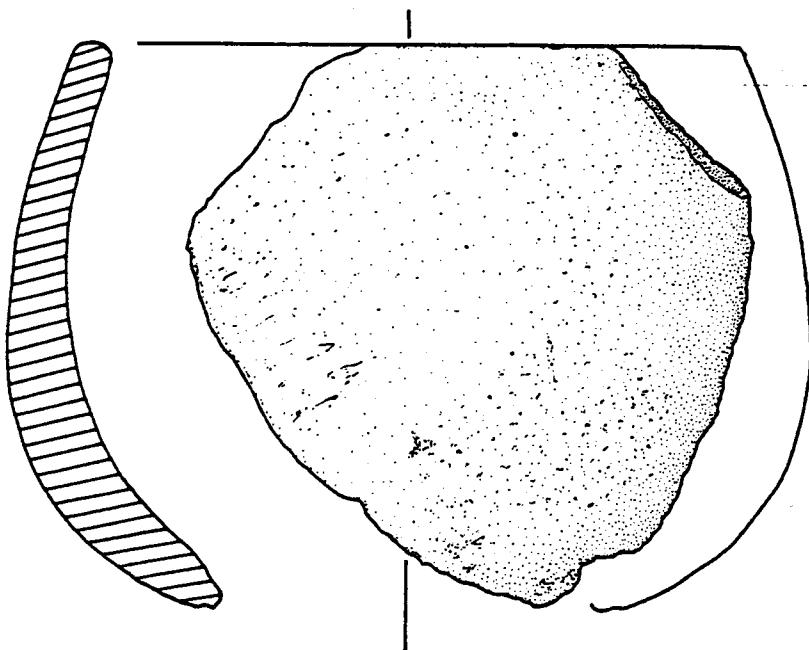

AVE 32





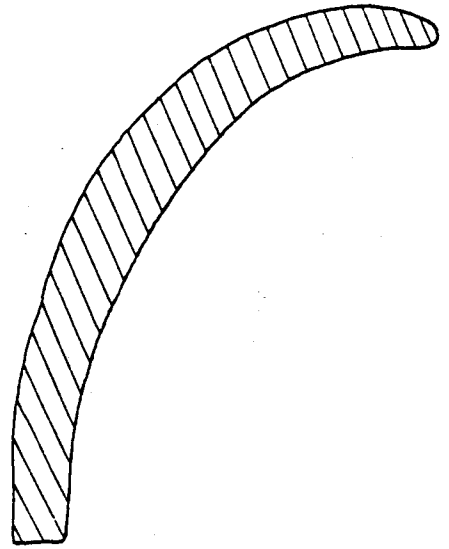
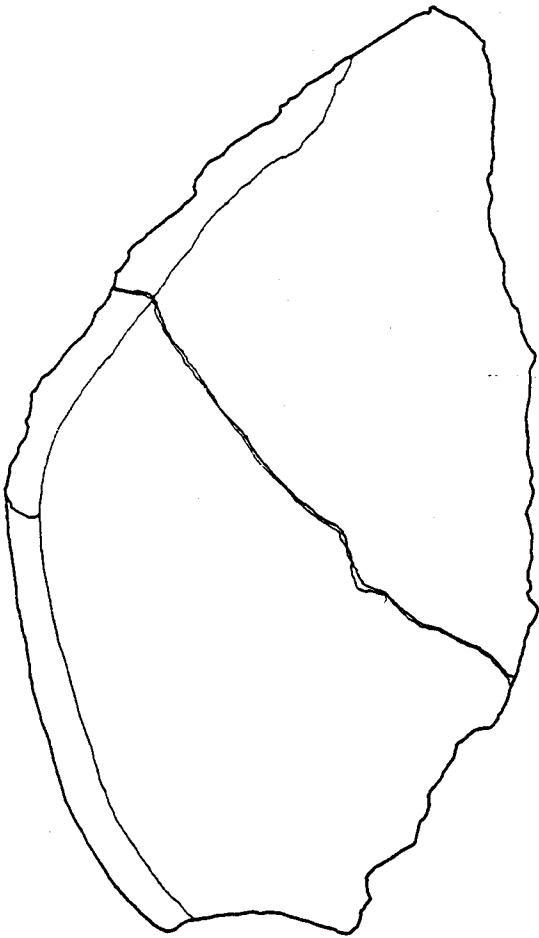

AVE 26



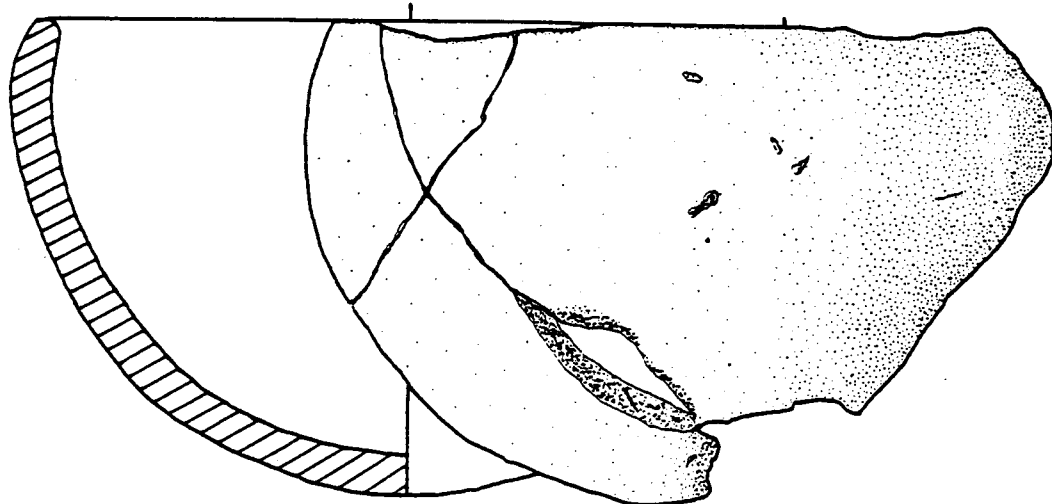

AVE 28

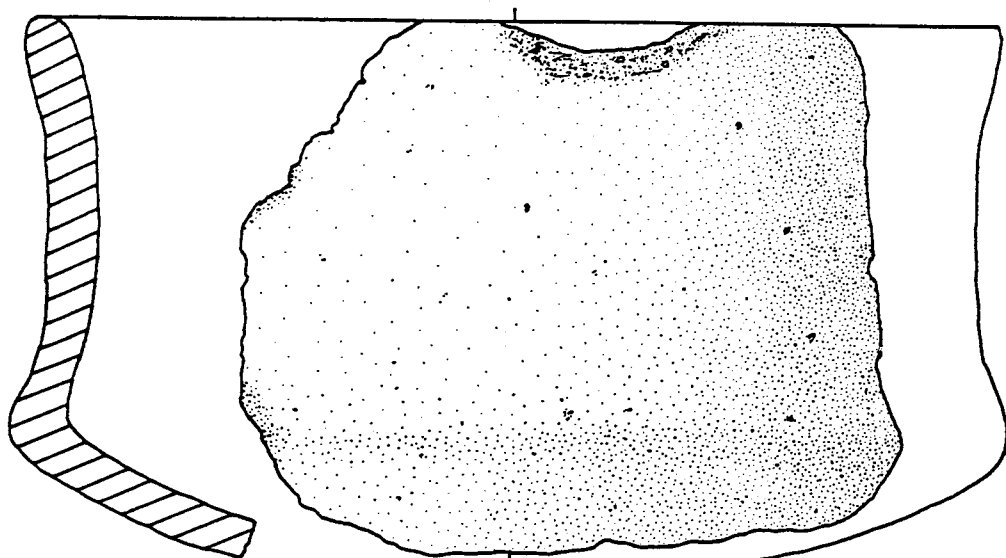

AVE 27



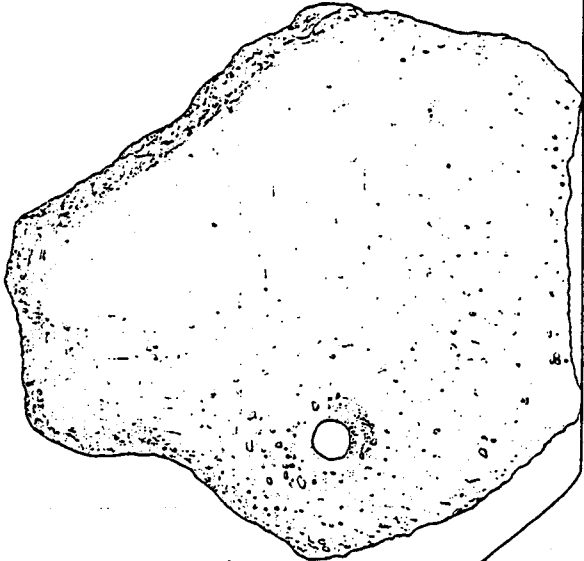
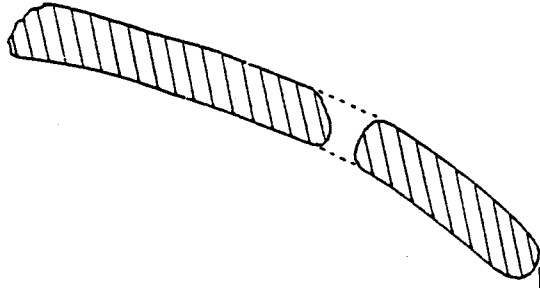

AVE 66

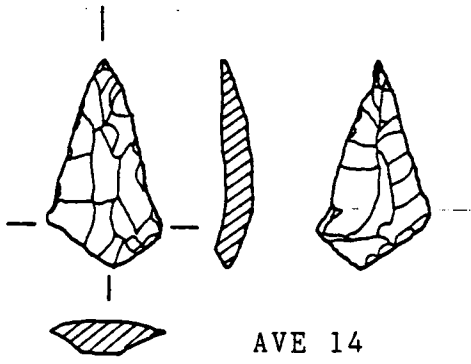

AVE 14

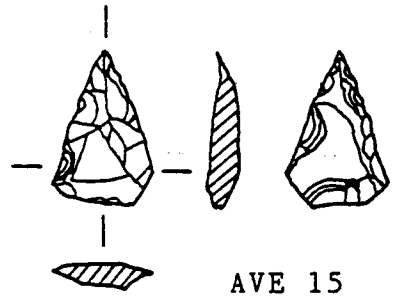

AVE 15

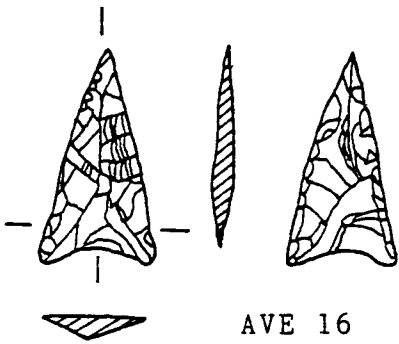

AVE 16

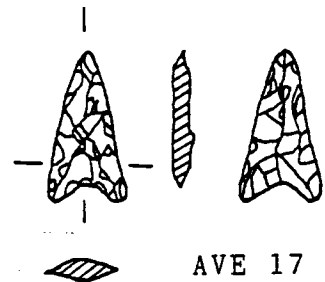

AVE 17

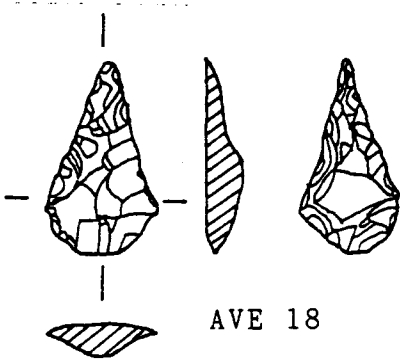

AVE 18

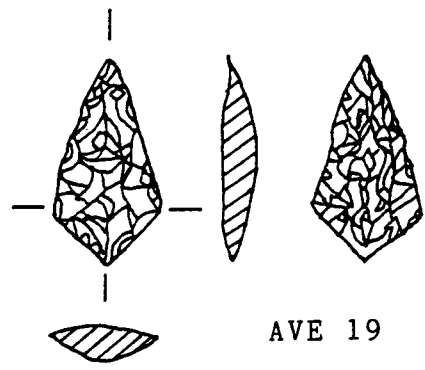

AVE 19



AVE 20

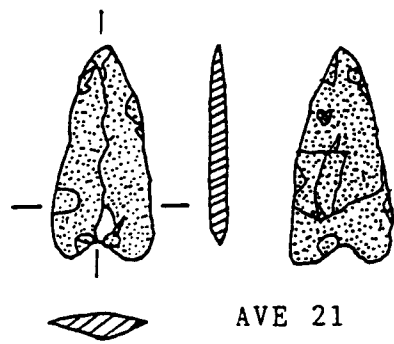

AVE 21

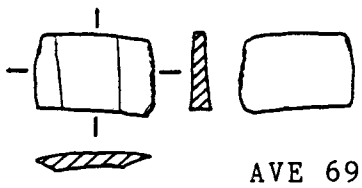
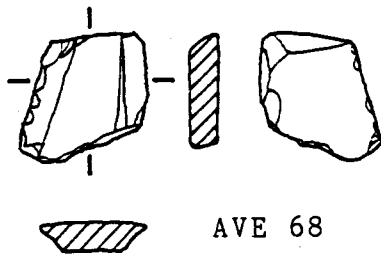
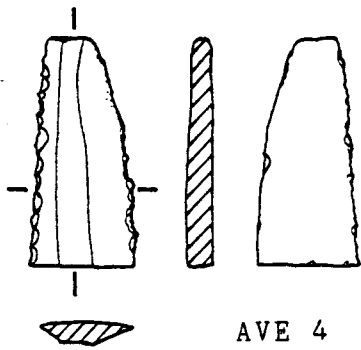
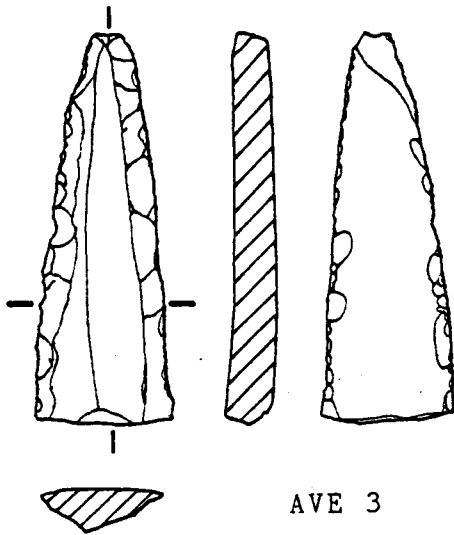

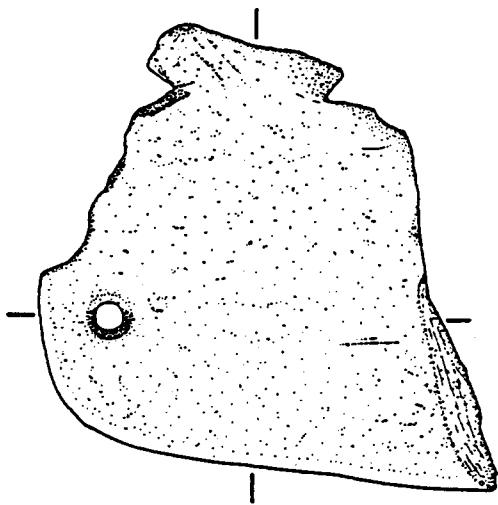
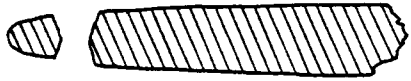
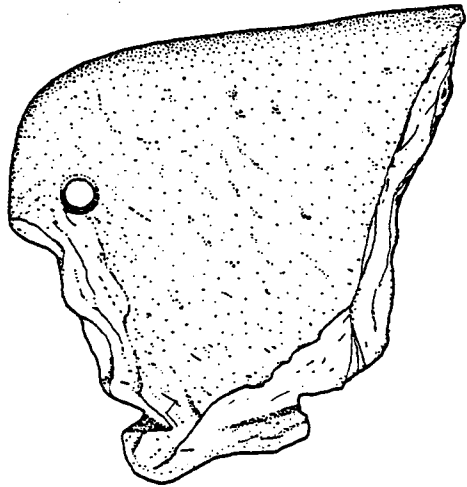

AVE 7



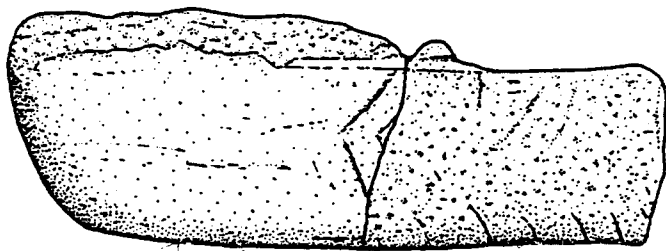
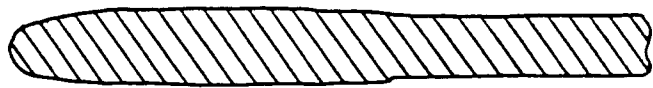
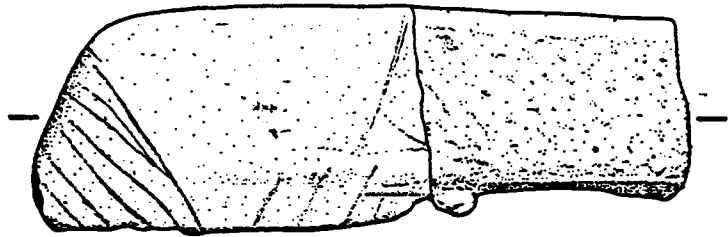

AVE 5



**MENIR**  
**do**  
**CARVALHAL**





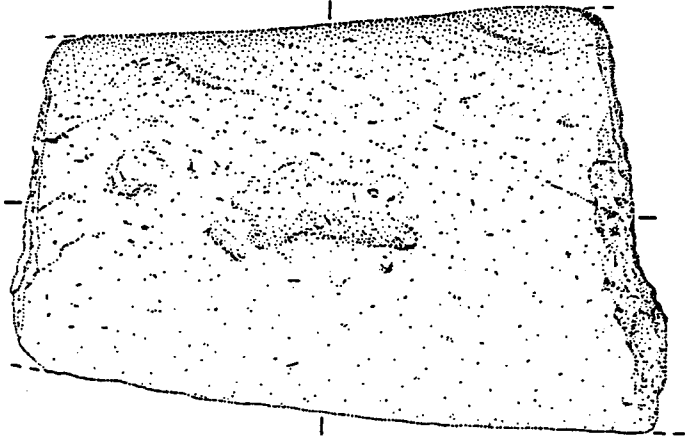
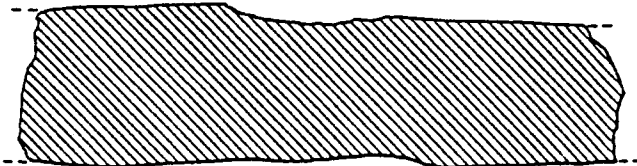
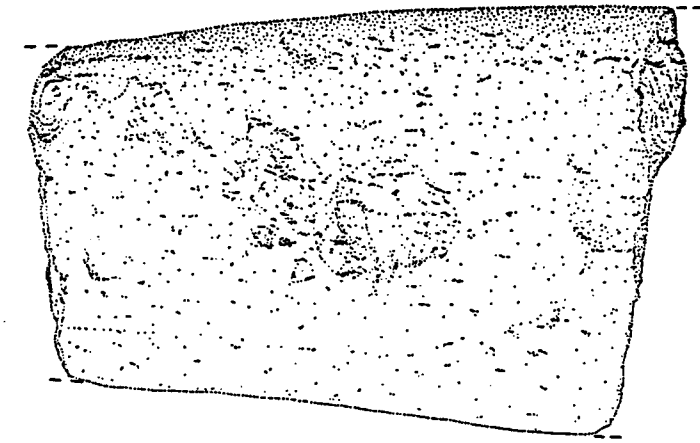

MC1

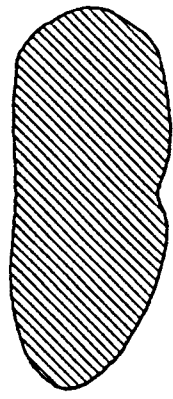

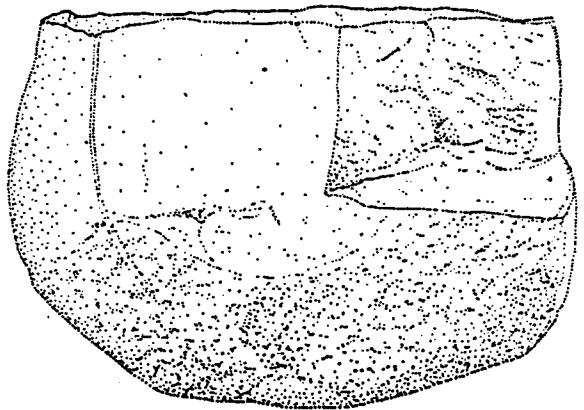
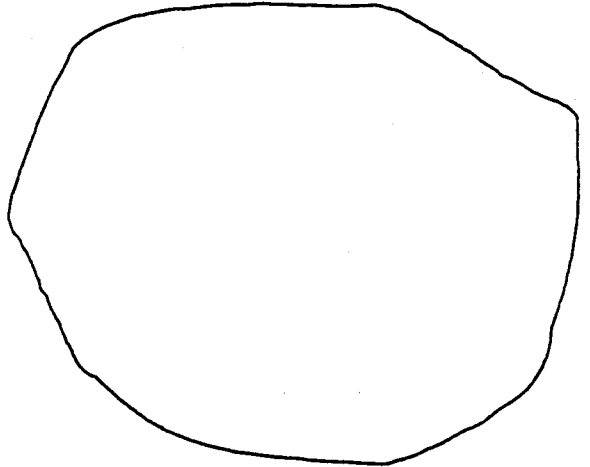
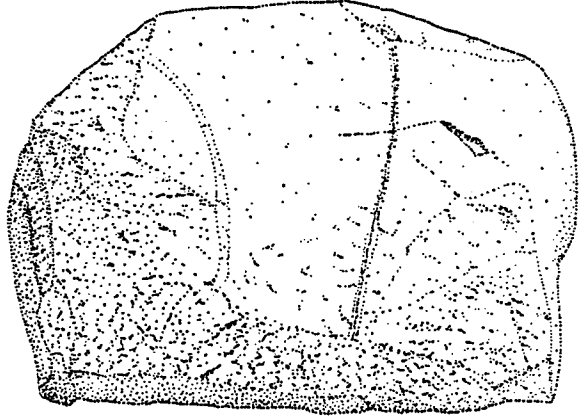
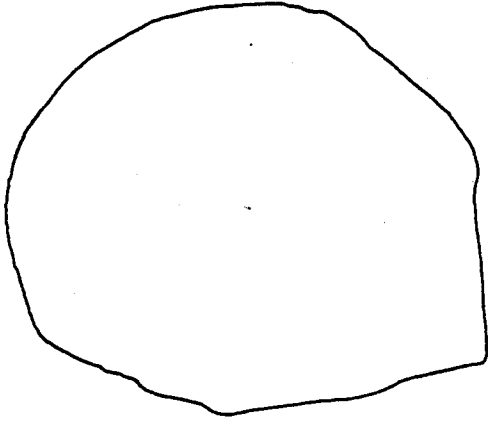

MC2

1

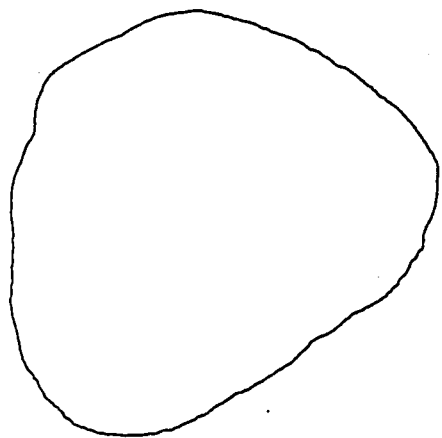
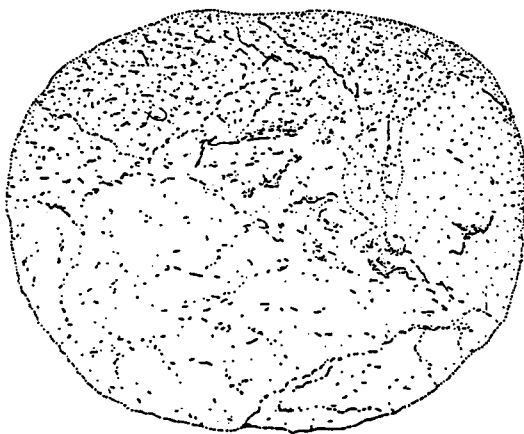
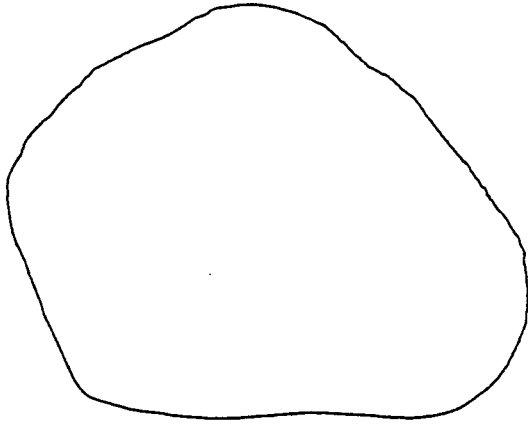
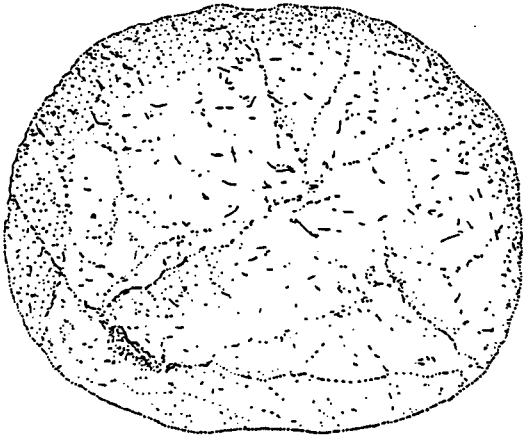

MC3



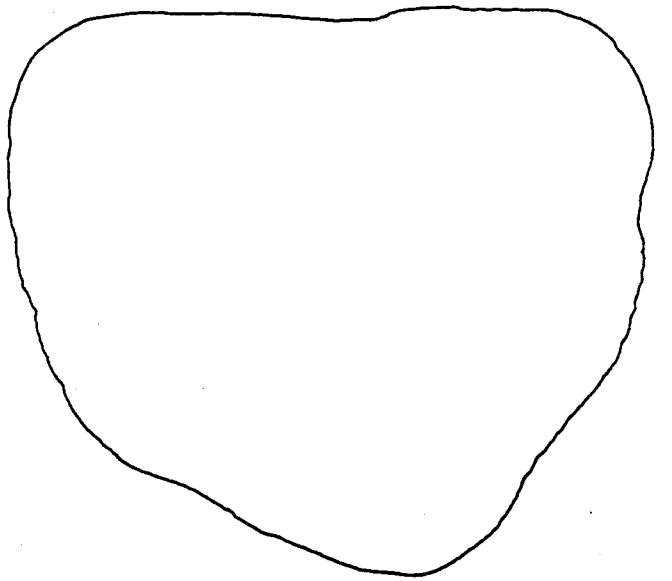
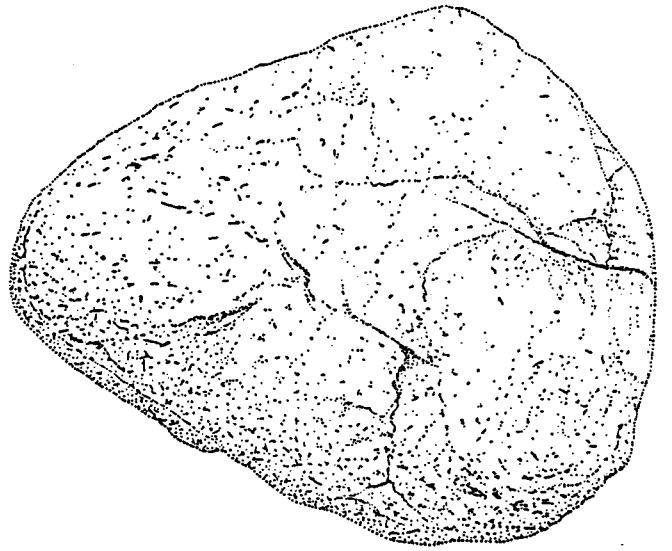
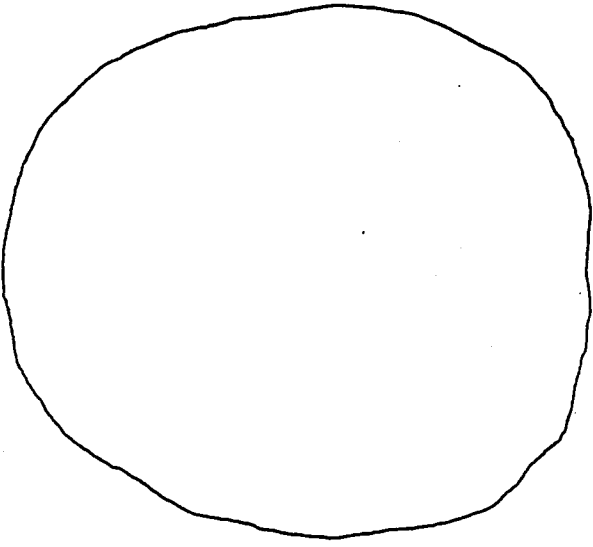

MC4

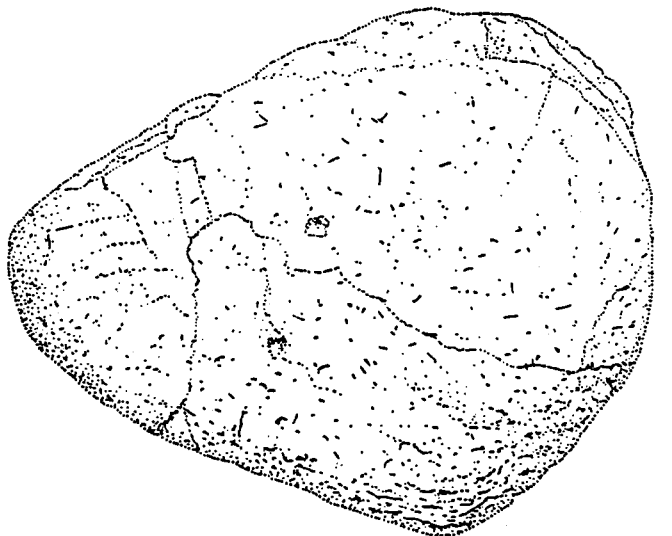

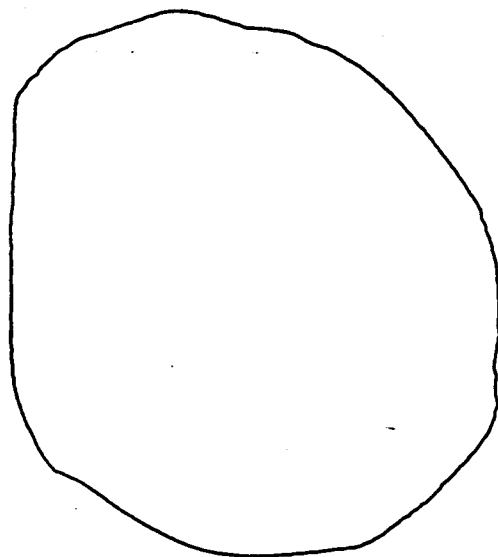
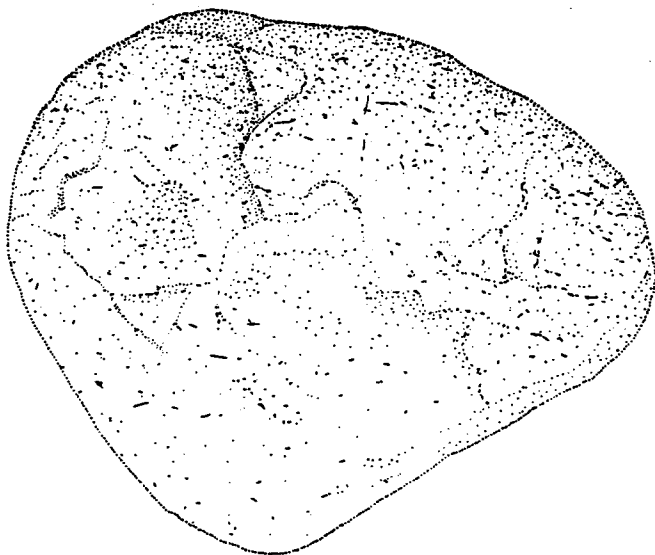
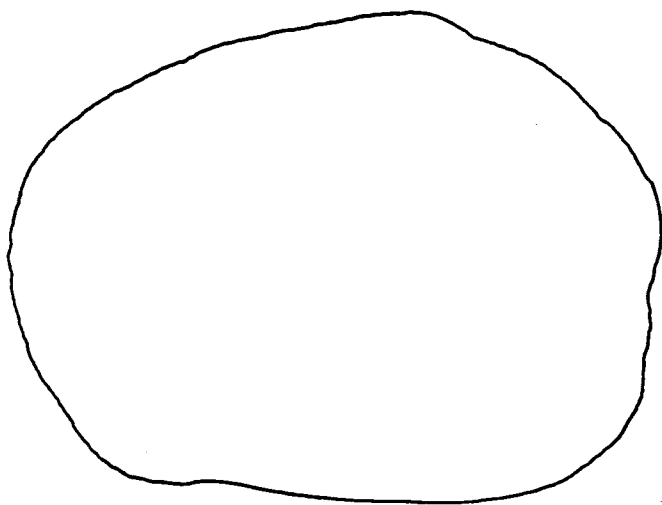
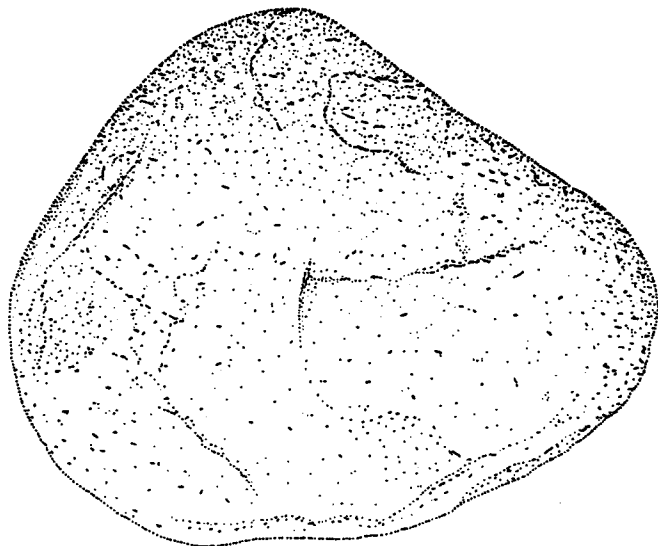

MC5





ANTA  
da  
**FONTE DA PIPA**





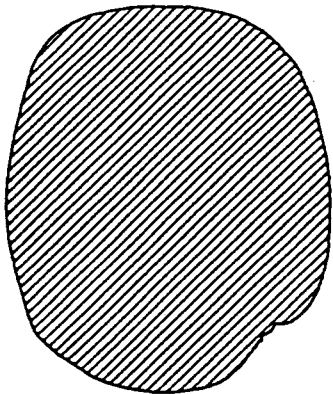
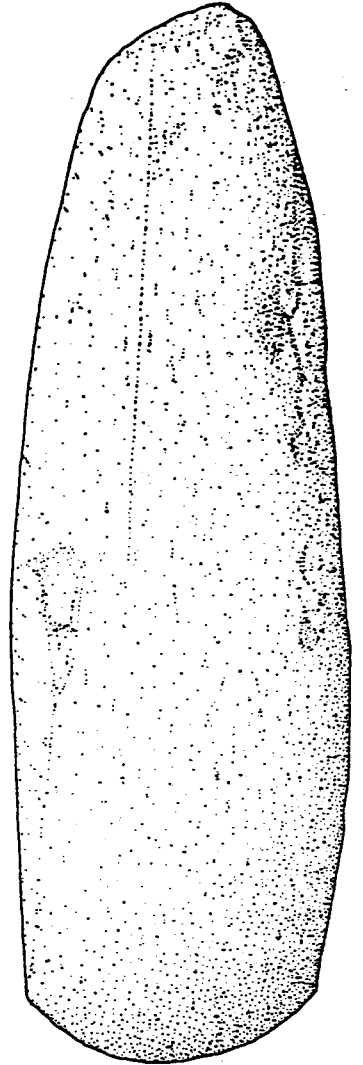
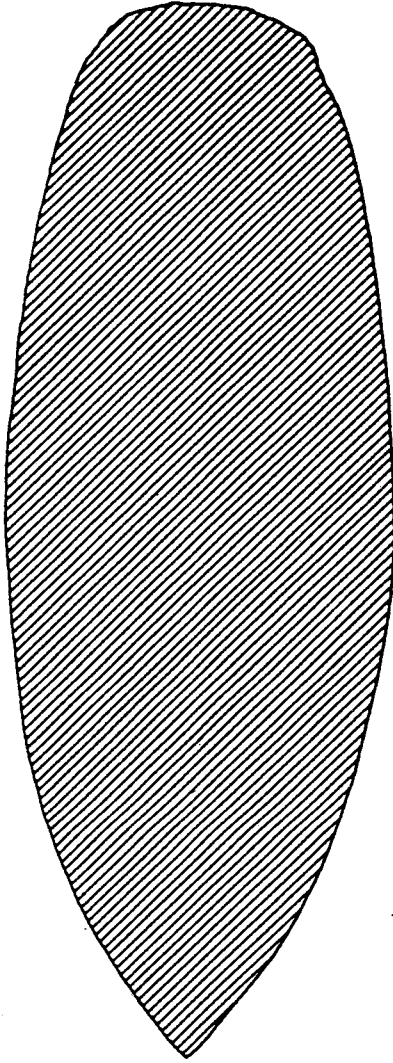
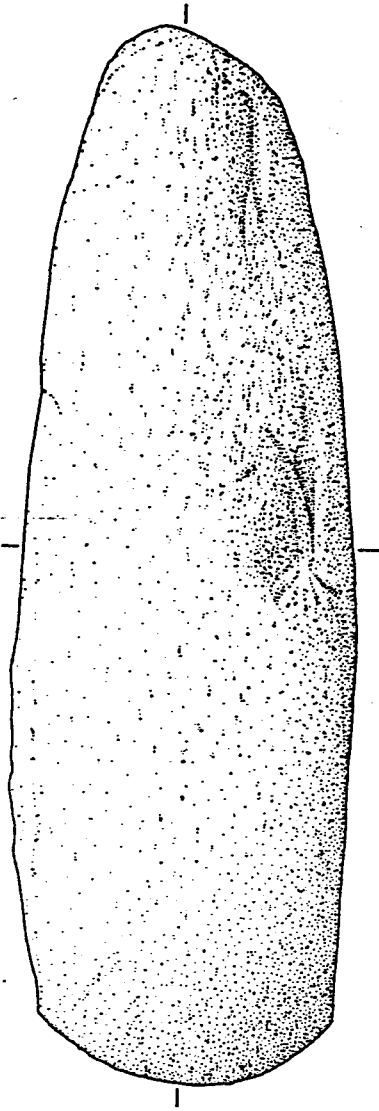

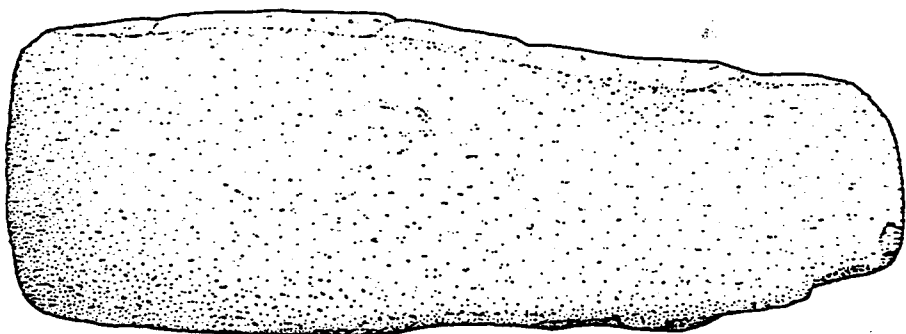
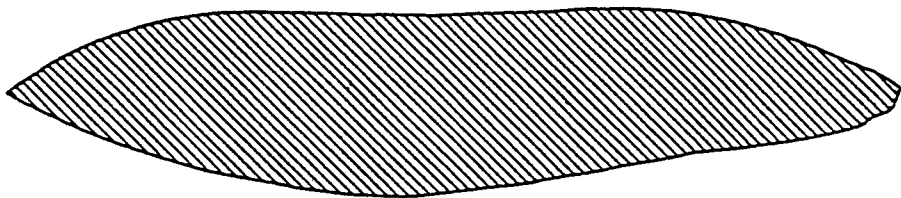
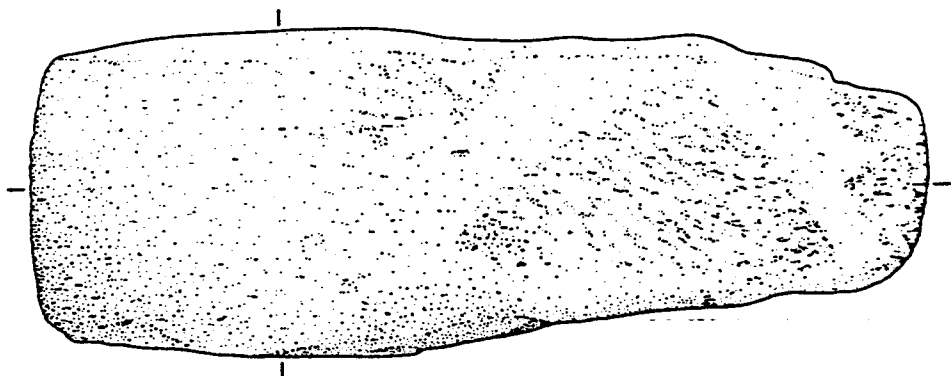
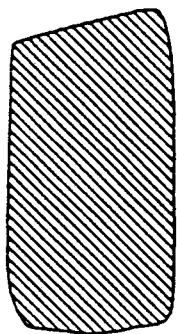

FP 17

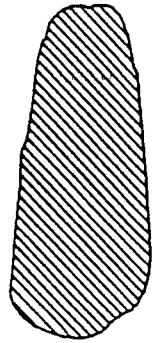
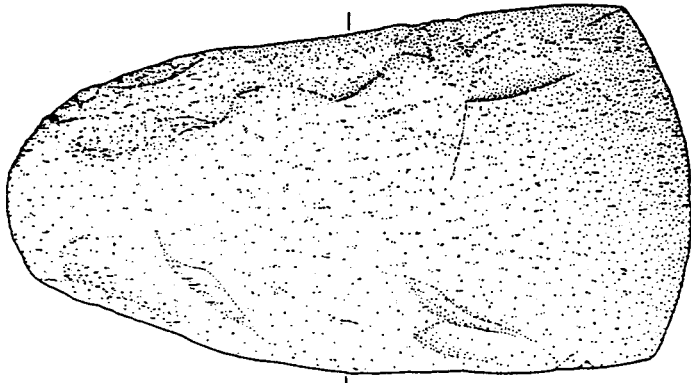
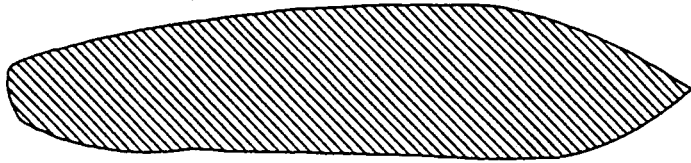
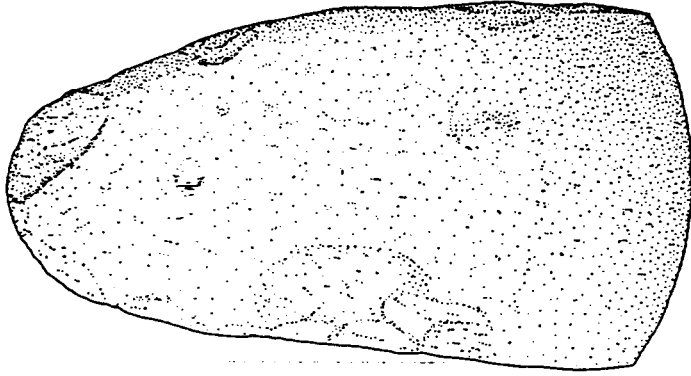

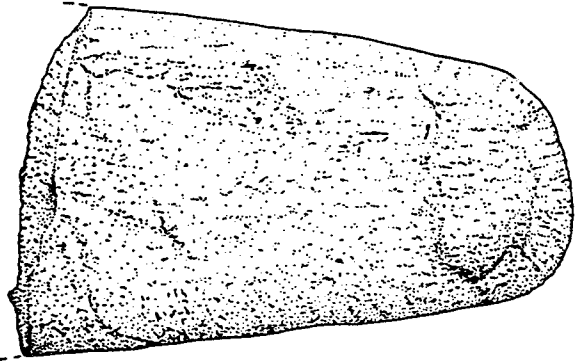
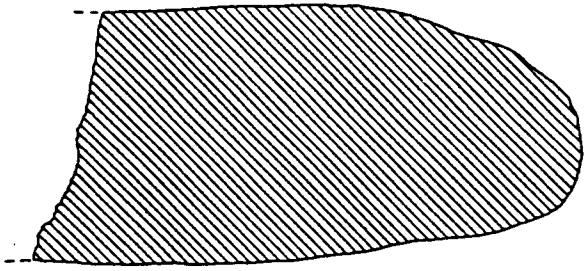
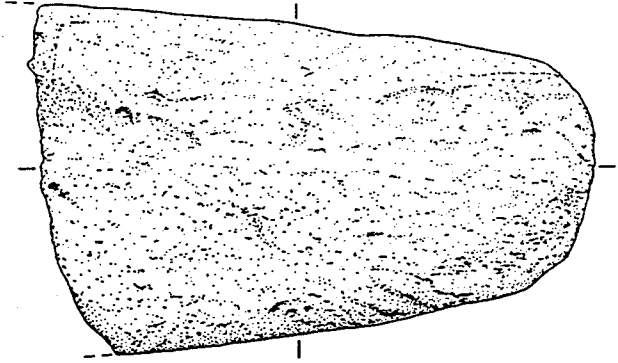
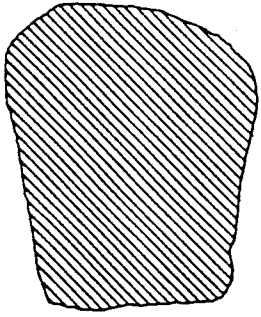

FP 15

FP 1

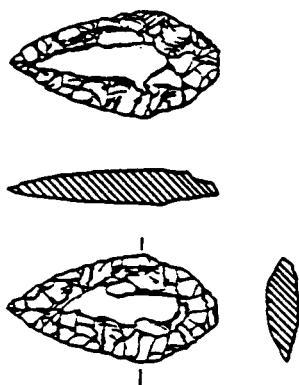

FP 7

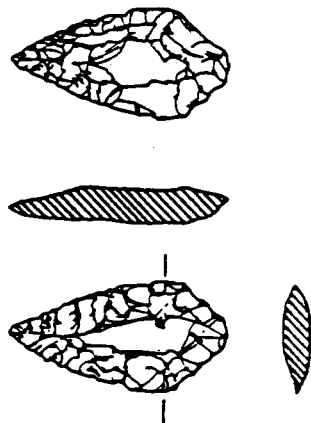

FP 5

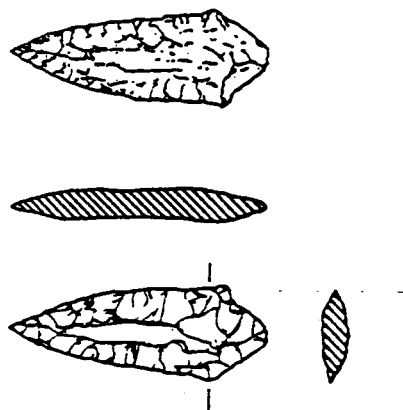

FP 3

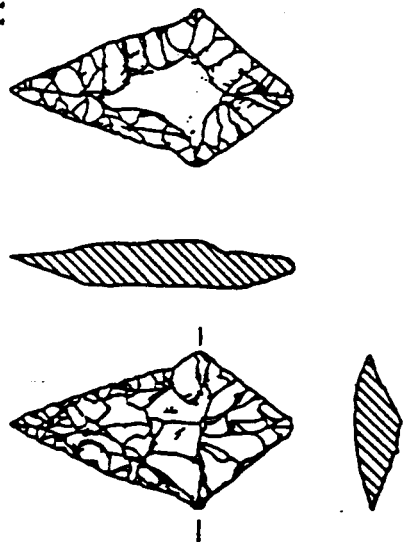

FP 6

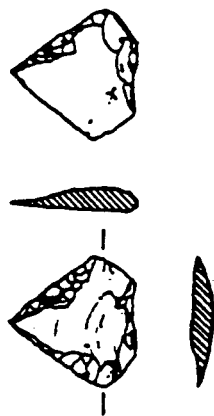

FP 2

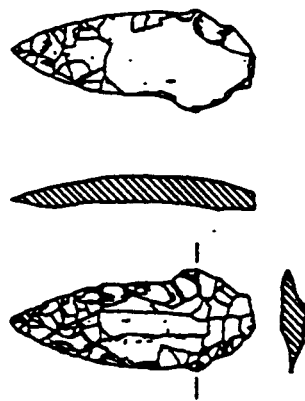

5 cm



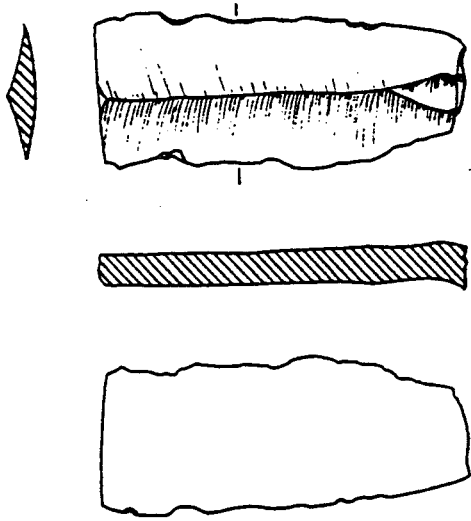

FP 10

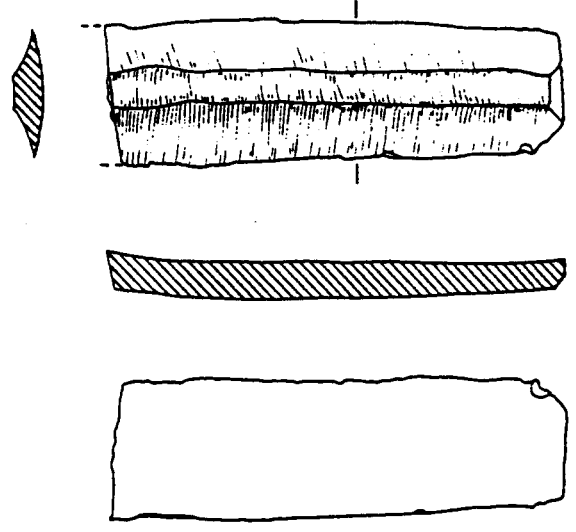

FP 9

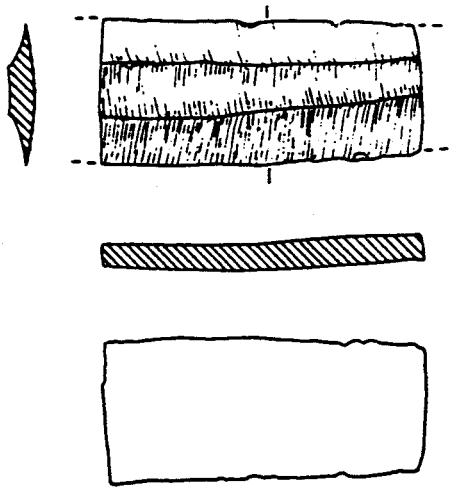

FP 8

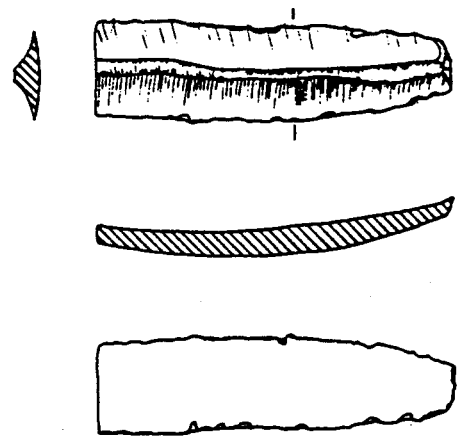

FP 11

FP 12

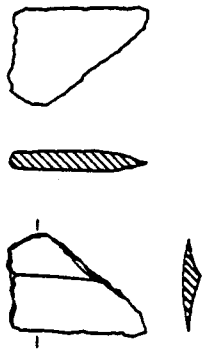

FP 13

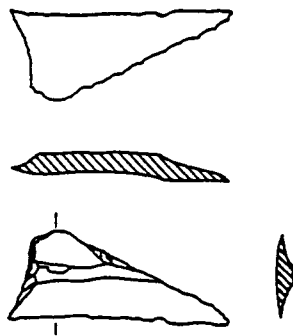

FP 14

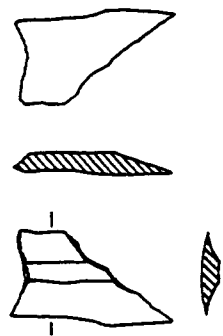



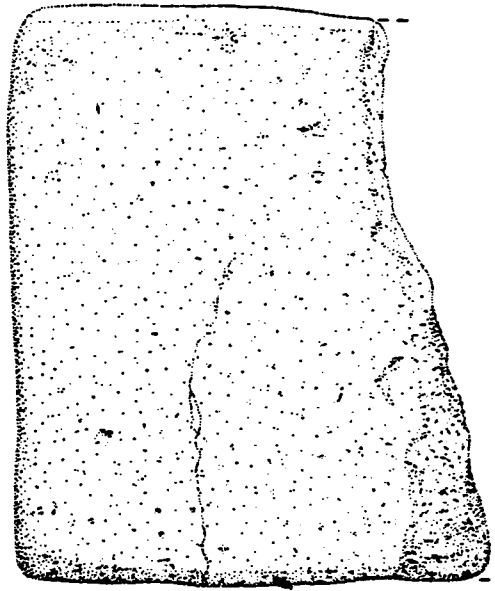
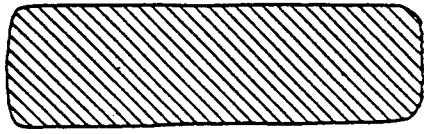
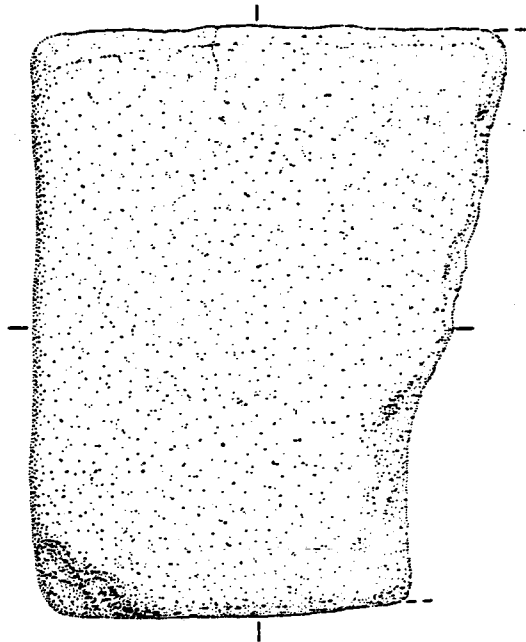
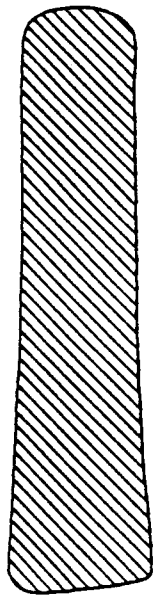

FP 21

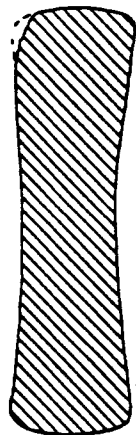
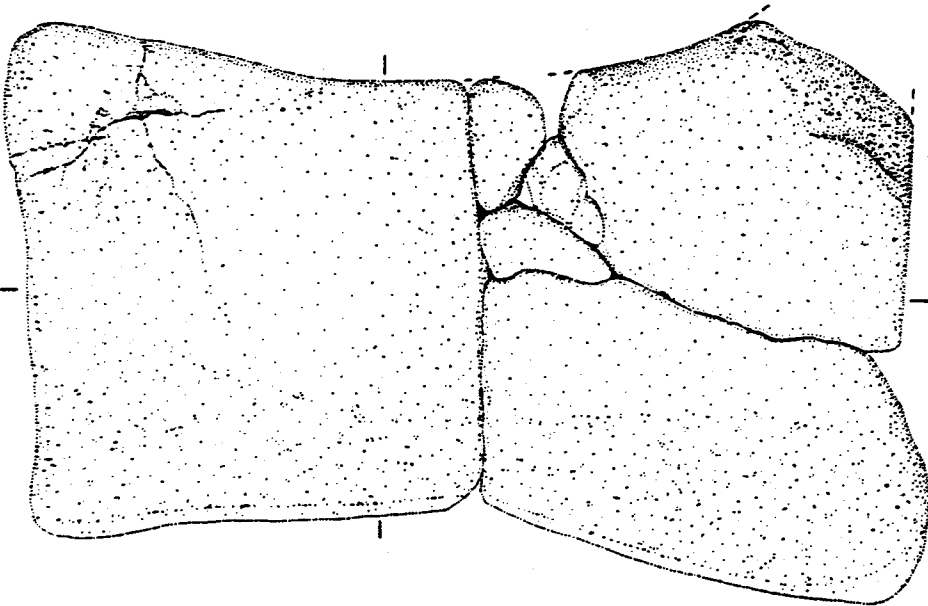
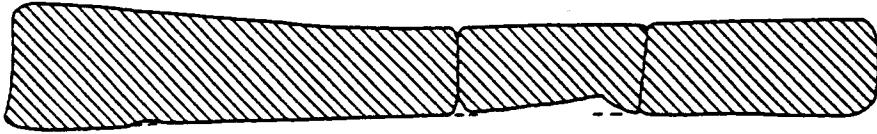
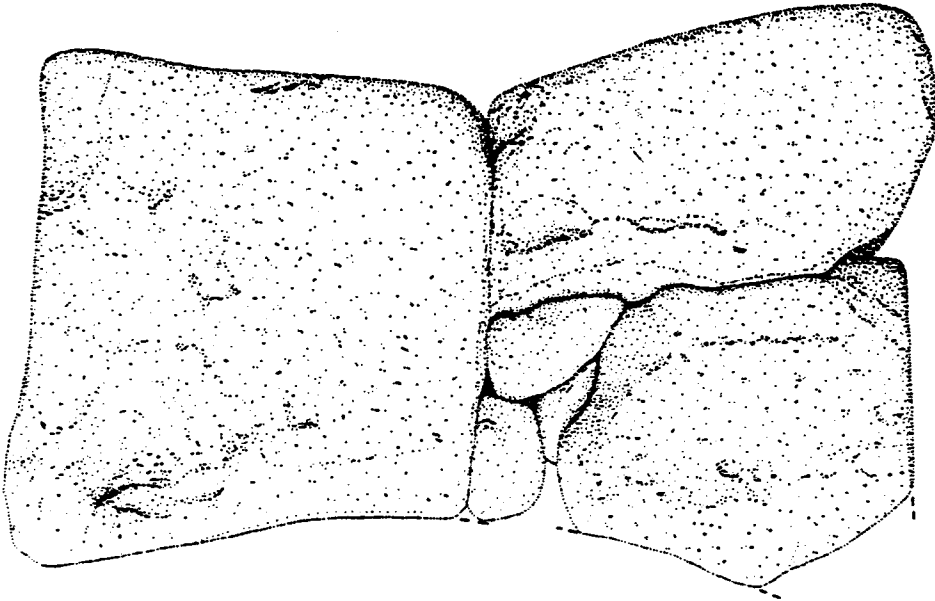

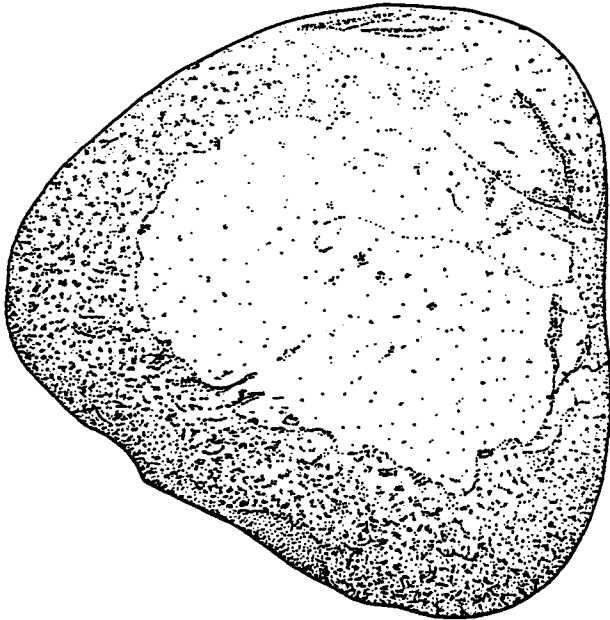
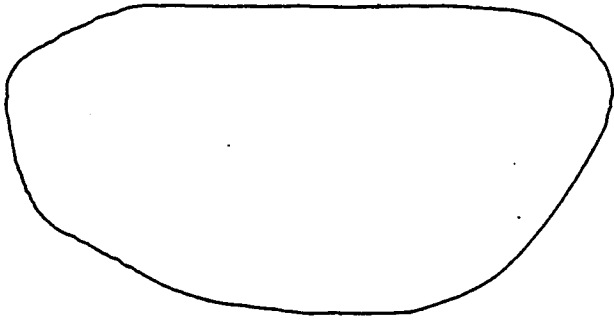
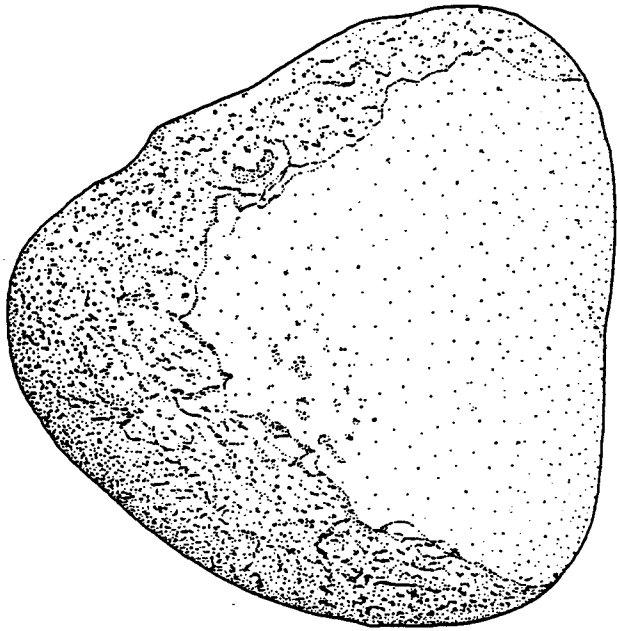

ANTA  
da  
**LOMBA DA BARCA**



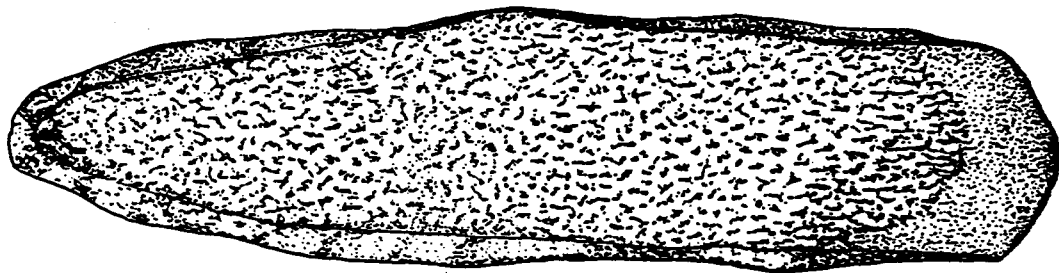

LB2

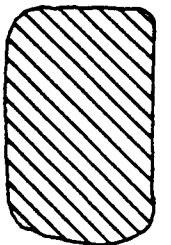
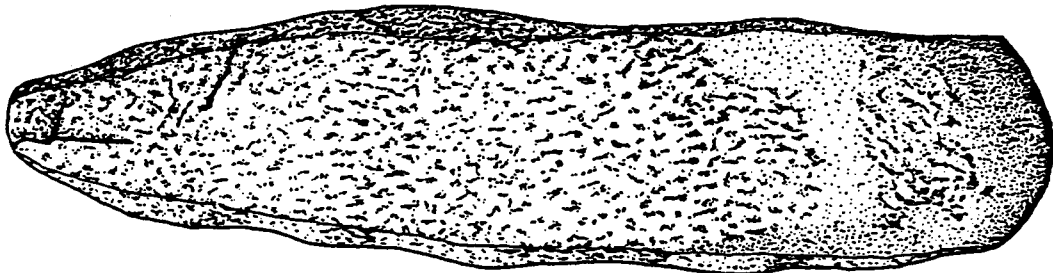
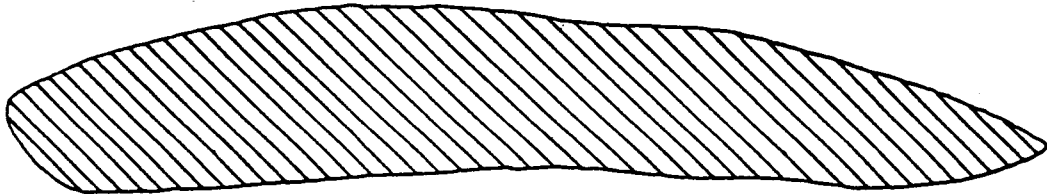

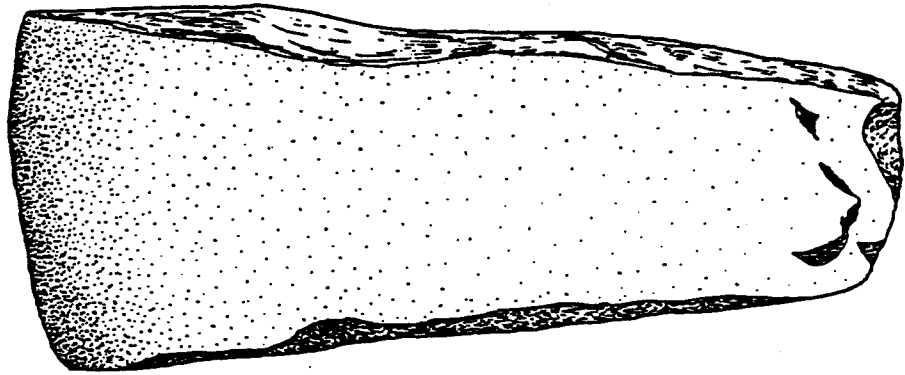
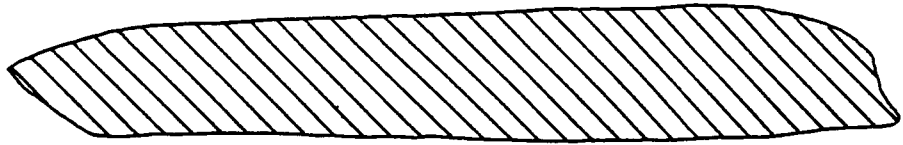
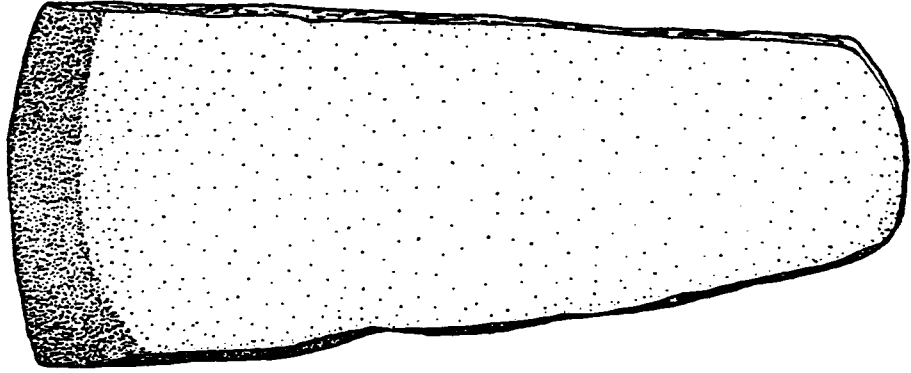
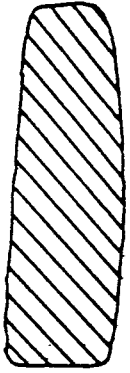

L/B1

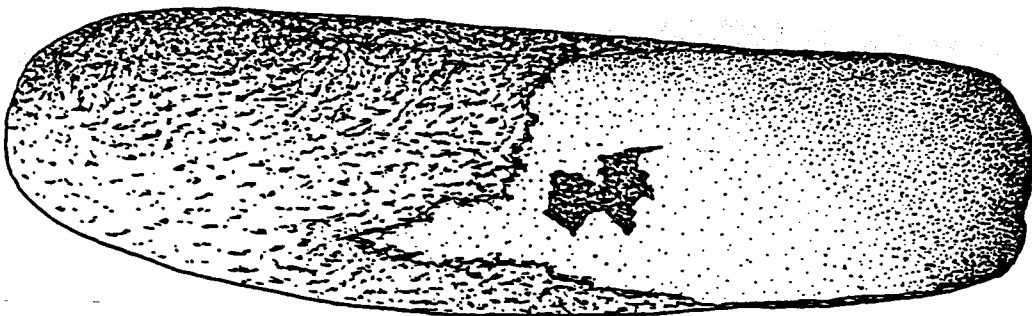
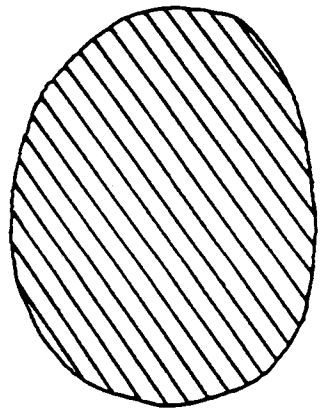
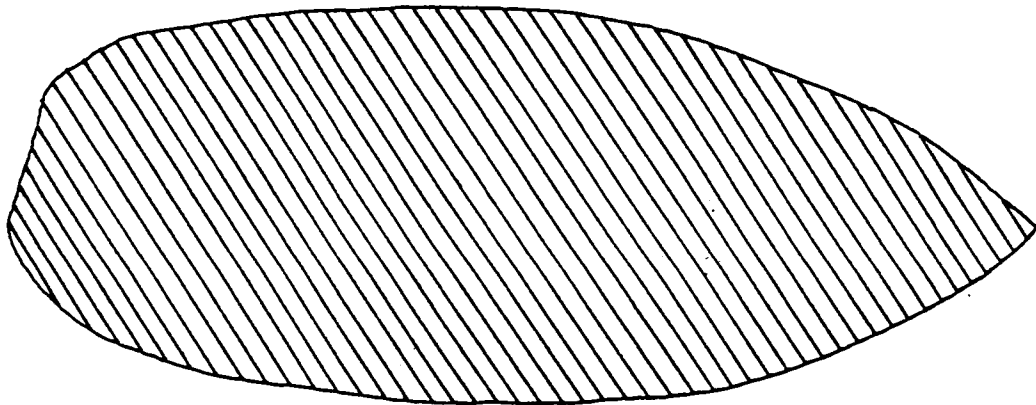
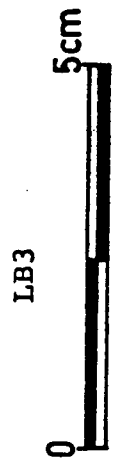
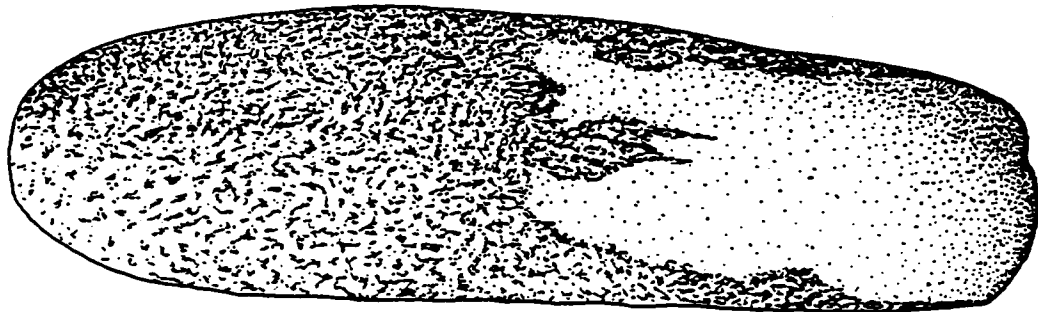



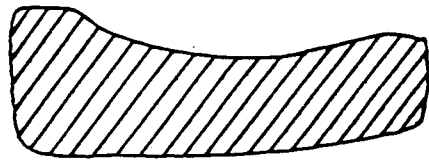
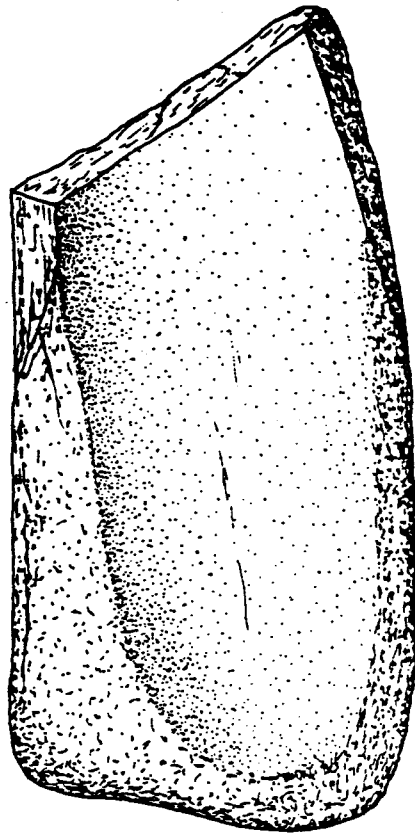

LB5

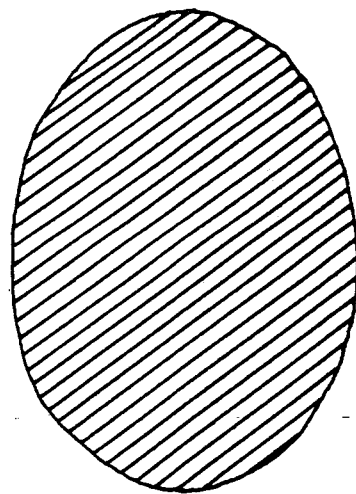
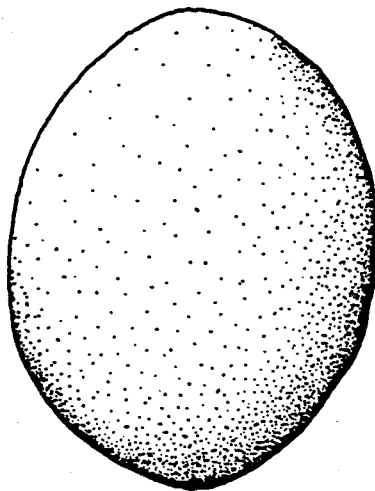

LB4



**ANTA**  
**da**  
**NAVE DO PADRE SANTO**



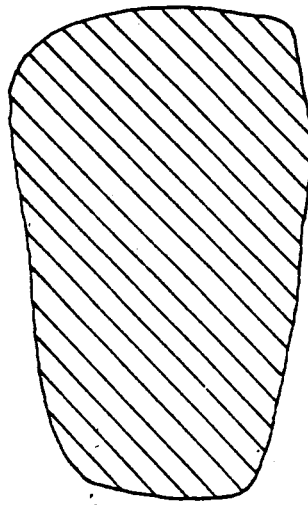
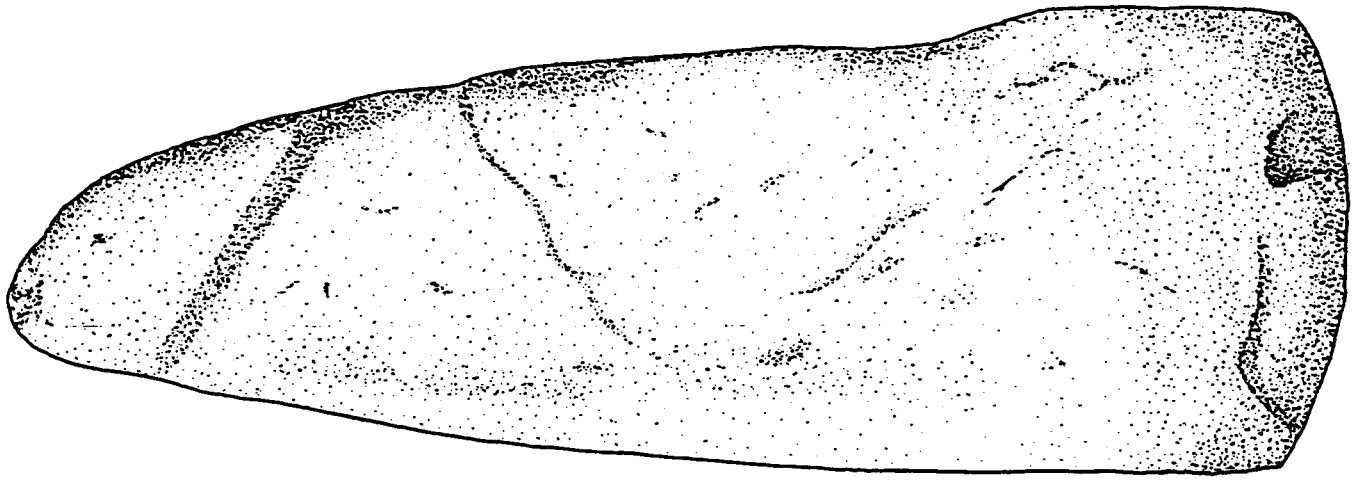

PS 2

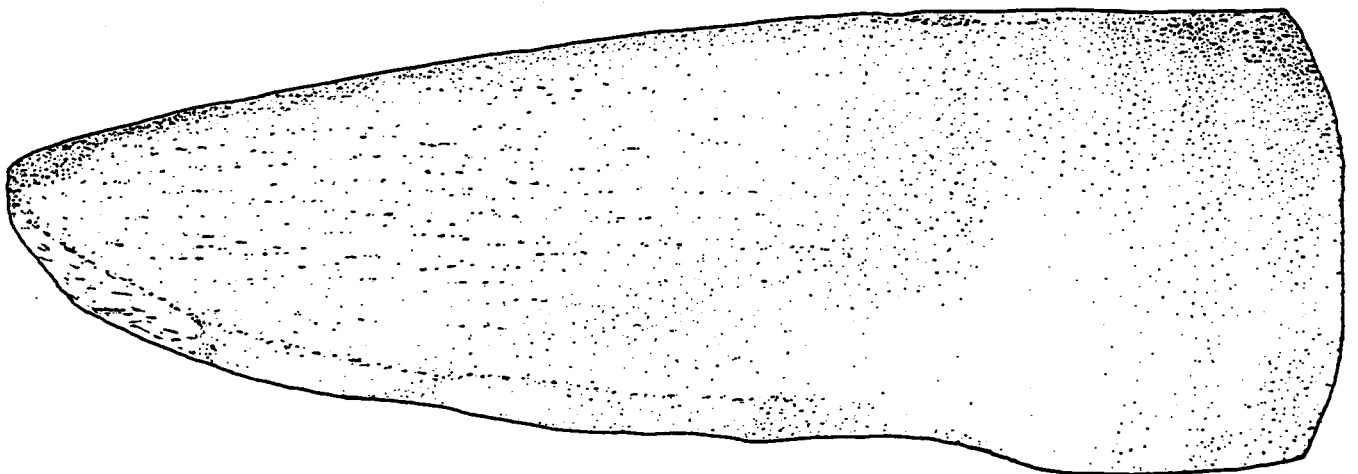
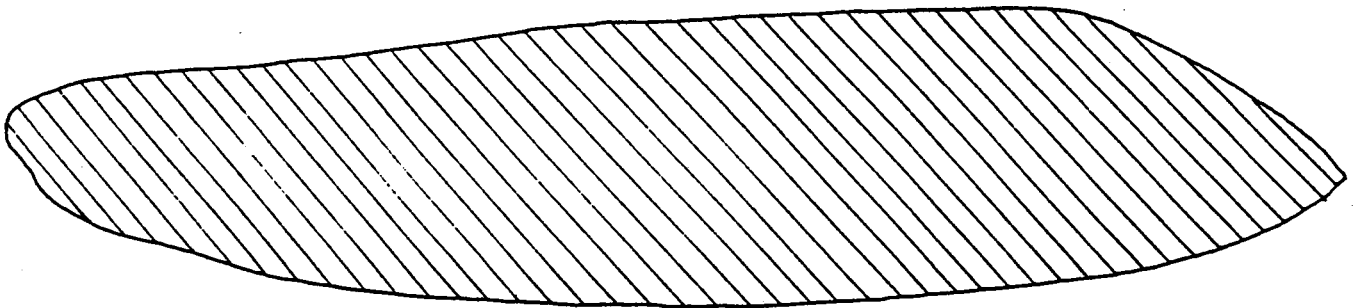

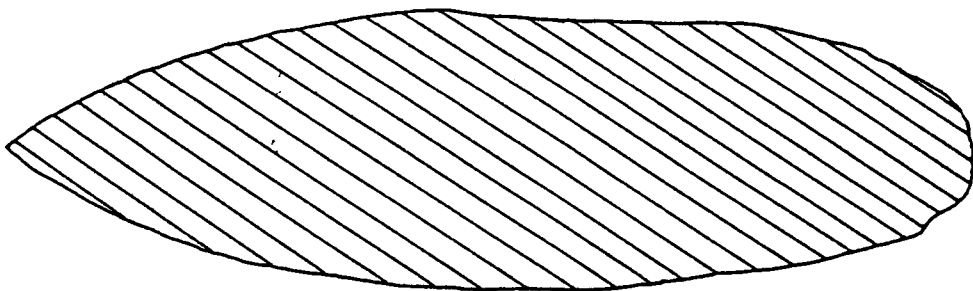
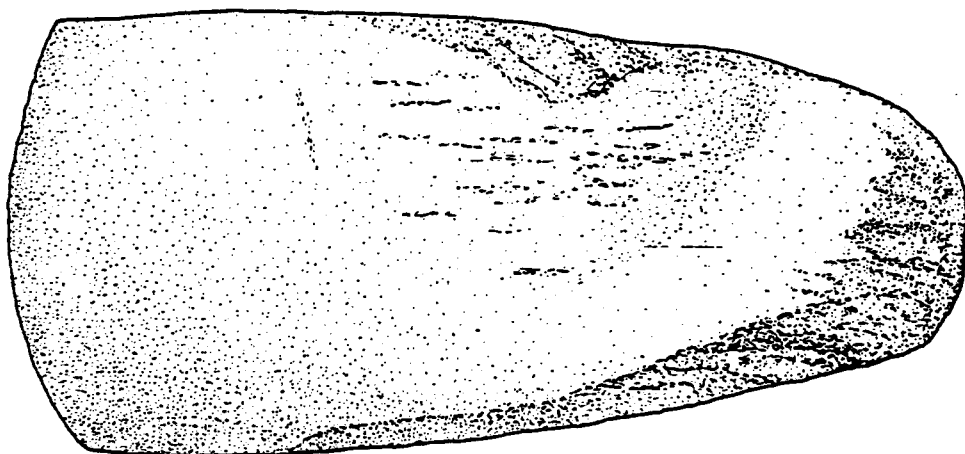
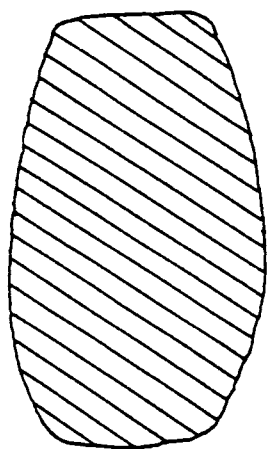

PS 1

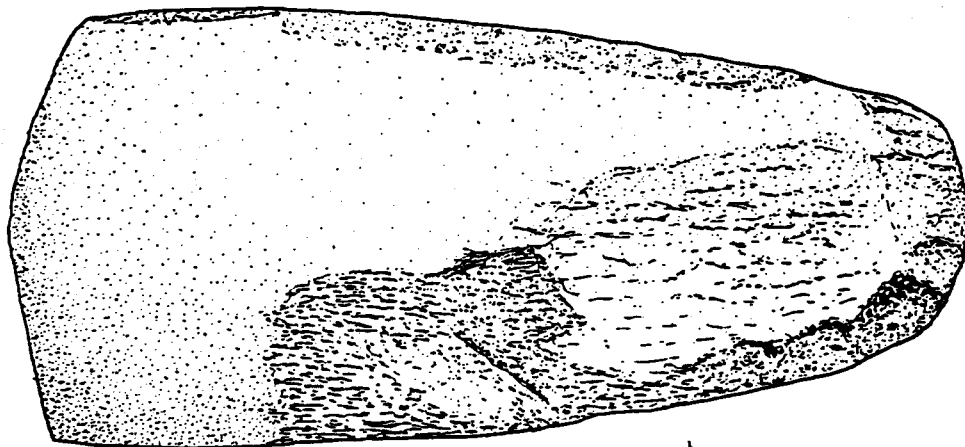

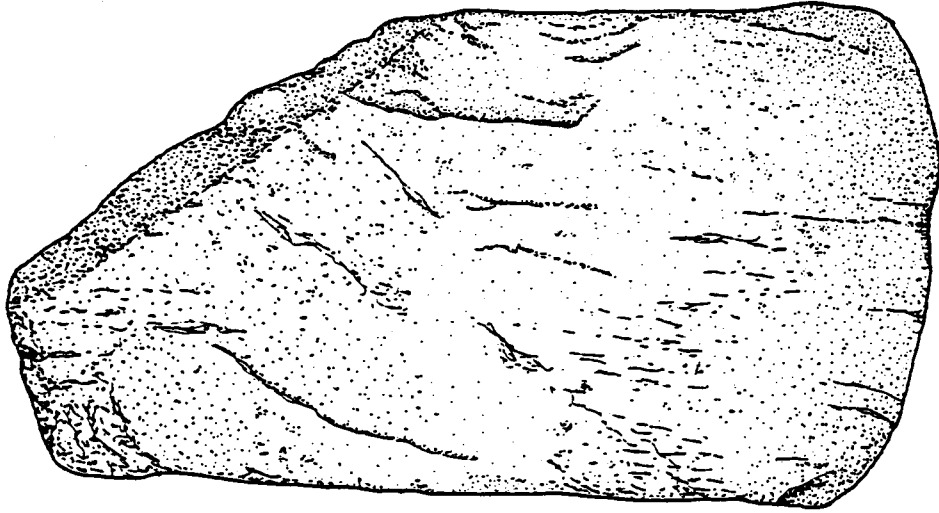

PS 3

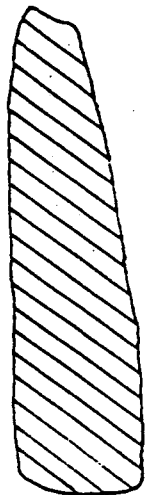
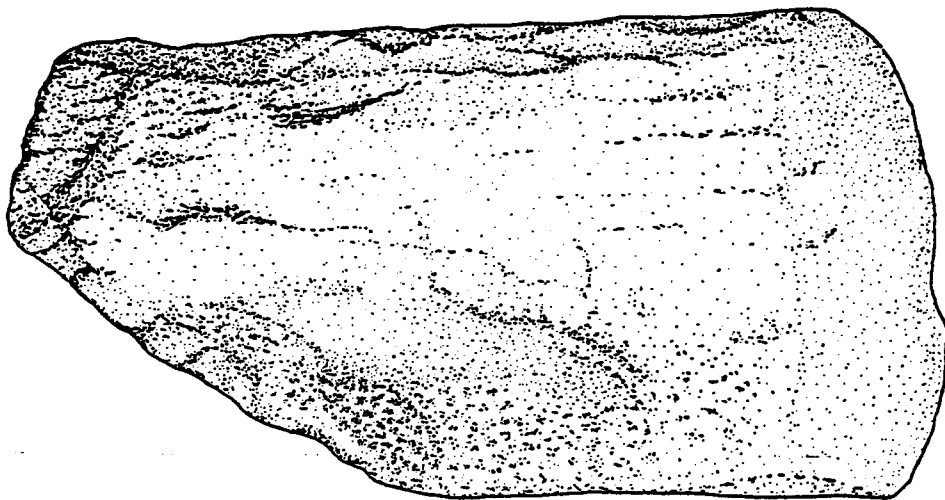
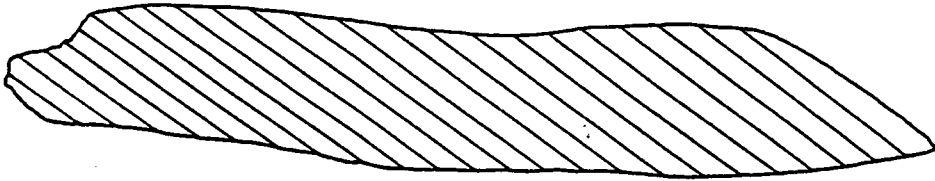

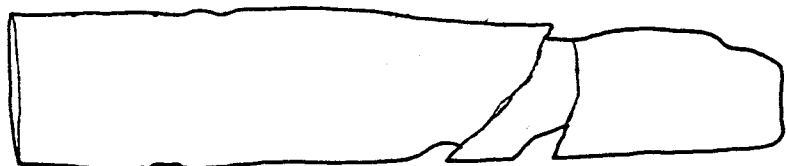
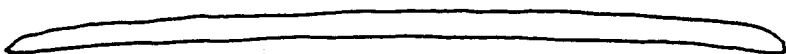
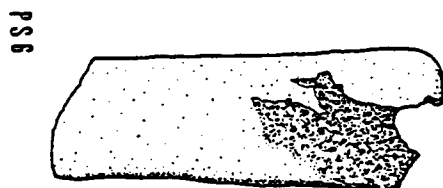
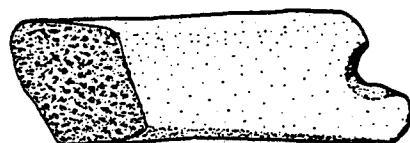
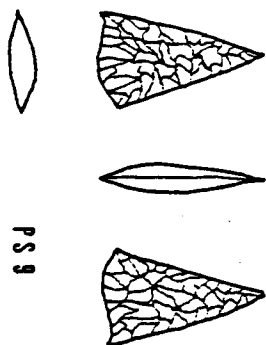
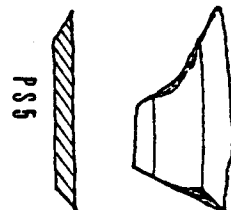
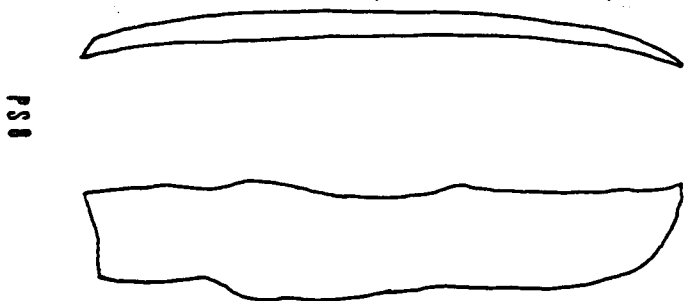
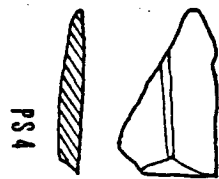

## DESCRIÇÃO DOS MATERIAIS





ANTA  
da  
**BOLA DA CERA**



NºBC13  
 OBJECTO-Conta de colar  
 MATERIAL-Xisto  
 QUADRADO-D4  
 X-  
 Y-  
 Z-98,56m  
 Crivo

NºBC14  
 OBJECTO-Elemento de colar  
 MATERIAL-Xisto  
 QUADRADO-D4  
 X-  
 Y-  
 Z-  
 Crivo

NºBC15  
 OBJECTO-Conta de colar  
 MATERIAL-Xisto  
 QUADRADO-D4  
 X-85cm  
 Y-95cm  
 Z-98,58m

NºBC16  
 OBJECTO-Conta de colar  
 MATERIAL-Xisto  
 QUADRADO-D4  
 X-29cm  
 Y-116cm  
 Z-98,72m

NºBC17  
 OBJECTO-Conta de colar  
 MATERIAL-Xisto  
 QUADRADO-D4  
 X-  
 Y-  
 Z-  
 Crivo

NºBC18  
 OBJECTO-Pendente  
 MATERIAL-Xisto  
 QUADRADO-E4  
 X-138cm  
 Y-114cm  
 Z-98,64m

NºBC19  
 OBJECTO-Ponta de seta  
 MATERIAL-Silex  
 QUADRADO-  
 X-  
 Y-  
 Z-  
 Crivo

NºBC20  
 OBJECTO-Conta de colar  
 MATERIAL-Xisto  
 QUADRADO-E4  
 X-  
 Y-  
 Z-98,57m

NºBC21  
 OBJECTO-Taça carenada  
 MATERIAL-Cerâmica  
 QUADRADO-D3  
 X-177cm  
 Y-055cm  
 Z-99,00m

NºBC22  
 OBJECTO-Taça  
 MATERIAL-Cerâmica  
 QUADRADO-E4  
 X-135cm  
 Y-78cm  
 Z-99,65m

NºBC23  
 OBJECTO-Vaso carenado com asa  
 MATERIAL-Cerâmica  
 QUADRADO-D4  
 X-50cm  
 Y-100cm  
 Z-99,28cm

NºBC24  
 OBJECTO-Vaso carenado com asa  
 MATERIAL-Cerâmica  
 QUADRADO-D4  
 X-120cm  
 Y-90cm  
 Z-99,10m

N8BC25  
OBJECTO-Taça  
MATERIAL-Cerâmica  
QUADRADO-D4  
X-20cm  
Y-157cm  
Z-99,00m

N8BC26  
OBJECTO-Taça carenada  
MATERIAL-Cerâmica  
QUADRADO-F4  
X-25cm  
Y-149cm  
Z-38,06m

N8BC27  
OBJECTO-Ponta de seta  
MATERIAL-Silex  
QUADRADO-D4  
X-151cm  
Y-144cm  
Z-98,62m

N8BC28  
OBJECTO-Ponta de seta  
MATERIAL-Silex  
QUADRADO-F4  
X-177cm  
Y-124cm  
Z-78,02m

N8BC29  
OBJECTO-Ponta de seta  
MATERIAL-Quartzo filoniano  
QUADRADO-D4  
X-64cm  
Y-153cm  
Z-98,84m

N8BC30  
OBJECTO-Ponta de seta  
MATERIAL-Quartzo hialino  
QUADRADO-D4  
X-108cm  
Y-103cm  
Z-98,67m

N8BC33  
OBJECTO-Ponta de seta  
MATERIAL-Quartzo filoniano  
QUADRADO-D4  
X-132cm  
Y-102cm  
Z-98,62m

N8BC34  
OBJECTO-Ponta de seta  
MATERIAL-Quartzo filoniano  
QUADRADO-D4  
X-  
Y-  
Z-98,47m

N8BC35  
OBJECTO-Geométrico  
MATERIAL-Silex  
QUADRADO-D4  
X-133cm  
Y-144cm  
Z-38,47m

N8BC36  
OBJECTO-Ponta de seta  
MATERIAL-Silex  
QUADRADO-D4  
X-144cm  
Y-137cm  
Z-98,47m

N8BC37  
OBJECTO-Ponta de seta  
MATERIAL-Quartzo filoniano  
QUADRADO-F4  
X-80cm  
Y-100cm  
Z-99,07m

N8BC38  
OBJECTO-Ponta de seta  
MATERIAL-Silex  
QUADRADO-F4  
X-  
Y-  
Z-99,08m

N9BC39  
OBJECTO-Ponta de seta  
MATERIAL-Silex  
QUADRADO-D4  
X-188cm  
Y-23cm  
Z-98,73m

N9BC40  
OBJECTO-Ponta de seta  
MATERIAL-Quartzo filoniano  
QUADRADO-C4  
X-157cm  
Y-104cm  
Z-98,73m

N9BC41  
OBJECTO-Ponta de seta  
MATERIAL-Silex  
QUADRADO-E4  
X-80cm  
Y-148cm  
Z-98,77m

N9BC42  
OBJECTO-Ponta de seta  
MATERIAL-Silex  
QUADRADO-F4  
X-10cm  
Y-160cm  
Z-98,74m

N9EC43  
OBJECTO-Ponta de seta  
MATERIAL-Quartzo hialino  
QUADRADO-D4  
X-  
Y-  
Z-98,47m

N9BC44  
OBJECTO-Ponta de seta  
MATERIAL-Silex  
QUADRADO-D4  
X-  
Y-  
Z-  
Crivo

N9BC45  
OBJECTO-Ponta de seta  
MATERIAL-Silex  
QUADRADO-E4  
X-  
Y-  
Z-98,47m

N9BC46  
OBJECTO-Ponta de seta  
MATERIAL-Silex  
QUADRADO-D4  
X-  
Y-  
Z-  
Crivo

N9BC47  
OBJECTO-Ponta de seta  
MATERIAL-Quartzo hialino  
QUADRADO-D4  
X-110cm  
Y-40cm  
Z-98,68m

N9BC49  
OBJECTO-Ponta de seta  
MATERIAL-Silex  
QUADRADO-F4  
X-148cm  
Y-108cm  
Z-98,61m

N9BC50  
OBJECTO-Ponta de seta  
MATERIAL-Quartzo filoniano  
QUADRADO-E4  
X-94cm  
Y-152cm  
Z-98,62m

N9BC51  
OBJECTO-Ponta de seta  
MATERIAL-Silex  
QUADRADO-E4  
X-59cm  
Y-54cm  
Z-98,57m

N9BC52  
OBJECTO-Ponta de seta  
MATERIAL-Silex  
QUADRADO-F4  
X-11cm  
Y-131cm  
Z-98,58m

N9BC53  
OBJECTO-Ponta de seta  
MATERIAL-Quartzo filoniano  
QUADRADO-E4  
X-  
Y-  
Z-98,64m

N9BC54  
OBJECTO-Ponta de seta  
MATERIAL-Silex  
QUADRADO-E4  
X-121cm  
Y-110cm  
Z-98,62m

N9BC55  
OBJECTO-Ponta de seta  
MATERIAL-Quartzo filoniano  
QUADRADO-D4  
X-80cm  
Y-125cm  
Z-99,58m

N9BC56  
OBJECTO-Ponta de seta  
MATERIAL-Quartzo filoniano  
QUADRADO-E4  
X-79cm  
Y-161cm  
Z-98,41m

N9BC57  
OBJECTO-Ponta de seta  
MATERIAL-Silex  
QUADRADO-D4  
X-  
Y-  
Z-99,10m

N9BC58  
OBJECTO-Ponta de seta  
MATERIAL-Silex  
QUADRADO-E4  
X-99cm  
Y-142cm  
Z-98,62m

N9BC59  
OBJECTO-Ponta de seta  
MATERIAL-Silex  
QUADRADO-  
X-  
Y-  
Z-  
Crivo-Cámara

N9BC60  
OBJECTO-Ponta de seta  
MATERIAL-Silex  
QUADRADO-D3  
X-139cm  
Y-5cm  
Z-98,62m

N9BC61  
OBJECTO-Ponta de seta  
MATERIAL-Silex  
QUADRADO-D4  
X-104cm  
Y-131cm  
Z-98,67m

N9BC62  
OBJECTO-Ponta de seta  
MATERIAL-Quartzo filoniano  
QUADRADO-E4  
X-97cm  
Y-111cm  
Z-98,73m

N9BC63  
OBJECTO-Ponta de seta  
MATERIAL-Quartzo filoniano  
QUADRADO-E4  
X-  
Y-  
Z-99,57m

NºBC64  
 OBJECTO-Ponta de seta  
 MATERIAL-Sílex  
 QUADRADO-D4  
 X-  
 Y-  
 Z-98,98m

NºBC65  
 OBJECTO-Idolo-Placa  
 MATERIAL-Xisto  
 QUADRADO-F4  
 X-8cm  
 Y-80cm  
 Z-99,74m

NºBC68  
 OBJECTO-Fragmento de idolo-placa  
 MATERIAL-Xisto  
 QUADRADO-D4  
 X-29cm  
 Y-21cm  
 Z-98,94m

NºBC69  
 OBJECTO-Idolo-placa  
 MATERIAL-Xisto  
 QUADRADO-F4  
 X-20cm  
 Y-140cm  
 Z-98,76m

NºBC72  
 OBJECTO-Fragmento de idolo-placa  
 MATERIAL-Xisto  
 QUADRADO-D4  
 X-166cm  
 Y-34cm  
 Z-98,63m

NºBC74  
 OBJECTO-Fragmento de idolo-placa  
 MATERIAL-Xisto  
 QUADRADO-C4  
 X-110cm  
 Y-118cm  
 Z-98,69m

NºBC75  
 OBJECTO-Idolo-placa  
 MATERIAL-Xisto  
 QUADRADO-E4  
 X-200cm  
 Y-150cm  
 Z-98,80m

NºBC77  
 OBJECTO-Fragmento de idolo-placa  
 MATERIAL-Xisto  
 QUADRADO-E4  
 X-165cm  
 Y-156cm  
 Z-98,64m

NºBC79  
 OBJECTO-Idolo-placa  
 MATERIAL-Xisto  
 QUADRADO-C4  
 X-170cm  
 Y-170cm  
 Z-99,00m

NºBC80  
 OBJECTO-Fragmento de idolo-placa  
 MATERIAL-Xisto  
 QUADRADO-D5  
 X-182cm  
 Y-193cm  
 Z-99,02m

NºBC82  
 OBJECTO-Fragmento de vaso semi-esférico  
 MATERIAL-Cerâmica  
 QUADRADO-E4  
 X-149cm  
 Y-105cm  
 Z-98,64m

NºBC84  
 OBJECTO-Taça  
 MATERIAL-Cerâmica  
 QUADRADO-F4  
 X-0cm  
 Y-88cm  
 Z-98,74



NOBC86  
OBJETO-Fragmento de idolo-placa  
MATERIAL-Gres  
QUADRADO-D4  
X-174cm  
Y-50cm  
Z-98,67m

NOBC87  
OBJETO-Fragmento de lamina  
MATERIAL-Silex  
QUADRADO-E4  
X-33cm  
Y-85cm  
Z-99,67m

NOBC88  
OBJETO-Fragmento de lamina  
MATERIAL-Silex  
QUADRADO-D4  
X-15cm  
Y-200cm  
Z-98,59m

NOBC89  
OBJETO-Machado  
MATERIAL-Amfibolite  
QUADRADO-G4  
X-120cm  
Y-60cm  
Z-98,55m

NOBC90  
OBJETO-Crescente  
MATERIAL-Xisto  
QUADRADO-D4  
X-35cm  
Y-148cm  
Z-99,00m

NOBC93  
OBJETO-Taca  
MATERIAL-Cerâmica  
QUADRADO-E4  
X-123cm  
Y-118cm  
Z-98,47m

NOBC95  
OBJETO-Taca  
MATERIAL-Cerâmica  
QUADRADO-D4  
X-47cm  
Y-165cm  
Z-99,02m

NOBC96  
OBJETO-Vaso  
MATERIAL-Cerâmica  
QUADRADO-D4  
X-101cm  
Y-140cm  
Z-99,10m

NOBC97  
OBJETO-Fragmento de taca  
MATERIAL-Cerâmica  
QUADRADO-D4  
X-112cm  
Y-64cm  
Z-98,72m

NOBC98  
OBJETO-Fragmento de taca carenada  
MATERIAL-Cerâmica  
QUADRADO-E4  
X-20cm  
Y-100cm  
Z-98,74m

NOBC99  
OBJETO-fragmento de taca  
MATERIAL-Cerâmica  
QUADRADO-E4  
X-30cm  
Y-127cm  
Z-98,67m

NOBC100  
OBJETO-Fragmento de vaso semi-esférico  
MATERIAL-Cerâmica  
QUADRADO-F4  
X-9cm  
Y-24cm  
Z-98,69m

N98C102  
OBJECTO-Fragmento de taça  
MATERIAL-Cerâmica  
QUADRADO-C4  
X-  
Y-  
Z-  
Crivo

N98C104  
OBJECTO-Fragmento de taça  
MATERIAL-Cerâmica  
QUADRADO-D4  
X-131cm  
Y-145cm  
Z-98,68m

N98C105  
OBJECTO-Fragmento de taça(?)  
MATERIAL-Cerâmica  
QUADRADO-D4  
X-90cm  
Y-130cm  
Z-99,18m

N98C106  
OBJECTO-Fragmento de taça  
MATERIAL-Cerâmica  
QUADRADO-E4  
X-46cm  
Y-16cm  
Z-98,67m

N98C107  
OBJECTO-Fragmento de taça  
MATERIAL-Cerâmica  
QUADRADO-C4  
X-178cm  
Y-70cm  
Z-98,68m

N98C109  
OBJECTO-Fragmento de taça  
MATERIAL-Cerâmica  
QUADRADO-F4  
X-3cm  
Y-114cm  
Z-98,05m

N98C112  
OBJECTO-Fragmento de taça  
MATERIAL-Cerâmica  
QUADRADO-F4  
X-13cm  
Y-77cm  
Z-98,84m

N98C113  
OBJECTO-Fragmento de taça  
MATERIAL-Cerâmica  
QUADRADO-D4  
X-53cm  
Y-186cm  
Z-99,19m

N98C114  
OBJECTO-Fragmento de taça  
MATERIAL-Cerâmica  
QUADRADO-D4  
X-30cm  
Y-84cm  
Z-98,62m

N98C118  
OBJECTO-Fragmento de taça (?) carenada  
MATERIAL-Cerâmica  
QUADRADO-D4  
X-178cm  
Y-120cm  
Z-98,63m

N98C120  
OBJECTO-Fragmento de taça (?)  
MATERIAL-Cerâmica  
QUADRADO-E4  
X-130cm  
Y-75cm  
Z-98,64m

N98C121  
OBJECTO-Fragmento de taça(?)  
MATERIAL-Cerâmica  
QUADRADO-D4  
X-41cm  
Y-152cm  
Z-98,78m

N9BC122  
OBJECTO-Fragmento de vaso semi-esférico  
MATERIAL-Cerâmica  
QUADRADO-F4  
X-32cm  
Y-150cm  
Z-99,74m

N9BC124  
OBJECTO-Fragmento de taça carenada com mamilos  
MATERIAL-Cerâmica  
QUADRADO-D4  
X-115cm  
Y-29cm  
Z-99,28m

N9BC127  
OBJECTO-Fragmento de prato  
MATERIAL-Cerâmica  
QUADRADO-E4  
X-32cm  
Y-83cm  
Z-99,09m

N9BC128  
OBJECTO-Fragmento de taça carenada  
MATERIAL-Cerâmica  
QUADRADO-D4  
X-20cm  
Y-123cm  
Z-99,28m

N9BC129  
OBJECTO-Fragmento de taça  
MATERIAL-Cerâmica  
QUADRADO-E4  
X-130cm  
Y-145cm  
Z-98,57m

N9BC129 A  
OBJECTO-Fragmento de taça carenada (?)  
MATERIAL-Cerâmica  
QUADRADO-E4  
X-130cm  
Y-145cm  
Z-98,57m

N9BC130  
OBJECTO-Fragmento de taça carenada  
MATERIAL-Cerâmica  
QUADRADO-D4  
X-190cm  
Y-168cm  
Z-98,67m

N9BC133  
OBJECTO-Fragmento de taça carenada  
MATERIAL-Cerâmica  
QUADRADO-C4  
X-179cm  
Y-15cm  
Z-98,69m

N9BC134  
OBJECTO-Fragmento de vaso esférico  
MATERIAL-Cerâmica  
QUADRADO-E4  
X-  
Y-  
Z-  
Crivo

N9BC135  
OBJECTO-Fragmento de vaso semi-esférico  
MATERIAL-Cerâmica  
QUADRADO-D4  
X-  
Y-  
Z-  
Superfície

N9BC142  
OBJECTO-Fragmento de vaso semi-esférico  
MATERIAL-Cerâmica  
QUADRADO-E4  
X-90cm  
Y-123cm  
Z-98,52m

N9BC151  
OBJECTO-Fragmento de lâmina  
MATERIAL-Sílex  
QUADRADO-F4  
X-129cm  
Y-98cm  
Z-99,63m

NºBC154  
OBJECTO-Fragmento de lámina  
MATERIAL-Sílex  
QUADRADO-D4  
X-123cm  
Y-121cm  
Z-98,62m

NºBC159  
OBJECTO-Lámina  
MATERIAL-Sílex  
QUADRADO-D4  
X-7cm  
Y-119cm  
Z-98,67m

NºBC160  
OBJECTO-Fragmento de lámina  
MATERIAL-Sílex  
QUADRADO-E4  
X-132cm  
Y-144cm  
Z-78,39m

NºBC162  
OBJECTO-Machado reaproveitado  
MATERIAL-Anfibolite  
QUADRADO-C4  
X-62cm  
Y-146cm  
Z-98,81m

NºBC163  
OBJECTO-Lámina-buril  
MATERIAL-Xist jaspoide  
QUADRADO-D4  
X-  
Y-  
Z-98,98m

NºBC170  
OBJECTO-Machado  
MATERIAL-Anfibolite  
QUADRADO-D4  
X-83cm  
Y-157cm  
Z-98,33m

NºBC174  
OBJECTO-Buril  
MATERIAL-Sílex  
QUADRADO-G4  
X-146cm  
Y-81cm  
Z-98,55m

NºBC176  
OBJECTO-Fragmento de lámina  
MATERIAL-Sílex  
QUADRADO-F4  
X-52cm  
Y-90cm  
Z-98,64m

NºBC177  
OBJECTO-Fragmento de lámina  
MATERIAL-Sílex  
QUADRADO-C4  
X-130cm  
Y-63cm  
Z-98,47m

NºBC179  
OBJECTO-Idolo-placa  
MATERIAL-Xisto  
QUADRADO-D5  
X-118cm  
Y-20cm  
Z-98,47m

NºBC180  
OBJECTO-Conta de colar  
MATERIAL-Xisto  
QUADRADO-E5  
X-  
Y-  
Z-98,41m

NºBC181  
OBJECTO-Conta de colar  
MATERIAL-Xisto  
QUADRADO-D5  
X-87cm  
Y-191cm  
Z-98,91m

N9BC182  
OBJECTO-Conta de colar  
MATERIAL-Xisto  
QUADRADO-D5  
X-  
Y-  
Z-98,56m

N9BC183  
OBJECTO-Conta de colar  
MATERIAL-Xisto  
QUADRADO-D5  
X-107cm  
Y-110cm  
Z-98,88m

N9BC184  
OBJECTO-Conta de colar  
MATERIAL-Xisto  
QUADRADO-D5  
X-  
Y-  
Z-98,51

N9BC185  
OBJECTO-Conta de colar  
MATERIAL-Xisto  
QUADRADO-D5  
X-  
Y-  
Z-98,40m

N9BC186  
OBJECTO-Conta de colar  
MATERIAL-Xisto  
QUADRADO-D5  
X-87cm  
Y-71cm  
Z-98,91m

N9BC187  
OBJECTO-Conta de colar  
MATERIAL-Xisto  
QUADRADO-D5  
X-  
Y-  
Z-98,75m

N9BC188  
OBJECTO-Conta de colar  
MATERIAL-Xisto  
QUADRADO-D5  
X-  
Y-  
Z-98,46m

N9BC189  
OBJECTO-Conta de colar  
MATERIAL-Xisto  
QUADRADO-D5  
X-68cm  
Y-92cm  
Z-98,45m

N9BC190  
OBJECTO-Conta de colar  
MATERIAL-Xisto  
QUADRADO-D5  
X-68cm  
Y-82cm  
Z-98,45m

N9BC191  
OBJECTO-Conta de colar  
MATERIAL-Xisto  
QUADRADO-D5  
X-68cm  
Y-82cm  
Z-98,45m

N9BC192  
OBJECTO-Conta de colar  
MATERIAL-Xisto  
QUADRADO-D5  
X-113cm  
Y-75cm  
Z-98,51m

N9BC192 A  
OBJECTO-Conta de colar  
MATERIAL-Xisto  
QUADRADO-D5  
X-113cm  
Y-75cm  
Z-98,51m

NøBC192 B  
OBJECTO-Conta de colar  
MATERIAL-Xisto  
QUADRADO-D5  
X-113cm  
Y-75cm  
Z-98,51m

NøBC192 C  
OBJECTO-Conta de colar  
MATERIAL-Xisto  
QUADRADO-D5  
X-113cm  
Y-75cm  
Z-98,51m

NøBC193  
OBJECTO-Conta de colar  
MATERIAL-Xisto  
QUADRADO-D5  
X-132cm  
Y-30cm  
Z-98,52m

NøBC194  
OBJECTO-Conta de colar  
MATERIAL-Xisto  
QUADRADO-D5  
X-128cm  
Y-117cm  
Z-98,51m

NøBC195  
OBJECTO-Conta de colar  
MATERIAL-Arenito  
QUADRADO-D5  
X-  
Y-  
Z-98,98m

NøBC196  
OBJECTO-Conta de colar  
MATERIAL-Xisto  
QUADRADO-D5  
X-  
Y-  
Z-98,51m

NøBC196 A  
OBJECTO-Conta de colar  
MATERIAL-Xisto  
QUADRADO-D5  
X-  
Y-  
Z-98,51m

NøBC197  
OBJECTO-Conta de colar  
MATERIAL-Xisto  
QUADRADO-D5  
X-  
Y-  
Z-98,40m

NøBC199  
OBJECTO-Conta de colar  
MATERIAL-Xisto  
QUADRADO-D5  
X-  
Y-  
Z-98,40m

NøBC199  
OBJECTO-Conta de colar  
MATERIAL-D5  
QUADRADO-  
X-  
Y-  
Z-98,40m

NøBC200  
OBJECTO-Conta de colar  
MATERIAL-Xisto  
QUADRADO-D5  
X-68cm  
Y-82cm  
Z-98,45m

NøBC201  
OBJECTO-Conta de colar  
MATERIAL-Xisto  
QUADRADO-D5  
X-  
Y-  
Z-98,51m

NEBC202  
OBJECTO-Conta de colar  
MATERIAL-Xisto  
QUADRADO-D5  
X-104cm  
Y-64cm  
Z-98,51m

NEBC203  
OBJECTO-Conta de colar  
MATERIAL-Xisto  
QUADRADO-D5  
X-128cm  
Y-117cm  
Z-98,51m

NEBC203 A  
OBJECTO-Conta de colar  
MATERIAL-Xisto  
QUADRADO-D5  
X-128cm  
Y-117cm  
Z-98,51m

NEBC203 B  
OBJECTO-Conta de colar  
MATERIAL-Xisto  
QUADRADO-D5  
X-128cm  
Y-117cm  
Z-98,51m

NEBC203 C  
OBJECTO-Conta de colar  
MATERIAL-Xisto  
QUADRADO-D5  
X-128cm  
Y-117cm  
Z-98,51m

NEBC203 D  
OBJECTO-Conta de colar  
MATERIAL-Xisto  
QUADRADO-D5  
X-128cm  
Y-117cm  
Z-98,51m

NEBC203 E  
OBJECTO-Conta de colar  
MATERIAL-Xisto  
QUADRADO-D5  
X-128cm  
Y-117cm  
Z-98,51m

NEBC203 F  
OBJECTO-Conta de colar  
MATERIAL-Xisto  
QUADRADO-D5  
X-128cm  
Y-117cm  
Z-98,51m

NEBC203 G  
OBJECTO-Conta de colar  
MATERIAL-Xisto  
QUADRADO-D5  
X-128cm  
Y-117cm  
Z-98,51m

NEBC203 H  
OBJECTO-Conta de colar  
MATERIAL-Xisto  
QUADRADO-D5  
X-128cm  
Y-117cm  
Z-98,51m

NEBC203 I  
OBJECTO-Conta de colar  
MATERIAL-Xisto  
QUADRADO-D5  
X-128cm  
Y-117cm  
Z-98,51m

NEBC203 J  
OBJECTO-Conta de colar  
MATERIAL-Xisto  
QUADRADO-D5  
X-128cm  
Y-117cm  
Z-98,51m

N9BC203 L  
OBJECTO-Conta de colar  
MATERIAL-Xisto  
QUADRADO-D5  
X-128cm  
Y-117cm  
Z-98,51m

N9BC203 M  
OBJECTO-Conta de colar  
MATERIAL-Xisto  
QUADRADO-D5  
X-128cm  
Y-117cm  
Z-98,51m

N9BC204  
OBJECTO-Conta de colar  
MATERIAL-Xisto  
QUADRADO-D5  
X-  
Y-  
Z-98,51m

N9BC204 A  
OBJECTO-Conta de colar  
MATERIAL-Xisto  
QUADRADO-D5  
X-  
Y-  
Z-98,51m

N9BC204 B  
OBJECTO-Conta de colar  
MATERIAL-Xisto  
QUADRADO-D5  
X-  
Y-  
Z-98,51m

N9BC204 C  
OBJECTO-Conta de colar  
MATERIAL-Xisto  
QUADRADO-D5  
X-  
Y-  
Z-98,51m

N9BC205  
OBJECTO-Conta de colar  
MATERIAL-Xisto  
QUADRADO-D5  
X-113cm  
Y-60cm  
Z-98,51m

N9BC205 A  
OBJECTO-Conta de colar  
MATERIAL-Xisto  
QUADRADO-D5  
X-113cm  
Y-60cm  
Z-98,51m

N9BC205 B  
OBJECTO-Conta de colar  
MATERIAL-Xisto  
QUADRADO-D5  
X-113cm  
Y-60cm  
Z-98,51m

N9BC205 C  
OBJECTO-Conta de colar  
MATERIAL-Xisto  
QUADRADO-D5  
X-113cm  
Y-60cm  
Z-98,51m

N9BC205 D  
OBJECTO-Conta de colar  
MATERIAL-Xisto  
QUADRADO-D5  
X-113cm  
Y-60cm  
Z-98,51m

N9BC205 E  
OBJECTO-Conta de colar  
MATERIAL-Xisto  
QUADRADO-D5  
X-113cm  
Y-60cm  
Z-98,51m



N9BC205 F  
OBJECTO-Conta de colar  
MATERIAL-Xisto  
QUADRADO-D5  
X-113cm  
Y-60cm  
Z-98,51m

N9BC206  
OBJECTO-Conta de colar  
MATERIAL-Xisto  
QUADRADO-D5  
X-113cm  
Y-75cm  
Z-98,51m

N9BC206 A  
OBJECTO-Conta de colar  
MATERIAL-Xisto  
QUADRADO-D5  
X-113cm  
Y-75cm  
Z-98,51m

N9BC206 B  
OBJECTO-Conta de colar  
MATERIAL-Xisto  
QUADRADO-D5  
X-113cm  
Y-75cm  
Z-98,51m

N9BC206 C  
OBJECTO-Conta de colar  
MATERIAL-Xisto  
QUADRADO-D5  
X-113cm  
Y-75cm  
Z-98,51m

N9BC206 D  
OBJECTO-Conta de colar  
MATERIAL-Xisto  
QUADRADO-D5  
X-113cm  
Y-75cm  
Z-98,51m

N9BC206 E  
OBJECTO-Conta de colar  
MATERIAL-Xisto  
QUADRADO-D5  
X-113cm  
Y-75cm  
Z-98,51m

N9BC206 F  
OBJECTO-Conta de colar  
MATERIAL-Xisto  
QUADRADO-D5  
X-113cm  
Y-75cm  
Z-98,51m

N9BC206 G  
OBJECTO-Conta de colar  
MATERIAL-Xisto  
QUADRADO-D5  
X-113cm  
Y-75cm  
Z-98,51m

N9BC206 H  
OBJECTO-Conta de colar  
MATERIAL-Xisto  
QUADRADO-D5  
X-113cm  
Y-75cm  
Z-98,51m

N9BC207  
OBJECTO-Conta de colar  
MATERIAL-Xisto  
QUADRADO-D5  
X-  
Y-  
Z-98,61m

N9BC208  
OBJECTO-Conta de colar  
MATERIAL-Xisto  
QUADRADO-  
X-  
Y-  
Z-98,51m

N9BC209  
OBJECTO-Conta de colar  
MATERIAL-Xisto  
QUADRADO-D5  
X-16cm  
Y-63cm  
Z-98,51m

N9BC210  
OBJECTO-Conta de colar  
MATERIAL-Xisto  
QUADRADO-D5  
X-110cm  
Y-108cm  
Z-98,61m

N9BC211  
OBJECTO-Conta de colar  
MATERIAL-Xisto  
QUADRADO-D5  
X-68cm  
Y-82cm  
Z-98,45m

N9BC211 A  
OBJECTO-Conta de colar  
MATERIAL-Xisto  
QUADRADO-D5  
X-68cm  
Y-82cm  
Z-98,45m

N9BC211 B  
OBJECTO-Conta de colar  
MATERIAL-Xisto  
QUADRADO-D5  
X-68cm  
Y-82cm  
Z-98,45m

N9BC211 C  
OBJECTO-Conta de colar  
MATERIAL-Xisto  
QUADRADO-D5  
X-68cm  
Y-82cm  
Z-98,45m

N9BC211 D  
OBJECTO-Conta de colar  
MATERIAL-Xisto  
QUADRADO-D5  
X-68cm  
Y-82cm  
Z-98,45m

N9BC211 E  
OBJECTO-Conta de colar  
MATERIAL-Xisto  
QUADRADO-D5  
X-68cm  
Y-82cm  
Z-98,45m

N9BC211 F  
OBJECTO-Conta de colar  
MATERIAL-Xisto  
QUADRADO-D5  
X-68cm  
Y-82cm  
Z-98,45m

N9BC211 G  
OBJECTO-Conta de colar  
MATERIAL-Xisto  
QUADRADO-D5  
X-68cm  
Y-82cm  
Z-98,45m

N9BC211 H  
OBJECTO-Conta de colar  
MATERIAL-Xisto  
QUADRADO-D5  
X-68cm  
Y-82cm  
Z-98,45m

N9BC212  
OBJECTO-Conta de colar  
MATERIAL-Xisto  
QUADRADO-D5  
X-90cm  
Y-82cm  
Z-98,51m

NEBC212 A  
OBJECTO-Conta de colar  
MATERIAL-Xisto  
QUADRADO-D5  
X-90cm  
Y-82cm  
Z-98,51m

NEBC212 B  
OBJECTO-Conta de colar  
MATERIAL-Xisto  
QUADRADO-D5  
X-90cm  
Y-82cm  
Z-98,51m

NEBC212 C  
OBJECTO-Conta de colar  
MATERIAL-Xisto  
QUADRADO-D5  
X-90cm  
Y-82cm  
Z-98,51m

NEBC212 D  
OBJECTO-Conta de colar  
MATERIAL-Xisto  
QUADRADO-D5  
X-90cm  
Y-82cm  
Z-98,51m

NEBC212 E  
OBJECTO-Conta de colar  
MATERIAL-Xisto  
QUADRADO-D5  
X-90cm  
Y-82cm  
Z-98,51m

NEBC212 F  
OBJECTO-Conta de colar  
MATERIAL-Xisto  
QUADRADO-D5  
X-90cm  
Y-82cm  
Z-98,51m

NEBC212 G  
OBJECTO-Conta de colar  
MATERIAL-Xisto  
QUADRADO-D5  
X-90cm  
Y-82cm  
Z-98,51m

NEBC213  
OBJECTO-Conta de colar  
MATERIAL-Calaité  
QUADRADO-D5  
X-168cm  
Y-95cm  
Z-98,51m

NEBC214  
OBJECTO-Ponta de seta  
MATERIAL-Sillex  
QUADRADO-D5  
X-80cm  
Y-80cm  
Z-98,60m

NEBC215  
OBJECTO-Ponta de seta  
MATERIAL-Sillex  
QUADRADO-D5  
X-  
Y-  
Z-98,46m

NEBC216  
OBJECTO-Ponta de seta  
MATERIAL-Quartzó filoniano  
QUADRADO-E5  
X-  
Y-  
Z-98,81m

NEBC217  
OBJECTO-Ponta de seta  
MATERIAL-Quartzó filoniano  
QUADRADO-E5  
X-  
Y-  
Z-98,41m

N9BC218  
OBJECTO-Ponta de seta  
MATERIAL-Silex  
QUADRADO-D5  
X-163cm  
Y-78cm  
Z-98,45m

N9BC219  
OBJECTO-Ponta de seta  
MATERIAL-Silex  
QUADRADO-D5  
X-193cm  
Y-25cm  
Z-98,31m

N9BC220  
OBJECTO-Lámina  
MATERIAL-Silex  
QUADRADO-D5  
X-180cm  
Y-2cm  
Z-97,71m

N9BC221  
OBJECTO-Ponta de seta  
MATERIAL-Silex  
QUADRADO-E5  
X-  
Y-  
Z-98,36m

N9BC222  
OBJECTO-Lámina  
MATERIAL-Silex  
QUADRADO-C4  
X-100cm  
Y-52cm  
Z-98,26m

N9BC223  
OBJECTO-Ponta de seta  
MATERIAL-Quartzo filoniano  
QUADRADO-D5  
X-  
Y-  
Z-98,46m

N9BC224  
OBJECTO-Ponta de seta  
MATERIAL-Silex  
QUADRADO-  
X-  
Y-  
Z-  
Crivo

N9BC225  
OBJECTO-Ponta de seta  
MATERIAL-Silex  
QUADRADO-D5  
X-170cm  
Y-88cm  
Z-98,61m

N9BC226  
OBJECTO-Ponta de seta  
MATERIAL-Silex  
QUADRADO-D5  
X-200cm  
Y-115cm  
Z-98,66m

N9BC227  
OBJECTO-Ponta de seta  
MATERIAL-Silex  
QUADRADO-D5  
X-  
Y-  
Z-98,29m

N9BC229  
OBJECTO-Ponta de seta  
MATERIAL-Silex  
QUADRADO-D5  
X-130cm  
Y-20cm  
Z-98,51m

N9BC230  
OBJECTO-Ponta de seta  
MATERIAL-Silex  
QUADRADO-D5  
X-  
Y-  
Z-98,61m

N9BC231  
OBJECTO-Ponta de seta  
MATERIAL-Silex  
QUADRADO-D5  
X-57cm  
Y-62cm  
Z-98,97m

N9BC232  
OBJECTO-Ponta de seta  
MATERIAL-Silex  
QUADRADO-D5  
X-  
Y-  
Z-98,50m

N9BC233  
OBJECTO-Lamina  
MATERIAL-Silex  
QUADRADO-D5  
X-67cm  
Y-107cm  
Z-99,25m

N9BC234  
OBJECTO-Ponta de seta  
MATERIAL-Silex  
QUADRADO-D5  
X-180cm  
Y-10cm  
Z-97,51m

N9BC235  
OBJECTO-Ponta de seta  
MATERIAL-Quartzo filoniano  
QUADRADO-F4  
X-150cm  
Y-200cm  
Z-98,11m

N9BC236  
OBJECTO-Ponta de seta  
MATERIAL-Silex  
QUADRADO-D5  
X-10cm  
Y-270cm  
Z-99,51m

N9BC237  
OBJECTO-Ponta de seta  
MATERIAL-Silex  
QUADRADO-D5  
X-110cm  
Y-90cm  
Z-98,45m

N9BC238  
OBJECTO-Ponta de seta  
MATERIAL-Silex  
QUADRADO-D5  
X-68cm  
Y-92cm  
Z-98,45m

N9BC239  
OBJECTO-Lameia  
MATERIAL-Silex  
QUADRADO-D5  
X-150cm  
Y-40cm  
Z-98,46m

N9BC240  
OBJECTO-Ponta de seta  
MATERIAL-Quartzo filoniano  
QUADRADO-E5  
X-  
Y-  
Z-98,36m

N9BC241  
OBJECTO-Ponta de seta  
MATERIAL-Silex  
QUADRADO-D5  
X-119cm  
Y-20cm  
Z-98,56m

N9BC242  
OBJECTO-Ponta de seta  
MATERIAL-Silex  
QUADRADO-D5  
X-166cm  
Y-71cm  
Z-98,30m

N9BC243  
OBJECTO-Ponta de seta  
MATERIAL-Silex  
QUADRADO-D5  
X-  
Y-  
Z-98,56m

N9BC244  
OBJECTO-Ponta de seta  
MATERIAL-Silex  
QUADRADO-D5  
X-130cm  
Y-15cm  
Z-98,46m

N9BC246  
OBJECTO-Ponta de seta  
MATERIAL-Quartzo filoniano  
QUADRADO-D5  
X-140cm  
Y-22cm  
Z-98,46m

N9BC247  
OBJECTO-Ponta de seta  
MATERIAL-Quartzo hialino  
QUADRADO-D5  
X-138cm  
Y-25cm  
Z-98,35m

N9BC249  
OBJECTO-Ponta de seta  
MATERIAL-Quartzo filoniano  
QUADRADO-D5  
X-68cm  
Y-112cm  
Z-98,45m

N9BC250  
OBJECTO-Ponta de seta  
MATERIAL-Silex  
QUADRADO-D5  
X-68cm  
Y-92cm  
Z-98,45m

N9BC251  
OBJECTO-Ponta de seta  
MATERIAL-Silex  
QUADRADO-D5  
X-118cm  
Y-20cm  
Z-98,47m

N9BC252  
OBJECTO-Ponta de seta  
MATERIAL-Quartzo filoniano  
QUADRADO-D5  
X-180cm  
Y-10cm  
Z-97,51m

N9BC253  
OBJECTO-Ponta de seta  
MATERIAL-Silex  
QUADRADO-C5  
X-185cm  
Y-15cm  
Z-98,65m

N9BC254  
OBJECTO-Ponta de seta  
MATERIAL-Silex  
QUADRADO-D5  
X-150cm  
Y-40cm  
Z-98,46m

N9BC255  
OBJECTO-Lámina  
MATERIAL-Silex  
QUADRADO-E5  
X-41cm  
Y-20cm  
Z-98,81m

N9BC256  
OBJECTO-Lámina  
MATERIAL-Silex  
QUADRADO-D5  
X-118cm  
Y-20cm  
Z-98,47m

4  
N9BC257  
OBJECTO-Ponta de seta  
MATERIAL-Silex  
QUADRADO-D5  
X-20cm  
Y-40cm  
Z-98,50m

N9BC258  
OBJECTO-Ponta de seta  
MATERIAL-Quartzo hialino  
QUADRADO-D5  
X-94cm  
Y-96cm  
Z-98,14m

N9BC259  
OBJECTO-Ponta de seta  
MATERIAL-Silex  
QUADRADO-D5  
X-113cm  
Y-75cm  
Z-98,51m

N9BC260  
OBJECTO-Ponta de seta  
MATERIAL-Silex  
QUADRADO-D5  
X-113cm  
Y-75cm  
Z-98,51m

N9BC261  
OBJECTO-Ponta de seta  
MATERIAL-Silex  
QUADRADO-D5  
X-  
Y-  
Z-98,60m

N9BC262  
OBJECTO-Ponta de seta  
MATERIAL-Silex  
QUADRADO-D5  
X-68cm  
Y-92cm  
Z-98,45m

N9BC263  
OBJECTO-Ponta de seta  
MATERIAL-Quartzo hialino  
QUADRADO-D5  
X-128cm  
Y-117cm  
Z-98,51m

N9BC264  
OBJECTO-Ponta de seta  
MATERIAL-Silex  
QUADRADO-D5  
X-128cm  
Y-122cm  
Z-98,51m

N9BC265  
OBJECTO-Ponta de seta  
MATERIAL-Silex  
QUADRADO-C5  
X-184cm  
Y-21cm  
Z-98,08m

N9BC266  
OBJECTO-Ponta de seta  
MATERIAL-Quartzo hialino  
QUADRADO-D1  
X-180cm  
Y-20cm  
Z-97,96m

N9BC267  
OBJECTO-Ponta de seta  
MATERIAL-Silex  
QUADRADO-D5  
X-84cm  
Y-69cm  
Z-98,40m

N9BC268  
OBJECTO-Ponta de seta  
MATERIAL-Quartzo filoniano  
QUADRADO-D5  
X-60cm  
Y-137cm  
Z-98,23m

N9BC276  
OBJECTO-Ponta de seta  
MATERIAL-Silex  
QUADRADO-D5  
X-140cm  
Y-40cm  
Z-98,46m

N9BC277  
OBJECTO-Ponta de seta  
MATERIAL-Silex  
QUADRADO-D5  
X-124cm  
Y-16cm  
Z-98,51m

N9BC278  
OBJECTO-Ponta de seta  
MATERIAL-Silex  
QUADRADO-D5  
X-88cm  
Y-39cm  
Z-98,61m

N9BC279  
OBJECTO-Lámina  
MATERIAL-Silex  
QUADRADO-D5  
X-192cm  
Y-28cm  
Z-98,49m

N9BC280  
OBJECTO-Ponta de seta  
MATERIAL-Quartzo filoniano  
QUADRADO-D5  
X-150cm  
Y-40cm  
Z-98,46m

N9BC281  
OBJECTO-Ponta de seta  
MATERIAL-Silex  
QUADRADO-E4  
X-178cm  
Y-198cm  
Z-98,36m

N9BC269  
OBJECTO-Ponta de seta  
MATERIAL-Silex  
QUADRADO-D5  
X-90cm  
Y-50cm  
Z-98,70m

N9BC270  
OBJECTO-Ponta de seta  
MATERIAL-Silex  
QUADRADO-D5  
X-101cm  
Y-128cm  
Z-98,51m

N9BC271  
OBJECTO-Ponta de seta  
MATERIAL-Quartzo hialino  
QUADRADO-D5  
X-  
Y-  
Z-98,08m

N9BC273  
OBJECTO-Ponta de seta  
MATERIAL-Silex  
QUADRADO-D5  
X-78cm  
Y-188cm  
Z-98,13m

N9BC274  
OBJECTO-Ponta de seta  
MATERIAL-Silex  
QUADRADO-D5  
X-132cm  
Y-166cm  
Z-98,61m

N9BC275  
OBJECTO-Ponta de seta  
MATERIAL-Quartzo filoniano  
QUADRADO-D5  
X-113cm  
Y-75cm  
Z-98,51m



N9BC282  
OBJECTO-Ponta de seta  
MATERIAL-Sillex  
QUADRADO-D5  
X-  
Y-  
Z-98,40m

N9BC283  
OBJECTO-Ponta de seta  
MATERIAL-Sillex  
QUADRADO-D5  
X-128cm  
Y-107cm  
Z-98,61m

N9BC284  
OBJECTO-Ponta de seta  
MATERIAL-Sillex  
QUADRADO-D5  
X-175cm  
Y-35cm  
Z-98,30m

N9BC285  
OBJECTO-Ponta de seta  
MATERIAL-Xisto jasp6ide  
QUADRADO-D5  
X-162cm  
Y-110cm  
Z-98,51m

N9BC287  
OBJECTO-Ponta de seta  
MATERIAL-Sillex  
QUADRADO-D5  
X-100cm  
Y-134cm  
Z-98,91m

N9BC288  
OBJECTO-Ponta de seta  
MATERIAL-Quartzo hialino  
QUADRADO-D5  
X-130cm  
Y-25cm  
Z-98,46m

N9BC289  
OBJECTO-Ponta de seta  
MATERIAL-Sillex  
QUADRADO-D5  
X-  
Y-  
Z-98,51m

N9BC290  
OBJECTO-Ponta de seta  
MATERIAL-Sillex  
QUADRADO-D5  
X-  
Y-  
Z-98,40m

N9BC291  
OBJECTO-Ponta de seta  
MATERIAL-Quartzo filoniano  
QUADRADO-D5  
X-92cm  
Y-66cm  
Z-98,91m

N9BC292  
OBJECTO-Ponta de seta  
MATERIAL-Sillex  
QUADRADO-D5  
X-142cm  
Y-43cm  
Z-98,61m

N9BC296  
OBJECTO-Geom6trico  
MATERIAL-Sillex  
QUADRADO-D4  
X-10cm  
Y-100cm  
Z-98,11m

N9BC297  
OBJECTO-Peso de pesca (?)  
MATERIAL-Anfibolite  
QUADRADO-E5  
X-74cm  
Y-66cm  
Z-98,97m

NºBC298  
OBJECTO-Peso de pesca (?)  
MATERIAL-Anfibolite  
QUADRADO-E5  
X-34cm  
Y-112cm  
Z-98,22m

NºBC299  
OBJECTO-Percutor  
MATERIAL-Quartzito  
QUADRADO-D5  
X-102cm  
Y-142cm  
Z-98,91m

NºBC301  
OBJECTO-Percutor  
MATERIAL-Quartzito  
QUADRADO-D5  
X-95cm  
Y-10cm  
Z-98,50m

NºBC302  
OBJECTO-Ponta de seta  
MATERIAL-Quartzito hialino  
QUADRADO-D5  
X-178cm  
Y-25cm  
Z-98,29m

NºBC305  
OBJECTO-Fragmento de lâmina  
MATERIAL-Sílex  
QUADRADO-  
X-  
Y-  
Z-  
Superfície-masmoa

NºBC306  
OBJECTO-Lamelas  
MATERIAL-Sílex  
QUADRADO-D5  
X-  
Y-  
Z-98,51m

NºBC311  
OBJECTO-Taça carenada  
MATERIAL-Cerâmica  
QUADRADO-D5  
X-88cm  
Y-39cm  
Z-98,61m

NºBC315  
OBJECTO-Fragmento de taça  
MATERIAL-Cerâmica  
QUADRADO-D5  
X-17cm  
Y-45cm  
Z-98,51m

NºBC317  
OBJECTO-Taça  
MATERIAL-Cerâmica  
QUADRADO-D5  
X-168cm  
Y-20cm  
Z-98,66m

NºBC319  
OBJECTO-Taça  
MATERIAL-Cerâmica  
QUADRADO-D5  
X-101cm  
Y-183cm  
Z-98,96m

NºBC321  
OBJECTO-Fragmento de taça (?)  
MATERIAL-Cerâmica  
QUADRADO-E5  
X-20cm  
Y-119cm  
Z-99,87m

NºBC324  
OBJECTO-Fragmento de prato (?)  
MATERIAL-Cerâmica  
QUADRADO-E6  
X-60cm  
Y-190cm  
Z-98,95m

N9BC325  
OBJETO-Fragmento de taca  
MATERIAL-Cerâmica  
QUADRADO-E4  
X-200cm  
Y-136cm  
Z-98,16m

N9BC328  
OBJETO-Fragmento de taca semi-esférico  
MATERIAL-Cerâmica  
QUADRADO-D5  
X-139cm  
Y-60cm  
Z-98,03m

N9BC330  
OBJETO-Fragmento de taca  
MATERIAL-Cerâmica  
QUADRADO-E5  
X-70cm  
Y-29cm  
Z-99,00m

N9BC331  
OBJETO-Fragmento de taca  
MATERIAL-Cerâmica  
QUADRADO-D5  
X-113cm  
Y-128cm  
Z-98,91m

N9BC332  
OBJETO-Fragmento de taca  
MATERIAL-Cerâmica  
QUADRADO-D5  
X-180cm  
Y-40cm  
Z-98,11cm

N9BC335  
OBJETO-Fragmento de taca (?)  
MATERIAL-Cerâmica  
QUADRADO-E5  
X-110cm  
Y-9cm  
Z-98,73m

N9BC336  
OBJETO-Fragmento de taca  
MATERIAL-Cerâmica  
QUADRADO-D5  
X-81cm  
Y-136cm  
Z-98,75m

N9BC337  
OBJETO-Fragmento de taca  
MATERIAL-Cerâmica  
QUADRADO-D5  
X-180cm  
Y-10cm  
Z-97,51m

N9BC339  
OBJETO-Fragmento de taca (?)  
MATERIAL-Cerâmica  
QUADRADO-D5  
X-65cm  
Y-164cm  
Z-98,75m

N9BC341  
OBJETO-Fragmento de taca (?)  
MATERIAL-Cerâmica  
QUADRADO-B5  
X-150cm  
Y-15cm  
Z-99,01m

N9BC342  
OBJETO-Taca carenada  
MATERIAL-Cerâmica  
QUADRADO-D5  
X-75cm  
Y-20cm  
Z-98,70m

N9BC344  
OBJETO-Fragmento de taca  
MATERIAL-Cerâmica  
QUADRADO-F5  
X-100cm  
Y-0cm  
Z-98,94m

N9BC345  
 OBJECTO-Fragmento de taça carenada  
 MATERIAL-Cerâmica  
 QUADRADO-E5  
 X-15cm  
 Y-130cm  
 Z-98,76m

N9BC346  
 OBJECTO-Fragmento de taça  
 MATERIAL-Cerâmica  
 QUADRADO-D5  
 X-180cm  
 Y-10cm  
 Z-97,51m

N9BC347  
 OBJECTO-Fragmento de taça  
 MATERIAL-Cerâmica  
 QUADRADO-D5  
 X-129cm  
 Y-118cm  
 Z-98,60m

N9BC348  
 OBJECTO-Fragmento de taça  
 MATERIAL-Cerâmica  
 QUADRADO-E5  
 X-84cm  
 Y-146cm  
 Z-99,56m

N9BC349  
 OBJECTO-Fragmento de taça  
 MATERIAL-Cerâmica  
 QUADRADO-E4  
 X-173cm  
 Y-180cm  
 Z-98,36m

N9BC350  
 OBJECTO-Fragmento de Taça  
 MATERIAL-Cerâmica  
 QUADRADO-D5  
 X-10cm  
 Y-5cm  
 Z-98,40m

N9BC351  
 OBJECTO-Fragmento de taça  
 MATERIAL-Cerâmica  
 QUADRADO-E5  
 X-110cm  
 Y-9cm  
 Z-98,73m

N9BC352  
 OBJECTO-Fragmento de taça  
 MATERIAL-Cerâmica  
 QUADRADO-D5  
 X-90cm  
 Y-143cm  
 Z-98,08m

N9BC355  
 OBJECTO-Taça semi-esférica  
 MATERIAL-Cerâmica  
 QUADRADO-E5  
 X-165cm  
 Y-35cm  
 Z-99,15m

N9BC356  
 OBJECTO-Fragmento de prato  
 MATERIAL-Cerâmica  
 QUADRADO-E5  
 X-28cm  
 Y-112cm  
 Z-90,09m

N9BC357  
 OBJECTO-Fragmento de taça (?)  
 MATERIAL-Cerâmica  
 QUADRADO-E5  
 X-66cm  
 Y-87cm  
 Z-98,91m

N9BC358  
 OBJECTO-Fragmento de taça  
 MATERIAL-Cerâmica  
 QUADRADO-D5  
 X-180cm  
 Y-10cm  
 Z-97,10m

N9BC359  
OBJETO-Fragmento de taça  
MATERIAL-Cerâmica  
QUADRADO-D5  
X-  
Y-  
Z-  
Crivo

N9BC361  
OBJETO-Lamela  
MATERIAL-Quartzó hialino  
QUADRADO-D5  
X-  
Y-  
Z-  
Crivo

N9BC362  
OBJETO-Fragmento de taça  
MATERIAL-Cerâmica  
QUADRADO-F4  
X-3cm  
Y-114cm  
Z-99,05m

N9BC363  
OBJETO-Fragmento de taça  
MATERIAL-Cerâmica  
QUADRADO-F4  
X-3cm  
Y-114cm  
Z-99,05m

N9BC364  
OBJETO-Fragmento de taça  
MATERIAL-Cerâmica  
QUADRADO-D4  
X-53cm  
Y-186cm  
Z-99,18m

N9BC365  
OBJETO-Fragmento de taça semi-esférica  
MATERIAL-Cerâmica  
QUADRADO-D4  
X-53cm  
Y-186cm  
Z-99,18m

N9BC366  
OBJETO-Fragmento de taça semi-esférica  
MATERIAL-Cerâmica  
QUADRADO-F4  
X-32cm  
Y-150cm  
Z-99,74m

N9BC367  
OBJETO-Fragmento de taça semi-esférica  
MATERIAL-Cerâmica  
QUADRADO-D4  
X-20cm  
Y-123cm  
Z-99,28m

N9BC368  
OBJETO-Fragmento de taça carenada  
MATERIAL-Cerâmica  
QUADRADO-F4  
X-200cm  
Y-136cm  
Z-99,16m

N9BC369  
OBJETO-Fragmento de taça  
MATERIAL-Cerâmica  
QUADRADO-D5  
X-10cm  
Y-5cm  
Z-99,40m

N9BC370  
OBJETO-Fragmento de taça semi-esférica  
MATERIAL-Cerâmica  
QUADRADO-E5  
X-110cm  
Y-9cm  
Z-99,73m

N9BC371  
OBJETO-Fragmento de taça  
MATERIAL-Cerâmica  
QUADRADO-D4  
X-  
Y-  
Z-  
Crivo

N9BC372  
 OBJECTO-Ponta de seta  
 MATERIAL-Quartzo hialino  
 QUADRADO-D5  
 X-  
 Y-  
 Z-  
 Crivo

N9BC373  
 OBJECTO-Ponta de seta  
 MATERIAL-Quartzo filoniano  
 QUADRADO-  
 X-  
 Y-  
 Z-  
 Crivo

N9BC374  
 OBJECTO-Elemento de mó (dormente)  
 MATERIAL-Granito  
 QUADRADO-  
 X-  
 Y-  
 Z-  
 Superficie-mamoa

N9  
 OBJECTO-  
 MATERIAL-  
 QUADRADO-  
 X-  
 Y-  
 Z-

N9  
 OBJECTO-  
 MATERIAL-  
 QUADRADO-  
 X-  
 Y-  
 Z-

N9  
 OBJECTO-  
 MATERIAL-  
 QUADRADO-  
 X-  
 Y-  
 Z-



ANTA  
da  
**CABEÇUDA**





ANTA DA CABEÇUDA

N9C1  
 OBJECTO-Ponta de seta  
 MATERIAL-Silex  
 QUADRADO-H8 (Revolvimento)  
 X-  
 Y-  
 Z-

N9C2  
 OBJECTO-Ponta de seta  
 MATERIAL-Silex  
 QUADRADO-H7 (Revolvimento)  
 X-  
 Y-  
 Z-

N9C3  
 OBJECTO-Ponta de seta  
 MATERIAL-Quartzó filoniano  
 QUADRADO-H7 (Revolvimento)  
 X-  
 Y-  
 Z-154cm

N9C4  
 OBJECTO-Ponta de seta  
 MATERIAL-Silex  
 QUADRADO-H7 (Revolvimento)  
 X-  
 Y-  
 Z-

N9C5  
 OBJECTO-Ponta de seta  
 MATERIAL-Silex  
 QUADRADO-H7 (Revolvimento)  
 X-  
 Y-  
 Z-

N9C6  
 OBJECTO-Ponta de seta  
 MATERIAL-Silex  
 QUADRADO-G7 (Revolvimento)  
 X-  
 Y-  
 Z-

N9C7  
 OBJECTO-Ponta de seta  
 MATERIAL-Quartzó filoniano  
 QUADRADO-H8 (Revolvimento)  
 X-  
 Y-  
 Z-

N9C8  
 OBJECTO-Ponta de seta  
 MATERIAL-Silex  
 QUADRADO-G8 (Revolvimento)  
 X-  
 Y-  
 Z-

N9C9  
 OBJECTO-Ponta de seta  
 MATERIAL-Silex  
 QUADRADO-G8 (Revolvimento)  
 X-  
 Y-  
 Z-

N9C10  
 OBJECTO-Ponta de seta  
 MATERIAL-Silex  
 QUADRADO-G8 (Revolvimento)  
 X-  
 Y-  
 Z-

N9C11  
 OBJECTO-Ponta de seta  
 MATERIAL-Silex  
 QUADRADO-I9 (Revolvimento)  
 X-  
 Y-  
 Z-130cm

N9C12  
 OBJECTO-Ponta de seta  
 MATERIAL-Silex  
 QUADRADO-H8  
 X-195cm  
 Y-35cm  
 Z-141cm

N9C13  
OBJECTO-Ponta de seta  
MATERIAL-Sillex  
QUADRADO-G7 (Revolvimento)  
X-  
Y-  
Z-

N9C14  
OBJECTO-Ponta de seta  
MATERIAL-Sillex  
QUADRADO-I7  
X-50cm  
Y-30cm  
Z-141cm

N9C15  
OBJECTO-Ponta de seta  
MATERIAL-Quartzo filoniano  
QUADRADO-I7  
X-  
Y-  
Z-155

N9C16  
OBJECTO-Ponta de seta  
MATERIAL-Sillex  
QUADRADO-H7 (Revolvimento)  
X-  
Y-  
Z-

N9C17  
OBJECTO-Ponta de seta  
MATERIAL-Sillex  
QUADRADO-L7  
X-  
Y-  
Z-157cm

N9C18  
OBJECTO-Ponta de seta  
MATERIAL-Sillex  
QUADRADO-G8 (Revolvimento)  
X-  
Y-  
Z-

N9C19  
OBJECTO-Ponta de seta  
MATERIAL-Sillex  
QUADRADO-J7  
X-  
Y-  
Z-160cm

N9C20  
OBJECTO-Ponta de seta  
MATERIAL-Quartzo hialino  
QUADRADO-L8  
X-  
Y-  
Z-174cm

N9C21  
OBJECTO-Ponta de seta  
MATERIAL-Sillex  
QUADRADO-L7 (Revolvimento)  
X-  
Y-  
Z-

N9C22  
OBJECTO-Ponta de seta  
MATERIAL-Sillex  
QUADRADO-J8 (Revolvimento)  
X-  
Y-  
Z-

N9C23  
OBJECTO-Ponta de seta  
MATERIAL-Quartzo filoniano  
QUADRADO-G7  
X-  
Y-  
Z-140cm

N9C24  
OBJECTO-Ponta de seta  
MATERIAL-Sillex  
QUADRADO-H8  
X-  
Y-  
Z-138cm

N9C25  
OBJECTO-Ponta de seta  
MATERIAL-Silex  
QUADRADO-H8  
X-  
Y-  
Z-140cm

N9C26  
OBJECTO-Ponta de seta  
MATERIAL-Quartzo Filoniano  
QUADRADO-H7  
X-  
Y-  
Z-141

N9C27  
OBJECTO-Ponta de seta  
MATERIAL-Quartzo filoniano  
QUADRADO-I7 (Revolvimento)  
X-  
Y-  
Z-

N9C28  
OBJECTO-Ponta de seta  
MATERIAL-Silex  
QUADRADO-I7  
X-  
Y-  
Z-Superficie

N9C29  
OBJECTO-Ponta de seta  
MATERIAL-Quartzo filoniano  
QUADRADO-H7  
X-  
Y-  
Z-155cm

N9C30  
OBJECTO-Ponta de seta  
MATERIAL-Xisto jasteoide  
QUADRADO-I7  
X-40cm  
Y-190cm  
Z-141cm

N9C31  
OBJECTO-Ponta de seta  
MATERIAL-Quartzo hialino  
QUADRADO-H8  
X-  
Y-  
Z-140cm

N9C32  
OBJECTO-Ponta de seta  
MATERIAL-Quartzo filoniano  
QUADRADO-G7  
X-60cm  
Y-50cm  
Z-155cm

N9C33  
OBJECTO-Ponta de seta  
MATERIAL-Silex  
QUADRADO-G8  
X-140cm  
Y-60cm  
Z-155cm

N9C34  
OBJECTO-Ponta de seta  
MATERIAL-Silex  
QUADRADO-J7  
X-30cm  
Y-156cm  
Z-104cm

N9C35  
OBJECTO-Ponta de seta  
MATERIAL-Silex  
QUADRADO-? Câmara  
X-  
Y-  
Z-155cm

N9C36  
OBJECTO-Ponta de seta  
MATERIAL-Silex  
QUADRADO-H7  
X-  
Y-  
Z-138cm

Ngc37  
OBJECTO-Ponta de seta  
MATERIAL-Silex  
QUADRADO-H7  
X-  
Y-  
Z-149cm

Ngc38  
OBJECTO-Ponta de seta  
MATERIAL-Silex  
QUADRADO-H7  
X-  
Y-  
Z-149cm

Ngc39  
OBJECTO-Ponta de seta  
MATERIAL-Silex  
QUADRADO-L7  
X-  
Y-  
Z-146cm

Ngc40  
OBJECTO-Ponta de seta  
MATERIAL-Silex  
QUADRADO-L7  
X-145cm  
Y-40cm  
Z-155cm

Ngc41  
OBJECTO-Ponta de seta  
MATERIAL-Silex  
QUADRADO-L7  
X-  
Y-  
Z-171cm

Ngc42  
OBJECTO-Ponta de seta  
MATERIAL-Quartzo hialino  
QUADRADO-L7  
X-90cm  
Y-102cm  
Z-152cm

Ngc43  
OBJECTO-Ponta de seta  
MATERIAL-Silex  
QUADRADO-H8  
X-90cm  
Y-50cm  
Z-163cm

Ngc44  
OBJECTO-Ponta de seta  
MATERIAL-Silex  
QUADRADO-? Namoa  
X-  
Y-  
Z-Superficie

Ngc45  
OBJECTO-Ponta de seta  
MATERIAL-Silex  
QUADRADO-L8  
X-180cm  
Y-70cm  
Z-163cm

Ngc46  
OBJECTO-Ponta de seta  
MATERIAL-Silex  
QUADRADO-L7  
X-139cm  
Y-50cm  
Z-155cm

Ngc46a  
OBJECTO-Ponta de seta  
MATERIAL-Silex  
QUADRADO-L7  
X-139cm  
Y-50cm  
Z-155cm

Ngc47  
OBJECTO-Conta de colar  
MATERIAL-Xisto  
QUADRADO-G8  
X-110cm  
Y-110cm  
Z-152cm

N9C48  
OBJECTO-Conta de colar  
MATERIAL-Xisto  
QUADRADO-G8  
X-110cm  
Y-110cm  
Z-152cm

N9C49  
OBJECTO-Conta de colar  
MATERIAL-Xisto  
QUADRADO-G8  
X-110cm  
Y-110cm  
Z-152cm

N9C50  
OBJECTO-Conta de colar  
MATERIAL-Xisto  
QUADRADO-G8  
X-110cm  
Y-110cm  
Z-152cm

N9C51  
OBJECTO-Fragmento de conta de colar  
MATERIAL-Xisto  
QUADRADO-G8  
X-110cm  
Y-110cm  
Z-152cm

N9C52  
OBJECTO-Conta de colar  
MATERIAL-Xisto  
QUADRADO-H8  
X-  
Y-  
Z-140cm

N9C53  
OBJECTO-Conta de colar  
MATERIAL-Xisto  
QUADRADO-H8  
X-  
Y-  
Z-134cm

N9C54  
OBJECTO-Conta de colar  
MATERIAL-Xisto  
QUADRADO-H8  
X-  
Y-  
Z-134cm

N9C55  
OBJECTO-Conta de colar  
MATERIAL-Xisto  
QUADRADO-H7  
X-  
Y-  
Z-138cm

N9C56  
OBJECTO-Conta de colar  
MATERIAL-Xisto  
QUADRADO-I7  
X-30cm  
Y-10cm  
Z-154cm

N9C57  
OBJECTO-Conta de colar  
MATERIAL-Xisto  
QUADRADO-G7  
X-  
Y-  
Z-155cm

N9C58  
OBJECTO-Conta de colar  
MATERIAL-Xisto  
QUADRADO-I7  
X-  
Y-  
Z-Superficie

N9C59  
OBJECTO-Conta de colar  
MATERIAL-Xisto  
QUADRADO-I7  
X-  
Y-  
Z-Superficie 41

N9C60  
OBJECTO-Conta de colar  
MATERIAL-Xisto  
QUADRADO-I7  
X-  
Y-  
Z-171cm

N9C61  
OBJECTO-Conta de colar  
MATERIAL-Xisto  
QUADRADO-J7  
X-  
Y-  
Z-Superficie

N9C62  
OBJECTO-Conta de colar  
MATERIAL-Xisto  
QUADRADO-J7  
X-  
Y-  
Z-165cm

N9C63  
OBJECTO-Conta de colar  
MATERIAL-Xisto  
QUADRADO-J7  
X-  
Y-  
Z-

N9C64  
OBJECTO-Conta de colar  
MATERIAL-Xisto  
QUADRADO-J7  
X-  
Y-  
Z-

N9C65  
OBJECTO-Conta de colar  
MATERIAL-Xisto  
QUADRADO-J7  
X-  
Y-  
Z-

N9C66  
OBJECTO-Conta de colar  
MATERIAL-Ámbar  
QUADRADO-H7 (Revolvimento)  
X-  
Y-  
Z-

N9C67  
OBJECTO-Conta de colar  
MATERIAL-Xisto  
QUADRADO-H7 (Revolvimento)  
X-  
Y-  
Z-

N9C69  
OBJECTO-Conta de colar  
MATERIAL-Xisto  
QUADRADO-H7 (Revolvimento)  
X-  
Y-  
Z-

N9C70  
OBJECTO-Conta de colar  
MATERIAL-Xisto  
QUADRADO-H7 (Revolvimento)  
X-  
Y-  
Z-

N9C71  
OBJECTO-Geométrico  
MATERIAL-Sílex  
QUADRADO-G8  
X-  
Y-  
Z-154cm

N9C72  
OBJECTO-Geométrico  
MATERIAL-Sílex  
QUADRADO-G8  
X-  
Y-  
Z-141cm

N9C73  
OBJECTO-Geométrico  
MATERIAL-Silex  
CUADRADO-G7 (Revolvimiento)  
X-  
Y-  
Z-138cm

N9C74  
OBJECTO-Geométrico  
MATERIAL-Silex  
CUADRADO-I7  
X-  
Y-  
Z-Superficie

N9C75  
OBJECTO-Geométrico  
MATERIAL-Silex  
CUADRADO-I7  
X-  
Y-  
Z-Superficie

N9C76  
OBJECTO-Geométrico  
MATERIAL-Silex  
CUADRADO-J7  
X-  
Y-  
Z-165cm

N9C77  
OBJECTO-Geométrico  
MATERIAL-Silex  
CUADRADO-? (mamoa)  
X-  
Y-  
Z-

N9C78  
OBJECTO-Geométrico  
MATERIAL-Silex  
CUADRADO-G7  
X-  
Y-  
Z-155cm

N9C79  
OBJECTO-Geométrico  
MATERIAL-Silex  
CUADRADO-H8  
X-  
Y-  
Z-138cm

N9C80  
OBJECTO-Fragmento de lámina  
MATERIAL-Silex  
CUADRADO-G7  
X-  
Y-  
Z-155cm

N9C91  
OBJECTO-Fragmento de lámina  
MATERIAL-Silex  
CUADRADO-G8  
X-70cm  
Y-100cm  
Z-100cm

N9C82  
OBJECTO-Fragmento de lámina  
MATERIAL-Silex  
CUADRADO-H8  
X-  
Y-  
Z-140cm

N9C83  
OBJECTO-Fragmento de lámina  
MATERIAL-Silex  
CUADRADO-L8 (Revolvimiento)  
X-  
Y-  
Z-

N9C84  
OBJECTO-Fragmento de lámina  
MATERIAL-Silex  
CUADRADO-H7  
X-65cm  
Y-80cm  
Z-91cm



N9C85  
OBJECTO-Fragmento de lâmina  
MATERIAL-Silex  
QUADRADO-H8  
X-  
Y-  
Z-134cm

N9C86  
OBJECTO-Fragmento de lâmina  
MATERIAL-Silex  
QUADRADO-H7  
X-  
Y-  
Z-149cm

N9C87  
OBJECTO-Fragmento de lâmina  
MATERIAL-Silex  
QUADRADO-L7  
X-152cm  
Y-112cm  
Z-169cm

N9C88  
OBJECTO-Fragmento de lâmina  
MATERIAL-Silex  
QUADRADO-M8  
X-130cm  
Y-60cm  
Z-188cm

N9C91  
OBJECTO-Pendente  
MATERIAL-?  
QUADRADO-I7  
X-  
Y-  
Z-170cm

N9C91a  
OBJECTO-Pendente  
MATERIAL-Rocha verde  
QUADRADO-J7  
X-180cm  
Y-50cm  
Z-174cm

N9C96  
OBJECTO-Resto de talhe  
MATERIAL-Silex  
QUADRADO-G7  
X-  
Y-  
Z-155cm

N9C98  
OBJECTO-Fragmento de lâmina  
MATERIAL-Silex  
QUADRADO-L7  
X-  
Y-  
Z-168cm

N9C99  
OBJECTO-Fragmento de lâmina  
MATERIAL-Silex  
QUADRADO-H7  
X-  
Y-  
Z-138cm

N9C100  
OBJECTO-Fragmento de lâmina  
MATERIAL-Silex  
QUADRADO-H7  
X-  
Y-  
Z-141cm

N9C101  
OBJECTO-Machado  
MATERIAL-Anfibolite  
QUADRADO-H7  
X-20cm  
Y-200cm  
Z-170cm  
(Interior do silo(?))

N9C102  
OBJECTO-Fragmento de machado (?)  
MATERIAL-Anfibolite  
QUADRADO-L7  
X-13cm  
Y-88cm  
Z-Superfície

N9C104  
 OBJECTO-Machado  
 MATERIAL-Anfibolite  
 QUADRADO-? (Mamoa)  
 X-  
 Y-  
 Z-Superficie

N9C105  
 OBJECTO-Fragmento de taça semi-esférica  
 MATERIAL-Cerâmica  
 QUADRADO-H8 (Revolvimento)  
 X-  
 Y-  
 Z-138cm

N9C106  
 OBJECTO-Fragmento de vaso com asa  
 MATERIAL-Cerâmica  
 QUADRADO-J7  
 X-60cm  
 Y-140cm  
 Z-137cm

N9C107  
 OBJECTO-Taça com mamilos de fundo plano  
 MATERIAL-Cerâmica  
 QUADRADO-H7  
 X-100cm  
 Y-15cm  
 Z-154cm

N9C108  
 OBJECTO-Taça de fundo plano  
 MATERIAL-Cerâmica  
 QUADRADO-G8  
 X-80cm  
 Y-140cm  
 Z-143cm

N9C109  
 OBJECTO-Machado  
 MATERIAL-Anfibolite  
 QUADRADO-? (Mamoa)  
 X-  
 Y-  
 Z-Superficie

N9C110  
 OBJECTO-Machado  
 MATERIAL-Machado  
 QUADRADO-I5  
 X-200cm  
 Y-20cm  
 Z-Superficie

N9C111  
 OBJECTO-Fragmento de machado (Talão)  
 MATERIAL-Anfibolite  
 QUADRADO-L7  
 X-33cm  
 Y-136cm  
 Z-165cm

N9C112  
 OBJECTO-Machado (?)  
 MATERIAL-Anfibolite  
 QUADRADO-J7  
 X-105cm  
 Y-60cm  
 Z-175cm

N9C113  
 OBJECTO-Fragmento de machado  
 MATERIAL-Anfibolite  
 QUADRADO-L7  
 X-  
 Y-  
 Z-Superficie

N9C114  
 OBJECTO-Machado  
 MATERIAL-Anfibolite  
 QUADRADO-I5  
 X-200cm  
 Y-20cm  
 Z-Superficie

N9C115  
 OBJECTO-Machado  
 MATERIAL-Anfibolite  
 QUADRADO-I4  
 X-150cm  
 Y-170cm  
 Z-165cm

N9C115a  
OBJECTO-Enxó  
MATERIAL-Anfibolite  
QUADRADO-I7  
X-103cm  
Y-75cm  
Z-168cm

N9C116  
OBJECTO-Fragmento de idolo-placa  
MATERIAL-Grés  
QUADRADO-L7  
X-75cm  
Y-170cm  
Z-159cm

N9C118  
OBJECTO-Fragmento de idolo-placa  
MATERIAL-Grés  
QUADRADO-J7  
X-160cm  
Y-125cm  
Z-156cm

N9C120  
OBJECTO-Esfera  
MATERIAL-Granito  
QUADRADO-G8  
X-  
Y-  
Z-155

N9C121  
OBJECTO-Fragmento de idolo-placa  
MATERIAL-Xisto  
QUADRADO-J7  
X-75cm  
Y-125cm  
Z-150cm

N9C122  
OBJECTO-Fragmento de idolo-placa  
MATERIAL-Xisto  
QUADRADO-H7  
X-  
Y-  
Z-Superficie

N9C123  
OBJECTO-Fragmento de idolo-placa  
MATERIAL-Xisto  
QUADRADO-L7  
X-35cm  
Y-85cm  
Z-159cm

N9C124  
OBJECTO-Fragmento de idolo-placa  
MATERIAL-Grés  
QUADRADO-L7  
X-  
Y-  
Z-Superficie

N9C126  
OBJECTO-Fragmento de idolo-placa  
MATERIAL-Grés  
QUADRADO-J7  
X-160cm  
Y-125cm  
Z-156cm

N9C129  
OBJECTO-Fragmento de taça semi-esférica  
MATERIAL-Cerâmica  
QUADRADO-G8 (Câmara)  
X-  
Y-  
Z-Superficie

N9C131  
OBJECTO-Fragmento de taça semi-esférica  
MATERIAL-Cerâmica  
QUADRADO-H8 (Câmara)  
X-  
Y-  
Z-134cm

N9C132  
OBJECTO-Fragmento de taça semi-esférica  
MATERIAL-Cerâmica  
QUADRADO-H9 (Câmara)  
X-  
Y-  
Z-134cm

NºC135  
OBJECTO-Fragmento de taça (?)  
MATERIAL-Cerâmica  
QUADRADO-H8 (zona de revolvimento da câmara)  
X-  
Y-  
Z-

NºC136  
OBJECTO-Fragmento de taça semi-esférica  
MATERIAL-Cerâmica  
QUADRADO-H8 (zona de revolvimento da câmara)  
X-  
Y-  
Z-

NºC137  
OBJECTO-Fragmento de taça semi-esférica  
MATERIAL-Cerâmica  
QUADRADO-H8 (zona de revolvimento da câmara)  
X-  
Y-  
Z-

NºC138  
OBJECTO-Fragmento de taça carenada  
MATERIAL-Cerâmica  
QUADRADO-I8  
X-100cm  
Y-70cm  
Z-158cm

NºC140  
OBJECTO-Fragmento de taça esférica  
MATERIAL-Cerâmica  
QUADRADO-H8 (zona de revolvimento da câmara)  
X-  
Y-  
Z-

NºC142  
OBJECTO-Fragmento de taça carenada  
MATERIAL-Cerâmica  
QUADRADO-J-G7 (zona de revolvimento da câmara)  
X-  
Y-  
Z-

NºC143  
OBJECTO-Fragmento de taça carenada  
MATERIAL-Cerâmica  
QUADRADO-G8 (zona de revolvimento da câmara)  
X-  
Y-  
Z-

NºC144  
OBJECTO-Fragmento de taça semi-esférica  
MATERIAL-Cerâmica  
QUADRADO-H8 (zona de revolvimento da câmara)  
X-  
Y-  
Z-140cm

NºC145  
OBJECTO-Fragmento de taça semi-esférica  
MATERIAL-Cerâmica  
QUADRADO-H7 (zona de revolvimento da câmara)  
X-  
Y-  
Z-149cm

NºC146  
OBJECTO-Fragmento de taça semi-esférica  
MATERIAL-Cerâmica  
QUADRADO-I7  
X-40cm  
Y-190cm  
Z-141cm

NºC148  
OBJECTO-Fragmento de taça semi-esférica  
MATERIAL-Cerâmica  
QUADRADO-G7 (zona de revolvimento da câmara)  
Y-  
Z-

NºC149  
OBJECTO-Fragmento de taça semi-esférica com decoração  
MATERIAL-Cerâmica  
QUADRADO-G7 (zona de revolvimento da câmara)  
X-  
Y-  
Z-138cm

N9C150  
OBJETO-Fragmento de taça semi-esférica  
MATERIAL-Cerâmica  
QUADRADO-H7 (zona de revolvimento da câmara)  
X-  
Y-  
Z-

N9C151  
OBJETO-Fragmento de taça semi-esférica  
MATERIAL-Cerâmica  
QUADRADO-H7 (zona de revolvimento da câmara)  
X-  
Y-  
Z-149cm

N9C152  
OBJETO-Fragmento de taça semi-esférica com mamilos  
MATERIAL-Cerâmica  
QUADRADO-G7 (zona de revolvimento da câmara)  
X-  
Y-  
Z-

N9C153  
OBJETO-Fragmento de taça semi-esférica  
MATERIAL-Cerâmica  
QUADRADO-G7 (zona de revolvimento da câmara)  
X-  
Y-  
Z-

N9C154  
OBJETO-Fragmento de taça semi-esférica  
MATERIAL-Cerâmica  
QUADRADO-H8 (zona de revolvimento da câmara)  
X-  
Y-  
Z-134cm

N9C155  
OBJETO-Fragmento de taça semi-esférica (?)  
MATERIAL-Cerâmica  
QUADRADO-H8 (zona de revolvimento da câmara)  
X-  
Y-  
Z-

N9C156  
OBJETO-Fragmento de taça semi-esférica  
MATERIAL-Cerâmica  
QUADRADO-H8 (zona de revolvimento da câmara)  
X-20cm  
Y-20cm  
Z-139cm

N9C157  
OBJETO-Fragmento de taça semi-esférica  
MATERIAL-Cerâmica  
QUADRADO-H8 (zona de revolvimento da câmara)  
X-  
Y-  
Z-

N9C158  
OBJETO-Fragmento de taça (?)  
MATERIAL-Cerâmica  
QUADRADO-H7 (zona de revolvimento da câmara)  
X-  
Y-  
Z-

N9C160  
OBJETO-Fragmento de taça semi-esférica (?)  
MATERIAL-Cerâmica  
QUADRADO-G8 (zona de revolvimento da câmara)  
X-  
Y-  
Z-

N9C161  
OBJETO-Fragmento de taça  
MATERIAL-Cerâmica  
QUADRADO-H8  
X-70cm  
Y-100cm  
Z-100cm

N9C163  
OBJETO-Fragmento de elemento de mó (movente)  
MATERIAL-Granito  
QUADRADO-? (zona de revolvimento na câmara)  
X-  
Y-  
Z-

N0C164  
OBJECTO-Fragmento de elemento de mó (movente)  
MATERIAL-Granito  
QUADRADO-H7 (zona de revolvimento da câmara)  
X-  
Y-  
Z-Superfície

N0C165  
OBJECTO-Fragmento de elemento de mó (movente)  
MATERIAL-Granito  
QUADRADO-G7 (zona de revolvimento da câmara)  
X-  
Y-  
Z-

N0C166  
OBJECTO-Fragmento de elemento de mó (movente)  
MATERIAL-Granito  
QUADRADO-G7 (zona de revolvimento da câmara)  
X-  
Y-  
Z-

N0C168  
OBJECTO-Fragmento de elemento de mó (movente)  
MATERIAL-Granito  
QUADRADO-J7 (corredor)  
X-150cm  
Y-175cm  
Z-156cm

N0C169  
OBJECTO-Fragmento de elemento de mó (movente)  
MATERIAL-Granito  
QUADRADO-J7  
X-25cm  
Y-100cm  
Z-137cm

N0C170  
OBJECTO-Tampa do silo (?)  
MATERIAL-Xisto ardosiano  
QUADRADO-I7 (corredor)  
X-32cm  
Y-98cm  
Z-140cm

N0C171  
OBJECTO-Fragmento de taça  
MATERIAL-Cerâmica  
QUADRADO-J7 (Zona de revolvimento do corredor)  
X-150cm  
Y-125cm  
Z-156cm

N0C172  
OBJECTO-Fragmento de taça semi-esférica  
MATERIAL-Cerâmica  
QUADRADO-J7 (Corredor)  
X-130cm  
Y-170cm  
Z-156cm

N0C173  
OBJECTO-Fragmento de taça semi-esférica  
MATERIAL-Cerâmica  
QUADRADO-J7 (Corredor)  
X-150cm  
Y-40cm  
Z-163cm

N0C174  
OBJECTO-Fragmento de taça semi-esférica  
MATERIAL-Cerâmica  
QUADRADO-J7 (zona de revolvimento do corredor)  
X-  
Y-  
Z-

N0C176  
OBJECTO-Fragmento de taça semi-esférica  
MATERIAL-Cerâmica  
QUADRADO-J7 (zona de revolvimento do corredor)  
X-  
Y-  
Z-

N0C178  
OBJECTO-Fragmento de taça semi-esférica  
MATERIAL-Cerâmica  
QUADRADO-I7 (zona de revolvimento do corredor)  
X-  
Y-  
Z-

N9C179  
OBJETO-Fragmento de taça semi-esférica  
MATERIAL-Cerâmica  
QUADRADO-I7 (zona de revolvimento do corredor)  
X-  
Y-  
Z-

N9C180  
OBJETO-Fragmento de taça semi-esférica (?)  
MATERIAL-Cerâmica  
QUADRADO-I7 (zona de revolvimento do corredor)  
X-  
Y-  
Z-

N9C181  
OBJETO-Fragmento de taça semi-esférica  
MATERIAL-Cerâmica  
QUADRADO-I7 (zona de revolvimento do corredor)  
X-  
Y-  
Z-

N9C183  
OBJETO-Fragmento de taça esférica (?)  
MATERIAL-Cerâmica  
QUADRADO-J7  
X-120cm  
Y-130cm  
Z-160cm

N9C189  
OBJETO-Fragmento de taça semi esférica  
MATERIAL-Cerâmica  
QUADRADO-L7 (mamoa)  
X-90cm  
Y-110cm  
Z-160cm

N9C191  
OBJETO-Fragmento de vaso esférico (?)  
MATERIAL-Cerâmica  
QUADRADO-M8 (mamoa)  
X-140cm  
Y-20cm  
Z-166cm

41

N9C192  
OBJETO-Fragmento de taça esférica (?)  
MATERIAL-Cerâmica  
QUADRADO-M8 (mamoa)  
X-  
Y-  
Z-Superfície

N9C196  
OBJETO-Fragmento de taça semi-esférica  
MATERIAL-Cerâmica  
QUADRADO-? (mamoa)  
X-  
Y-  
Z-165cm

N9C198  
OBJETO-Fragmento de taça semi-esférica  
MATERIAL-Cerâmica  
QUADRADO-G6 (mamoa)  
X-180cm  
Y-36cm  
Z-121cm

N9C202  
OBJETO-Fragmento de taça semi-esférica  
MATERIAL-Cerâmica  
QUADRADO-L7 (mamoa)  
X-100cm  
Y-150cm  
Z-152cm

N9C205  
OBJETO-Fragmento de taça semi-esférica  
MATERIAL-Cerâmica  
QUADRADO-M8 (mamoa)  
X-140cm  
Y-20cm  
Z-166cm

N9C206  
OBJETO-Fragmento de taça semi-esférica  
MATERIAL-Cerâmica  
QUADRADO-? (mamoa)  
X-  
Y-  
Z-Superfície

41

N9C207  
OBJECTO-Fragmento de taça semi-esférica  
MATERIAL-Cerâmica  
QUADRADO-15 (mamao)  
X-5cm  
Y-90cm  
Z-150cm

N9C208  
OBJECTO-Fragmento de taça semi-esférica  
MATERIAL-Cerâmica  
QUADRADO-16 (mamao)  
X-5cm  
Y-90cm  
Z-156cm

N9C212  
OBJECTO-Fragmento de taça semi-esférica (?)  
MATERIAL-Cerâmica  
QUADRADO-? (mamao)  
X-  
Y-  
Z-Superfície

N9C214  
OBJECTO-Fragmento de taça semi-esférica  
MATERIAL-Cerâmica  
QUADRADO-? (mamao)  
X-  
Y-  
Z-Superfície

N9C215  
OBJECTO-Fragmento de taça semi-esférica  
MATERIAL-Cerâmica  
QUADRADO-L7  
X-19cm  
Y-190cm  
Z-161cm

N9C217  
OBJECTO-Fragmento de taça semi esférica (?)  
MATERIAL-Cerâmica  
QUADRADO-M8 (mamao)  
X-  
Y-  
Z-Superfície

N9C221  
OBJECTO-Fragmento de taça semi-esférica  
MATERIAL-Cerâmica  
QUADRADO-? (mamao)  
X-  
Y-  
Z-Superfície

N9C222  
OBJECTO-Fragmento de taça semi-esférica  
MATERIAL-Cerâmica  
QUADRADO-? (mamao)  
X-  
Y-  
Z-Superfície

N9C223  
OBJECTO-Fragmento de prato  
MATERIAL-Cerâmica  
QUADRADO-M8 (mamao)  
X-80cm  
Y-110cm  
Z-Superfície

N9C224  
OBJECTO-Fragmento de taça semi-esférica  
MATERIAL-Cerâmica  
QUADRADO-L6 (mamao)  
X-  
Y-  
Z-  
(crivo)

N9C226  
OBJECTO-Fragmento de taça semi-esférica  
MATERIAL-Cerâmica  
QUADRADO-L7 (mamao)  
X-100cm  
Y-130cm  
Z-159cm

N9C228  
OBJECTO-Fragmento de taça semi-esférica  
MATERIAL-Cerâmica  
QUADRADO-L7 (mamao)  
X-  
Y-  
Z-164cm



NGC229  
OBJETO-Fragmento de taça semi-esférica  
MATERIAL-Cerâmica  
QUADRADO-I5 (mamoá)  
X-10cm  
Y-110cm  
Z-160cm

NGC230  
OBJETO-Fragmento de taça semi-esférica  
MATERIAL-Cerâmica (mamoá)  
QUADRADO-I5  
X-10cm  
Y-110cm  
Z-160cm

NGC235  
OBJETO-Fragmento de taça semi-esférica  
MATERIAL-Cerâmica  
QUADRADO-? (mamoá)  
X-  
Y-  
Z-Superfície

NGC237  
OBJETO-Fragmento de peso de tear (?)  
MATERIAL-Cerâmica  
QUADRADO-M8 (mamoá)  
X-28cm  
Y-65cm  
Z-150cm

NGC240  
OBJETO-Perçutor  
MATERIAL-Quartzito filoniano  
QUADRADO-? (mamoá)  
X-  
Y-  
Z-Superfície

NGC241  
OBJETO-Fragmento de elemento de mó (movente)  
MATERIAL-Granito  
QUADRADO-L7  
X-  
Y-  
Z-Superfície

NGC242  
OBJETO-Fragmento de elemento de mó (movente)  
MATERIAL-Granito  
QUADRADO-L7  
X-  
Y-  
Z-Superfície

NGC243  
OBJETO-Calha rolado  
MATERIAL-Quartzito  
QUADRADO-H7 (câmara-interior do silo ?)  
X-28cm  
Y-200cm  
Z-170cm

NGC244  
OBJETO-Fragmento de elemento de mó (dormente)  
MATERIAL-Granito  
QUADRADO-? (muro de divisão de propriedade)  
X-  
Y-  
Z-

NGC245  
OBJETO-Fragmento de elemento de mó (dormente)  
MATERIAL-Granito  
QUADRADO-? (muro de divisão de propriedade)  
X-  
Y-  
Z-

NGC246  
OBJETO-Fragmento de elemento de mó (dormente)  
MATERIAL-Granito  
QUADRADO-? (muro de divisão de propriedade)  
X-  
Y-  
Z-

NGC247  
OBJETO-Fragmento de elemento de mó (dormente)  
MATERIAL-Granito  
QUADRADO-? (muro de divisão de propriedade)  
X-  
Y-  
Z-

N9C248  
OBJECTO-Fragmento de elemento de mó (dormente)  
MATERIAL-Granito  
QUADRADO-? (muro de divisão de propriedade)  
X-  
Y-  
Z-

N9C249  
OBJECTO-Fragmento de elemento de mó (dormente)  
MATERIAL-Granito  
QUADRADO-? (muro de divisão de propriedade)  
X-  
Y-  
Z-

N9C250  
OBJECTO-Fragmento de elemento de mó (dormente)  
MATERIAL-Granito  
QUADRADO-? (muro de divisão de propriedade)  
X-  
Y-  
Z-

N9C251  
OBJECTO-Fragmento de elemento de mó (dormente)  
MATERIAL-Granito  
QUADRADO-? (muro de divisão de propriedade)  
X-  
Y-  
Z-

N9C252  
OBJECTO-Fragmento de elemento de mó (dormente)  
MATERIAL-Granito  
QUADRADO-? (muro de divisão de propriedade)  
X-  
Y-  
Z-

N9C253  
OBJECTO-Fragmento de elemento de mó (dormente)  
MATERIAL-Granito  
QUADRADO-? (muro de divisão de propriedade)  
X-  
Y-  
Z-

N9C254  
OBJECTO-Fragmento de elemento de mó (dormente)  
MATERIAL-Granito  
QUADRADO-? (muro de divisão de propriedade)  
X-  
Y-  
Z-

N9C255  
OBJECTO-Fragmento de elemento de mó (dormente)  
MATERIAL-Granito  
QUADRADO-? (muro de divisão de propriedade)  
X-  
Y-  
Z-

N9C256  
OBJECTO-Fragmento de elemento de mó (dormente)  
MATERIAL-Granito  
QUADRADO-? (muro de divisão de propriedade)  
X-  
Y-  
Z-

N9C257  
OBJECTO-Fragmento de elemento de mó (dormente)  
MATERIAL-Granito  
QUADRADO-? (muro de divisão de propriedade)  
X-  
Y-  
Z-

N9C258  
OBJECTO-Fragmento de elemento de mó (dormente)  
MATERIAL-Granito  
QUADRADO-? (muro de divisão de propriedade)  
X-  
Y-  
Z-

N9  
OBJECTO-  
MATERIAL-  
QUADRADO-  
X-  
Y-  
Z-



ANTA  
das  
**CASTELHANAS**



ANTA DAS CASTELHANAS

NºAC1  
OBJECTO-Ponta de seta  
MATERIAL-Quartzo filoniano  
QUADRADO-G9  
X-60cm  
Y-60cm  
Z-301cm

NºAC2  
OBJECTO-Ponta de seta  
MATERIAL-Silex  
QUADRADO-(Câmara)  
X-  
Y-  
Z-300cm

NºAC3  
OBJECTO-Ponta de seta  
MATERIAL-Xisto ardosiario  
QUADRADO-(Corredor)  
X-  
Y-  
Z-301cm

NºAC4  
OBJECTO-Ponta de seta  
MATERIAL-Xisto ardosiario  
QUADRADO-(Corredor)  
X-  
Y-  
Z-301cm

NºAC5  
OBJECTO-Ponta de seta  
MATERIAL-Silex  
QUADRADO-F8  
X-60cm  
Y-185cm  
Z-250cm

NºAC6  
OBJECTO-Ponta de seta  
MATERIAL-Xisto ardosiario  
QUADRADO-G9  
X-120cm  
Y-50cm  
Z-300cm

NºAC7  
OBJECTO-Ponta de seta  
MATERIAL-Silex  
QUADRADO-F9  
X-100cm  
Y-130cm  
Z-272cm

NºAC8  
OBJECTO-Ponta de seta  
MATERIAL-Quartzo hialino  
QUADRADO-G8  
X-50cm  
Y-150cm  
Z-273cm

NºAC9  
OBJECTO-Ponta de seta  
MATERIAL-Xisto ardosiario  
QUADRADO-G8  
X-130cm  
Y-40cm  
Z-289cm

NºAC10  
OBJECTO-Ponta de seta  
MATERIAL-Xisto ardosiario  
QUADRADO-G8  
X-  
Y-  
Z-301cm

NºAC11  
OBJECTO-Ponta de seta  
MATERIAL-Silex  
QUADRADO-G8  
X-50cm  
Y-100cm  
Z-277cm

NºAC12  
OBJECTO-Ponta de seta  
MATERIAL-Quartzo hialino  
QUADRADO-G9  
X-8cm  
Y-60cm  
Z-289cm



N9AC25  
OBJECTO-Ponta de seta  
MATERIAL-Xisto ardosiario  
QUADRADO-F8  
X-97cm  
Y-170cm  
Z-277cm

N9AC26  
OBJECTO-Ponta de seta  
MATERIAL-Quartzo filoniano  
QUADRADO-F8  
X-  
Y-  
Z-232cm

N9AC27  
OBJECTO-Ponta de seta  
MATERIAL-Xisto ardosiario  
QUADRADO-F8  
X-115cm  
Y-105cm  
Z-264cm

N9AC28  
OBJECTO-Ponta de seta  
MATERIAL-Silex  
QUADRADO-F9  
X-96cm  
Y-140cm  
Z-300cm

N9AC29  
OBJECTO-Ponta de seta  
MATERIAL-Xisto ardosisno  
QUADRADO-G8  
X-60cm  
Y-40cm  
Z-260cm

N9AC30  
OBJECTO-Ponta de seta  
MATERIAL-Silex  
QUADRADO-F8  
X-140cm  
Y-75cm  
Z-264cm

N9AC31  
OBJECTO-Ponta de seta  
MATERIAL-Silex  
QUADRADO-G8  
X-15cm  
Y-53cm  
Z-277cm

N9AC32  
OBJECTO-Ponta de seta  
MATERIAL-Silex  
QUADRADO-G8  
X-  
Y-  
Z-272cm

N9AC33  
OBJECTO-Ponta de seta  
MATERIAL-Silex  
QUADRADO-G8  
X-  
Y-  
Z-273cm

N9AC34  
OBJECTO-Ponta de seta  
MATERIAL-Silex  
QUADRADO-(Cámara)  
X-  
Y-  
Z-290cm

N9AC35  
OBJECTO-Ponta de seta  
MATERIAL-Silex  
QUADRADO-F8  
X-190cm  
Y-170cm  
Z-301cm

N9AC36  
OBJECTO-Ponta de seta  
MATERIAL-Xisto ardosiario  
QUADRADO-F9  
X-50cm  
Y-140cm  
Z-281cm



NGAC37  
OBJECTO-Ponta de seta  
MATERIAL-Xisto ardosiano  
QUADRADO-G8  
X-  
Y-  
Z-289cm

NGAC38  
OBJECTO-Ponta de seta  
MATERIAL-Silex  
QUADRADO-F9  
X-60cm  
Y-140cm  
Z-290cm

NGAC39  
OBJECTO-Ponta de seta  
MATERIAL-Quartzo filoniano  
QUADRADO-G8  
X-30cm  
Y-60cm  
Z-277cm

NGAC40  
OBJECTO-Ponta de seta  
MATERIAL-Silex  
QUADRADO-F8  
X-180cm  
Y-180cm  
Z-301cm

NGAC41  
OBJECTO-Ponta de seta  
MATERIAL-Xisto ardosiano  
QUADRADO-G9  
X-71cm  
Y-200cm  
Z-250cm

NGAC42  
OBJECTO-Ponta de seta  
MATERIAL-Xisto ardosiano  
QUADRADO-G7  
X-180cm  
Y-60cm  
Z-300cm

NGAC43  
OBJECTO-Ponta de seta  
MATERIAL-Xisto ardosiano  
QUADRADO-G9  
X-93cm  
Y-45cm  
Z-301cm

NGAC44  
OBJECTO-Ponta de seta  
MATERIAL-Xisto ardosiano  
QUADRADO-G8  
X-0cm  
Y-80cm  
Z-290cm

NGAC45  
OBJECTO-Ponta de seta  
MATERIAL-Silex  
QUADRADO-G9  
X-  
Y-  
Z-260cm

NGAC46  
OBJECTO-Ponta de seta  
MATERIAL-Quartzo filoniano  
QUADRADO-F8  
X-90cm  
Y-155cm  
Z-277cm

NGAC47  
OBJECTO-Ponta de seta  
MATERIAL-Quartzo hialino  
QUADRADO-G9  
X-63cm  
Y-65cm  
Z-260cm

NGAC48  
OBJECTO-Fragmento de ponta de seta  
MATERIAL-Silex  
QUADRADO-F9  
X-35cm  
Y-169cm  
Z-277cm

NºAC49  
OBJECTO-Ponta de seta  
MATERIAL-Xisto ardosiario  
QUADRADO-F8  
X-  
Y-  
Z-232cm

NºAC50  
OBJECTO-Ponta de seta  
MATERIAL-Sílex  
QUADRADO-F9  
X-115cm  
Y-146cm  
Z-280cm

NºAC51  
OBJECTO-Ponta de seta  
MATERIAL-Xisto ardosiario  
QUADRADO-G8  
X-  
Y-  
Z-277cm

NºAC52  
OBJECTO-Ponta de seta  
MATERIAL-Xisto ardosiario  
QUADRADO-G8  
X-35cm  
Y-135cm  
Z-277cm

NºAC53  
OBJECTO-Ponta de seta fragmentada  
MATERIAL-Sílex  
QUADRADO-G8  
X-140cm  
Y-110cm  
Z-264cm

NºAC54  
OBJECTO-Ponta de seta  
MATERIAL-Sílex  
QUADRADO-G9  
X-105cm  
Y-40cm  
Z-290cm

NºAC55  
OBJECTO-Ponta de seta  
MATERIAL-Sílex  
QUADRADO-G8  
X-  
Y-  
Z-232cm

NºAC56  
OBJECTO-Fragmento de lámina  
MATERIAL-Sílex  
QUADRADO-F8  
X-70cm  
Y-180cm  
Z-277cm

NºAC57  
OBJECTO-Fragmento de lámina  
MATERIAL-Sílex  
QUADRADO-F8  
X-20cm  
Y-160cm  
Z-264cm

NºAC58  
OBJECTO-Fragmento de lámina  
MATERIAL-Sílex  
QUADRADO-F8  
X-20cm  
Y-60cm  
Z-255cm

NºAC59  
OBJECTO-Fragmento de ídolo-placa  
MATERIAL-Grés  
QUADRADO-G8  
X-110cm  
Y-120cm  
Z-249cm

NºAC60  
OBJECTO-Fragmento de ídolo-placa  
MATERIAL-Xisto ardosiario  
QUADRADO-G8  
X-180cm  
Y-155cm  
Z-289cm

N9AC61  
OBJECTO-Fragmento de idolo-placa  
MATERIAL-Xisto ardosiano  
QUADRADO-G8  
X-200cm  
Y-50cm  
Z-289cm

N9AC62  
OBJECTO-Fragmento de idolo-placa  
MATERIAL-Xisto ardosiano  
QUADRADO-G8  
X-140cm  
Y-55cm  
Z-284cm

N9AC63  
OBJECTO-Fragmento de idolo-placa  
MATERIAL-Xisto ardosiano  
QUADRADO-G8  
X-105cm  
Y-80cm  
Z-257cm

N9AC64  
OBJECTO-Geométrico  
MATERIAL-Silex  
QUADRADO-G9  
X-15cm  
Y-35cm  
Z-301cm

N9AC65  
OBJECTO-Calhau rolado  
MATERIAL-Quartzito  
QUADRADO-G9  
X-160cm  
Y-60cm  
Z-182cm

N9AC66  
OBJECTO-Fragmento de bordo  
MATERIAL-Cerâmica  
QUADRADO-F8  
X-70cm  
Y-160cm  
Z-277cm

N9AC67  
OBJECTO-Fragmento de bordo  
MATERIAL-Cerâmica  
QUADRADO-F8  
X-5cm  
Y-160cm  
Z-232cm

N9AC68  
OBJECTO-Taça semi-esférica fragmentada  
MATERIAL-Cerâmica  
QUADRADO-G8  
X-198cm  
Y-20cm  
Z-289cm

N9AC69  
OBJECTO-Taça semi-esférica fragmentada  
MATERIAL-Cerâmica  
QUADRADO-F8  
X-40cm  
Y-90cm  
Z-301cm

N9AC73  
OBJECTO-Fragmento de taça semi-esférica  
MATERIAL-Cerâmica  
QUADRADO-F9  
X-40cm  
Y-140cm  
Z-300cm

N9AC74  
OBJECTO-Fragmento de taça semi-esférica  
MATERIAL-Cerâmica  
QUADRADO-G9  
X-20cm  
Y-48cm  
Z-301cm

N9AC76  
OBJECTO-Taça semi-esférica fragmentada  
MATERIAL-Cerâmica  
QUADRADO-G9  
X-110cm  
Y-5cm  
Z-281cm

NºAC78  
 OBJECTO-Fragmento de bordo  
 MATERIAL-Cerâmica  
 QUADRADO-G8  
 X-50cm  
 Y-100cm  
 Z-277cm

NºAC79  
 OBJECTO-Taça semi-esférica fragmentada  
 MATERIAL-Cerâmica  
 QUADRADO-G8  
 X-177cm  
 Y-157cm  
 Z-228cm

NºAC82  
 OBJECTO-Fragmento de bordo de taça semi-esférica  
 MATERIAL-Cerâmica  
 QUADRADO-F8  
 X-10cm  
 Y-160cm  
 Z-258cm

NºAC94  
 OBJECTO-Fragmento de bordo de taça semi-esférica  
 MATERIAL-Cerâmica  
 QUADRADO-F5  
 X-10cm  
 Y-100cm  
 Z-235cm

NºAC86  
 OBJECTO-Taça carenada fragmentada com mamilos  
 MATERIAL-Cerâmica  
 QUADRADO-F9  
 X-35cm  
 Y-200cm  
 Z-280cm

NºAC87  
 OBJECTO-Taça carenada fragmentada  
 MATERIAL-Cerâmica  
 QUADRADO-G8  
 X-75cm  
 Y-125cm  
 Z-249cm

NºAC88  
 OBJECTO-Taça semi-esférica fragmentada  
 MATERIAL-Cerâmica  
 QUADRADO-G8  
 X-160cm  
 Y-95cm  
 Z-272cm

NºAC89  
 OBJECTO-Fragmento de taça semi-esférica  
 MATERIAL-Cerâmica  
 QUADRADO-F8  
 X-110cm  
 Y-120cm  
 Z-300cm

NºAC90  
 OBJECTO-Taça semi-esférica fragmentada  
 MATERIAL-Cerâmica  
 QUADRADO-G8  
 X-60cm  
 Y-115cm  
 Z-277cm

NºAC93  
 OBJECTO-Taça acampanada fragmentada  
 MATERIAL-Cerâmica  
 QUADRADO-G8  
 X-150cm  
 Y-40cm  
 Z-272cm

NºAC94  
 OBJECTO-Taça acampanada com mamilos  
 MATERIAL-Cerâmica  
 QUADRADO-G9  
 X-60cm  
 Y-30cm  
 Z-294cm

NºAC86  
 OBJECTO-Pendente  
 MATERIAL-Rocha verde  
 QUADRADO-F8  
 X-  
 Y-  
 Z-269cm

NEAC97  
OBJECTO-Pendiente  
MATERIAL-Rocha verde  
QUADRADO-G8  
X-  
Y-  
Z-273cm

NEAC98  
OBJECTO-Pendiente  
MATERIAL-Xisto ardosiario  
QUADRADO-G8  
X-80cm  
Y-180cm  
Z-273cm

NEAC99  
OBJECTO-Conta de colar  
MATERIAL-Xisto ardosiario  
QUADRADO-G8  
X-180cm  
Y-160cm  
Z-277cm

NEAC100  
OBJECTO-Conta de colar  
MATERIAL-Xisto ardosiario  
QUADRADO-F8  
X-35cm  
Y-170cm  
Z-277cm

NEAC101  
OBJECTO-Conta de colar  
MATERIAL-Xisto ardosiario  
QUADRADO-G9  
X-10cm  
Y-70cm  
Z-30cm

NEAC102  
OBJECTO-Conta de colar  
MATERIAL-Xisto ardosiario  
QUADRADO-(Cámara)  
X-  
Y-  
Z-290cm

NEAC103  
OBJECTO-Conta de colar  
MATERIAL-Xisto ardosiario  
QUADRADO-(Cámara)  
X-  
Y-  
Z-274cm

NEAC104  
OBJECTO-Conta de colar  
MATERIAL-Xisto ardosiario  
QUADRADO-F8  
X-  
Y-  
Z-250cm

NE  
OBJECTO-  
MATERIAL-  
QUADRADO-  
X-  
Y-  
Z-

NE  
OBJECTO-  
MATERIAL-  
QUADRADO-  
X-  
Y-  
Z-

NE  
OBJECTO-  
MATERIAL-  
QUADRADO-  
X-  
Y-  
Z-

NE  
OBJECTO-  
MATERIAL-  
QUADRADO-  
X-  
Y-  
Z-

ANTA  
da  
**FIGUEIRA BRANCA**



ANTA DA FIGUEIRA BRANCA

NºFB1  
 OBJECTO-Machado  
 MATERIAL-Xisto  
 QUADRADO-  
 X-  
 Y-  
 Z-  
 Superficie-mamoa

NºFB2  
 OBJECTO-Machado  
 MATERIAL-Anfibolite  
 QUADRADO-L11  
 X-102cm  
 Y-28cm  
 Z-98,80m

NºFB3  
 OBJECTO-Machado  
 MATERIAL-Anfibolite  
 QUADRADO-N10  
 X-161cm  
 Y-160cm  
 Z-99,12m

NºFB4  
 OBJECTO-Fragmento de lâmina  
 MATERIAL-Silex  
 QUADRADO-  
 X-  
 Y-  
 Z-  
 Revolvimento-Câmara

NºFB5  
 OBJECTO-Lâmina  
 MATERIAL-Silex  
 QUADRADO-  
 X-  
 Y-  
 Z-  
 Revolvimento de superficie (câmara)

NºFB6  
 OBJECTO-Ponta de seta  
 MATERIAL-Silex  
 QUADRADO-M10  
 X-88cm  
 Y-66cm  
 Z-99,37m

NºFB7  
 OBJECTO-Fragmento de ponta de seta  
 MATERIAL-Silex  
 QUADRADO-N10  
 X-26cm  
 Y-75cm  
 Z-99,26m

NºFB8  
 OBJECTO-Conta de colar  
 MATERIAL-Xisto  
 QUADRADO-  
 X-  
 Y-  
 Z-  
 Crivo-câmara

NºFB9  
 OBJECTO-Idolo-placa  
 MATERIAL-Xisto  
 QUADRADO-L10  
 X-180cm  
 Y-90cm  
 Z-99,47m

NºFB10  
 OBJECTO-Fragmento de taça  
 MATERIAL-Cerâmica  
 QUADRADO-O10  
 X-  
 Y-  
 Z-  
 Crivo

NºFB11  
 OBJECTO-Fragmento de taça semi-esférica (?)  
 MATERIAL-Cerâmica  
 QUADRADO-M10  
 X-  
 Y-  
 Z-98,90m

NºFB12  
 OBJECTO-Fragmento de taça semi-esférica  
 MATERIAL-Cerâmica  
 QUADRADO-M10  
 X-  
 Y-  
 Z-98,90m



NºFB14  
OBJETO-Fragmento de prato (?)  
MATERIAL-Cerâmica  
QUADRADO-M10  
X-110cm  
Y-60cm  
Z-99,80m

NºFB16  
OBJETO-Fragmento de taça carenada (?)  
MATERIAL-Cerâmica  
QUADRADO-M10  
X-  
Y-  
Z-  
Crivo

NºFB17  
OBJETO-Fragmento de vaso esférico  
MATERIAL-Cerâmica  
QUADRADO-M10  
X-  
Y-  
Z-99,70m

NºFB18  
OBJETO-Fragmento de taça  
MATERIAL-Cerâmica  
QUADRADO-M11  
X-40cm  
Y-11cm  
Z-99,67m

NºFB19  
OBJETO-Fragmento de taça  
MATERIAL-Cerâmica  
QUADRADO-M11  
X-134cm  
Y-100cm  
Z-99,47m

NºFB20  
OBJETO-Fragmento de taça  
MATERIAL-Cerâmica  
QUADRADO-M11  
X-134cm  
Y-100cm  
Z-99,47m

NºFB23  
OBJETO-Fragmento de taça  
MATERIAL-Cerâmica  
QUADRADO-P10  
X-  
Y-  
Z-  
Superfície

NºFB24  
OBJETO-Fragmento de taça  
MATERIAL-Cerâmica  
QUADRADO-M9  
X-  
Y-  
Z-  
Crivo

NºFB25  
OBJETO-Fragmento de taça  
MATERIAL-Cerâmica  
QUADRADO-N10  
X-29cm  
Y-134cm  
Z-99,06m

NºFB26  
OBJETO-Fragmento de taça carenada  
MATERIAL-Cerâmica  
QUADRADO-N10  
X-12cm  
Y-163cm  
Z-99,01m

NºFB27  
OBJETO-Fragmento de taça  
MATERIAL-Cerâmica  
QUADRADO-N10  
X-12cm  
Y-163cm  
Z-99,01m

NºFB28  
OBJETO-Fragmento de vaso esférico (?)  
MATERIAL-Cerâmica  
QUADRADO-N10  
X-12cm  
Y-163cm  
Z-99,01m

NºFB29  
 OBJECTO-Fragmento de taça (?)  
 MATERIAL-Cerâmica  
 QUADRADO-N10  
 X-30cm  
 Y-152cm  
 Z-89,25m

NºFB30  
 OBJECTO-  
 MATERIAL-Cerâmica  
 QUADRADO-N11  
 X-  
 Y-  
 Z-  
 Superfície

NºFB31  
 OBJECTO-Fragmento de taça  
 MATERIAL-Cerâmica  
 QUADRADO-M10  
 X-78cm  
 Y-86cm  
 Z-88,91m

NºFB32  
 OBJECTO-Fragmento de vaso esférico  
 MATERIAL-Cerâmica  
 QUADRADO-L10  
 X-  
 Y-  
 Z-  
 Crivo-Câmara

NºFB33  
 OBJECTO-Fragmento de Vaso esférico  
 MATERIAL-Cerâmica  
 QUADRADO-L10  
 X-  
 Y-  
 Z-  
 Crivo

NºFB34  
 OBJECTO-  
 MATERIAL-Cerâmica  
 QUADRADO-M10  
 X-75cm  
 Y-100cm  
 Z-88,60m  
 Violação-câmara

NºFB35  
 OBJECTO-fragmento de taça  
 MATERIAL-Cerâmica  
 QUADRADO-P10  
 X-14cm  
 Y-58cm  
 Z-Superfície

NºFB37  
 OBJECTO-Fragmento de taça carenada  
 MATERIAL-Cerâmica  
 QUADRADO-N9  
 X-  
 Y-  
 Z-  
 Crivo

NºFB38  
 OBJECTO-Fragmento de taça  
 MATERIAL-M9  
 QUADRADO-  
 X-  
 Y-  
 Z-  
 Crivo-Câmara

NºFB40  
 OBJECTO-Fragmento de taça  
 MATERIAL-Cerâmica  
 QUADRADO-L11  
 X-  
 Y-  
 Z-  
 Crivo-Câmara

NºFB42  
 OBJECTO-Fragmento de vaso semi-esférico  
 MATERIAL-Cerâmica  
 QUADRADO-  
 X-  
 Y-  
 Z-Superfície-memoa

NºFB43  
 OBJECTO-Fragmento de taça carenada  
 MATERIAL-Cerâmica  
 QUADRADO-L10  
 X-  
 Y-  
 Z-  
 Revolvimento-violação da câmara

NQFB45  
OBJECTO-Fragmento de taca  
MATERIAL-Cerâmica  
QUADRADO-N9  
X-  
Y-  
Z-  
Crivo

NQFB48  
OBJECTO-Fragmento de vaso esférico  
MATERIAL-Cerâmica  
QUADRADO-L12  
X-  
Y-  
Z-Solo de base-sondagem da mamoa-junto a carvões

NQFB50  
OBJECTO-Fragmento de taca  
MATERIAL-Cerâmica  
QUADRADO-L12  
X-  
Y-  
Z-Superficie

NQFB51  
OBJECTO-Fragmento de vaso esférico  
MATERIAL-Cerâmica  
QUADRADO-N10  
X-  
Y-  
Z-  
Crivo

NQFB54  
OBJECTO-Fragmento de taca  
MATERIAL-Cerâmica  
QUADRADO-L10  
X-  
Y-  
Z-  
Crivo

NQFB64  
OBJECTO-Fragmento de vaso semi-esférico(?)  
MATERIAL-Cerâmica  
QUADRADO-N9  
X-  
Y-  
Z-Superficie

NQFB65  
OBJECTO-Fragmento de vaso esférico  
MATERIAL-Cerâmica  
QUADRADO-M10  
X-  
Y-  
Z-  
Violação-câmara

NQFB71  
OBJECTO-Fragmento de taca  
MATERIAL-Cerâmica  
QUADRADO-L10  
X-  
Y-  
Z-  
Crivo

NQFB75  
OBJECTO-Fragmento de vaso esférico  
MATERIAL-Cerâmica  
QUADRADO-M10  
X-146cm  
Y-32cm  
Z-99,22m

NQFB76  
OBJECTO-Fragmento de taca  
MATERIAL-Cerâmica  
QUADRADO-  
X-  
Y-  
Z-Superficie-mamoa

NQFB77  
OBJECTO-Fragmento de taca  
MATERIAL-Cerâmica  
QUADRADO-  
X-  
Y-  
Z-Superficie-mamoa

NQFB78  
OBJECTO-Fragmento de taca  
MATERIAL-Cerâmica  
QUADRADO-M10  
X-146cm  
Y-32cm  
Z-99,22m

NºFB79  
OBJECTO-Fragmento de vaso esférico  
MATERIAL-Cerâmica  
QUADRADO-M10  
X-146cm  
Y-32cm  
Z-99,22m

NºFB80  
OBJECTO-Fragmento de taça  
MATERIAL-Cerâmica  
QUADRADO-M10  
X-146cm  
Y-32cm  
Z-99,22m

NºFB81  
OBJECTO-Fragmento de vaso esférico  
MATERIAL-Cerâmica  
QUADRADO-L10  
X-  
Y-  
Z-

Revolvimento sob a cobertura da câmara

NºFB82  
OBJECTO-Fragmento de taça  
MATERIAL-Cerâmica  
QUADRADO-L11  
X-50cm  
Y-20cm  
Z-Superfície

NºFB83  
OBJECTO-Fragmento de taça  
MATERIAL-Cerâmica  
QUADRADO-L11  
X-  
Y-  
Z-  
Crivo

NºFB84  
OBJECTO-Fragmento de taça  
MATERIAL-Cerâmica  
QUADRADO-L11  
X-  
Y-  
Z-  
Crivo

NºFB85  
OBJECTO-Fragmento de taça  
MATERIAL-Cerâmica  
QUADRADO-M11  
X-  
Y-  
Z-

Revolvimento sob a cobertura da câmara

NºFB86  
OBJECTO-Fragmento de vaso esférico  
MATERIAL-Cerâmica  
QUADRADO-L9  
X-172cm  
Y-133cm  
Z-Superfície

NºFB87  
OBJECTO-Fragmento de vaso semi-esférico  
MATERIAL-Cerâmica  
QUADRADO-L10  
X-75cm  
Y-110cm  
Z-Superfície

NºFB88  
OBJECTO-Fragmento de taça  
MATERIAL-Cerâmica  
QUADRADO-M11  
X-84cm  
Y-44cm  
Z-99,25m

NºFB89  
OBJECTO-Fragmento de taça  
MATERIAL-Cerâmica  
QUADRADO-M11  
X-  
Y-  
Z-

Revolvimento sob a cobertura da câmara

NºFB90  
OBJECTO-Fragmento de vaso esférico  
MATERIAL-Cerâmica  
QUADRADO-M11  
X-  
Y-  
Z-

Revolvimento sob a cobertura da câmara

NOFB91  
OBJECTO-Fragmento de vaso esférico  
MATERIAL-Cerâmica  
QUADRADO-L11  
X-  
Y-  
Z-  
Revolvimento sob a cobertura da câmara

NOFB93  
OBJECTO-Fragmento de Vaso esférico  
MATERIAL-Cerâmica  
QUADRADO-L11  
X-  
Y-  
Z-  
Revolvimento sob a cobertura da câmara

NOFB94  
OBJECTO-Fragmento de vaso esférico  
MATERIAL-Cerâmica  
QUADRADO-L10  
X-75cm  
Y-110cm  
Z-Superfície

NOFB99  
OBJECTO-Fragmento de taça  
MATERIAL-Cerâmica  
QUADRADO-L11  
X-45cm  
Y-60cm  
Z-Superfície

NOFB100  
OBJECTO-Fragmento de mó (movente)  
MATERIAL-Granito  
QUADRADO-L11  
X-  
Y-  
Z-Superfície

NOFB101  
OBJECTO-Fragmento de mó (movente)  
MATERIAL-Granito  
QUADRADO-L12  
X-  
Y-  
Z-Superfície

NOFB102  
OBJECTO-Fragmento de mó (movente)  
MATERIAL-Granito  
QUADRADO-L12  
X-  
Y-  
Z-Superfície

NOFB103  
OBJECTO-Fragmento de mó (movente)  
MATERIAL-Granito  
QUADRADO-  
X-  
Y-  
Z-Superfície-mamoa

NOFB104  
OBJECTO-Fragmento de mó (movente)  
MATERIAL-Granito  
QUADRADO-M13  
X-175cm  
Y-131cm  
Z-Superfície

NOFB127  
OBJECTO-Fragmento de mó (dormente)  
MATERIAL-Granito  
QUADRADO-L10  
X-164cm  
Y-194cm  
Z-98,72m

NOFB135  
OBJECTO-Fragmento de mó (dormente)  
MATERIAL-Granito  
QUADRADO-O10  
X-100cm  
Y-120cm  
Z-99,87m  
Utilizado como calço de esteio

NOFB136  
OBJECTO-Fragmento de mó (dormente)  
MATERIAL-Granito  
QUADRADO-N11  
X-96cm  
Y-70cm  
Z-99,79m  
Utilizado como calço de esteio

NoFB137  
 OBJETO-Fragmento de mó (dormente)  
 MATERIAL-Granito  
 CUADRADO-J11  
 X-  
 Y-  
 Z-Superficie

NoFB138  
 OBJETO-Fragmento de mó (dormente)  
 MATERIAL-Granito  
 CUADRADO-J9  
 X-  
 Y-  
 Z-Superficie

NoFB139  
 OBJETO-Fragmento de mó (dormente)  
 MATERIAL-Granito  
 CUADRADO-M9  
 X-  
 Y-  
 Z-Superficie

NoFB140  
 OBJETO-Fragmento de mó (dormente)  
 MATERIAL-Granito  
 CUADRADO-M12  
 X-  
 Y-  
 Z-Superficie

NoFB141  
 OBJETO-Elemento de mó (dormente)  
 MATERIAL-Granito  
 CUADRADO-N9  
 X-  
 Y-  
 Z-Superficie

NoFB142  
 OBJETO-Fragmento de mó (dormente)  
 MATERIAL-Granito  
 CUADRADO-J11  
 X-  
 Y-  
 Z-Superficie

NoFB143  
 OBJETO-Fragmento de mó (dormente)  
 MATERIAL-Granito  
 CUADRADO-L13  
 X-  
 Y-  
 Z-Superficie

NoFB144  
 OBJETO-Fragmento de mó (dormente)  
 MATERIAL-Granito  
 CUADRADO-L9  
 X-  
 Y-  
 Z-Superficie

NoFB145  
 OBJETO-Fragmento de mó (dormente)  
 MATERIAL-Granito  
 CUADRADO-M11  
 X-  
 Y-  
 Z-Superficie

NoFB146  
 OBJETO-Fragmento de mó (dormente)  
 MATERIAL-Granito  
 CUADRADO-M11  
 X-  
 Y-  
 Z-Superficie

NoFB147  
 OBJETO-Fragmento de mó (dormente)  
 MATERIAL-Granito  
 CUADRADO-N11  
 X-  
 Y-  
 Z-Superficie

NoFB148  
 OBJETO-Fragmento de mó (dormente)  
 MATERIAL-Granito  
 CUADRADO-N11  
 X-  
 Y-  
 Z-Superficie

NQFB149  
OBJECTO-Fragmento de m6 (dormente)  
MATERIAL-Granito  
QUADRADO-J11  
X-  
Y-  
Z-Superficie

NQFB150  
OBJECTO-Fragmento de m6 (dormente)  
MATERIAL-Granito  
QUADRADO-012  
X-  
Y-  
Z-Superficie

NQFB151  
OBJECTO-Fragmento de m6 (dormente)  
MATERIAL-Granito  
QUADRADO-J9  
X-  
Y-  
Z-Superficie

NQFB152  
OBJECTO-Fragmento de m6 (dormente)  
MATERIAL-Granito  
QUADRADO-M9  
X-  
Y-  
Z-Superficie

NQFB153  
OBJECTO-Fragmento de m6 (dormente)  
MATERIAL-Granito  
QUADRADO-N12  
X-  
Y-  
Z-Superficie

NQFB154  
OBJECTO-Fragmento de m6 (dormente)  
MATERIAL-Granito  
QUADRADO-N12  
X-  
Y-  
Z-Superficie

NQFB155  
OBJECTO-Fragmento de m6 (dormente)  
MATERIAL-Granito  
QUADRADO-M10  
X-  
Y-  
Z-Superficie

NQFB156  
OBJECTO-Fragmento de m6 (dormente)  
MATERIAL-Granito  
QUADRADO-19  
X-  
Y-  
Z-Superficie

NQFB157  
OBJECTO-Fragmento de m6 (dormente)  
MATERIAL-Granito  
QUADRADO-H9  
X-  
Y-  
Z-Superficie

NQFB158  
OBJECTO-Fragmento de m6 (dormente)  
MATERIAL-Granito  
QUADRADO-M12  
X-  
Y-  
Z-Superficie

NQFB159  
OBJECTO-Fragmento de m6  
MATERIAL-Granito  
QUADRADO-M12  
X-  
Y-  
Z-Superficie

ANTA  
dos  
**POMBAIS**





ANTA DOS FOMBAIS

NoAP1	OBJECTO-Geométrico	NoAP7	OBJECTO-Geométrico
	MATERIAL-Quartzo filoniano		MATERIAL-Silex
	QUADRADO-D8		QUADRADO-E6
X-		X-	
Y-		Y-	
Z-		Z-	
Crivo		Crivo	
NoAP2	OBJECTO-Geométrico	NoAP9	OBJECTO-Resto de talhe
	MATERIAL-Silex		MATERIAL-Quartzo filoniano
	QUADRADO-D8		QUADRADO-E6
X-		X-	
Y-		Y-	
Z-		Z-	140cm
Crivo		Crivo	
NoAP3	OBJECTO-Resto de Talhe	NoAP10	OBJECTO-Resto de talhe
	MATERIAL-Silex		MATERIAL-Quartzo filoniano
	QUADRADO-F9		QUADRADO-E6
X-40cm		X-	
Y-50cm		Y-	
Z-163cm		Z-	
Crivo		Crivo	
NoAP4	OBJECTO-Resto de Talhe	NoAP11	OBJECTO-Resto de talhe
	MATERIAL-Quartzo hialino		MATERIAL-Quartzo hialino
	QUADRADO-E6		QUADRADO-
X-		X-	
Y-		Y-	
Z-140cm		Z-	
Crivo		Crivo	
NoAP5	OBJECTO-Geométrico	NoAP12	OBJECTO-Lamela
	MATERIAL-Silex		MATERIAL-Quartzo hialino
	QUADRADO-E7		QUADRADO-E6
X-20cm		X-	
Y-12cm		Y-	
Z-150cm		Z-	
Crivo		Crivo	
NoAP6	OBJECTO-Geométrico	NoAP13	OBJECTO-Resto de talhe
	MATERIAL-Silex		MATERIAL-Silex
	QUADRADO-E6		QUADRADO-E6
X-		X-	
Y-		Y-	
Z-147cm		Z-	133cm
Crivo		Crivo	

NGAP14  
OBJECTO-Núcleo  
MATERIAL-Quartzó filoniano  
QUADRADO-D6  
X-156cm  
Y-182cm  
Z-161cm

NGAP16  
OBJECTO-Lâmina  
MATERIAL-Sílex  
QUADRADO-D7  
X-20cm  
Y-000cm  
Z-144cm

NGAP17  
OBJECTO-Lâmina  
MATERIAL-Sílex  
QUADRADO-E7  
X-84cm  
Y-119cm  
Z-137cm

NGAP18  
OBJECTO-Lâmina fragmentada  
MATERIAL-Sílex  
QUADRADO-E6  
X-150cm  
Y-192cm  
Z-125cm

NGAP19  
OBJECTO-Lâmina fragmentada  
MATERIAL-Sílex  
QUADRADO-E6  
X-148cm  
Y-30cm  
Z-86cm

NGAP20  
OBJECTO-Lâmina fragmentada  
MATERIAL-Sílex  
QUADRADO-E6  
X-  
Y-  
Z-  
Crivo

NGAP21  
OBJECTO-Ponta de seta  
MATERIAL-Quartzó hialino  
QUADRADO-D6  
X-  
Y-  
Z-  
Crivo

NGAP22  
OBJECTO-Ponta de seta  
MATERIAL-Sílex  
QUADRADO-E6  
X-122cm  
Y-000cm  
Z-150cm

NGAP23  
OBJECTO-Ponta de seta  
MATERIAL-Sílex  
QUADRADO-E6  
X-9cm  
Y-2cm  
Z-139cm

NGAP24  
OBJECTO-Ponta de seta  
MATERIAL-Quartzó hialino  
QUADRADO-E6  
X-  
Y-  
Z-  
Crivo

NGAP25  
OBJECTO-Ponta de seta  
MATERIAL-Sílex  
QUADRADO-E6  
X-170cm  
Y-65cm  
Z-96cm

NGAP26  
OBJECTO-Ponta de seta  
MATERIAL-Sílex  
QUADRADO-E6  
X-  
Y-  
Z-  
Crivo

NºAP27  
OBJECTO-Ponta de seta  
MATERIAL-Quartzzo hialino  
QUADRADO-E7  
X-27cm  
Y-136cm  
Z-159cm

NºAP28  
OBJECTO-Ponta de seta  
MATERIAL-Silex  
QUADRADO-E5  
X-176cm  
Y-141cm  
Z-138cm

NºAP29  
OBJECTO-Ponta de seta  
MATERIAL-Silex  
QUADRADO-E6  
X-30cm  
Y-134cm  
Z-125cm

NºAP30  
OBJECTO-Ponta de seta  
MATERIAL-Silex  
QUADRADO-E6  
X-  
Y-  
Z-  
Crivo

NºAP31  
OBJECTO-Ponta de seta  
MATERIAL-Silex  
QUADRADO-E5  
X-186cm  
Y-182cm  
Z-143cm

NºAP32  
OBJECTO-Ponta de seta  
MATERIAL-Silex  
QUADRADO-  
X-  
Y-  
Z-  
Crivo

NºAP33  
OBJECTO-Ponta de seta  
MATERIAL-Silex  
QUADRADO-E6  
X-000cm  
Y-175cm  
Z-141cm

NºAP34  
OBJECTO-Ponta de seta  
MATERIAL-Silex  
QUADRADO-E6  
X-154cm  
Y-40cm  
Z-143cm

NºAP35  
OBJECTO-Ponta de seta  
MATERIAL-Quartzzo filoniano  
QUADRADO-D6  
X-  
Y-  
Z-  
Terra de revolvimento no interior da câmara

NºAP36  
OBJECTO-Ponta de seta  
MATERIAL-Silex  
QUADRADO-E6  
X-  
Y-  
Z-138cm  
Crivo

NºAP37  
OBJECTO-Ponta de seta  
MATERIAL-Silex  
QUADRADO-D6  
X-  
Y-  
Z-  
Crivo

NºAP38  
OBJECTO-Ponta de seta  
MATERIAL-Silex  
QUADRADO-D6  
X-  
Y-  
Z-  
Crivo

NOAP39  
OBJECTO-Ponta de seta  
MATERIAL-Quartzo filoniano  
QUADRADO-  
X-  
Y-  
Z-

Crivo-terras em revolvimento na câmara

NOAP40  
OBJECTO-Ponta de seta  
MATERIAL-Silex  
QUADRADO-D5

X-  
Y-  
Z-140cm  
Crivo

NOAP41  
OBJECTO-Ponta de seta  
MATERIAL-Silex  
QUADRADO-E6

X-35cm  
Y-30cm  
Z-133cm

NOAP42  
OBJECTO-Ponta de seta  
MATERIAL-Silex  
QUADRADO-E6

X-  
Y-  
Z-  
Crivo

NOAP43  
OBJECTO-Ponta de seta  
MATERIAL-Silex  
QUADRADO-E6

X-76cm  
Y-100cm  
Z-133cm

NOAP44  
OBJECTO-Ponta de seta  
MATERIAL-Quartzo filoniano  
QUADRADO-  
X-  
Y-  
Z-

Crivo-Terras de revolvimento na câmara

NOAP45  
OBJECTO-Ponta de seta  
MATERIAL-Quartzo hialino  
QUADRADO-E6  
X-180cm  
Y-36cm  
Z-137cm

NOAP46  
OBJECTO-Ponta de seta  
MATERIAL-Quartzo filoniano  
QUADRADO-E6  
X-14cm  
Y-112cm  
Z-139cm

NOAP47  
OBJECTO-Ponta de seta  
MATERIAL-Silex  
QUADRADO-E7  
X-81cm  
Y-79cm  
Z-129cm

NOAP48  
OBJECTO-Ponta de seta  
MATERIAL-Silex  
QUADRADO-D6  
X-170cm  
Y-185cm  
Z-143cm

NOAP49  
OBJECTO-Ponta de seta  
MATERIAL-Silex  
QUADRADO-D6  
X-  
Y-  
Z-  
Crivo

NOAP50  
OBJECTO-Ponta de seta  
MATERIAL-Quartzo filoniano  
QUADRADO-E6  
X-178cm  
Y-103cm  
Z-134cm

N9AP51  
 OBJECTO-Ponta de seta  
 MATERIAL-Silex  
 QUADRADO-E6  
 X-30cm  
 Y-109cm  
 Z-139cm

N9AP52  
 OBJECTO-Ponta de seta  
 MATERIAL-Quartzoz hialino  
 QUADRADO-D6  
 X-  
 Y-  
 Z-  
 Crivo

N9AP53  
 OBJECTO-Ponta de seta  
 MATERIAL-Quartzoz filoniano  
 QUADRADO-E5  
 X-40cm  
 Y-68cm  
 Z-144cm

N9AP54  
 OBJECTO-Conta de colar  
 MATERIAL-Xisto  
 QUADRADO-E6  
 X-  
 Y-  
 Z-  
 Crivo

N9AP55  
 OBJECTO-Conta de colar  
 MATERIAL-Xisto  
 QUADRADO-E6  
 X-  
 Y-  
 Z-125cm

N9AP56  
 OBJECTO-Conta de colar  
 MATERIAL-Xisto  
 QUADRADO-E6  
 X-  
 Y-  
 Z-  
 Crivo

N9AP57  
 OBJECTO-Conta de colar  
 MATERIAL-Xisto  
 QUADRADO-E6  
 X-14cm  
 Y-154cm  
 Z-141cm

N9AP58  
 OBJECTO-Conta de colar  
 MATERIAL-Xisto  
 QUADRADO-E6  
 X-  
 Y-  
 Z-  
 Crivo

N9AP59  
 OBJECTO-Conta de colar  
 MATERIAL-Xisto  
 QUADRADO-E6  
 X-8cm  
 Y-80cm  
 Z-130cm

N9AP60  
 OBJECTO-Conta de colar  
 MATERIAL-Xisto  
 QUADRADO-  
 X-  
 Y-  
 Z-  
 Crivo-Cámara

N9AP61  
 OBJECTO-Conta de colar  
 MATERIAL-Xisto  
 QUADRADO-E6  
 X-13cm  
 Y-38cm  
 Z-134cm

N9AP62  
 OBJECTO-Conta de colar  
 MATERIAL-Xisto  
 QUADRADO-  
 X-  
 Y-  
 Z-  
 Crivo-Cámara

NGAP63  
OBJECTO-Conta de colar  
MATERIAL-Xisto  
QUADRADO-  
X-  
Y-  
Z-141cm  
Crivo-Câmara

NGAP64  
OBJECTO-Conta de colar  
MATERIAL-Xisto  
QUADRADO-  
X-  
Y-  
Z-  
Crivo-Câmara

NGAP65  
OBJECTO-Conta de colar  
MATERIAL-Xisto  
QUADRADO-  
X-  
Y-  
Z-  
Crivo-Câmara

NGAP66  
OBJECTO-Conta de colar  
MATERIAL-Xisto  
QUADRADO-E6  
X-63cm  
Y-104cm  
Z-146cm

NGAP67  
OBJECTO-Conta de colar  
MATERIAL-Xisto  
QUADRADO-  
X-  
Y-  
Z-  
Crivo-Câmara

NGAP68  
OBJECTO-Conta de colar  
MATERIAL-Xisto  
QUADRADO-E7  
X-18cm  
Y-53cm  
Z-113cm

NGAP69  
OBJECTO-Conta de colar  
MATERIAL-Xisto  
QUADRADO-  
X-  
Y-  
Z-  
Crivo-Câmara

NGAP70  
OBJECTO-Conta de colar  
MATERIAL-Xisto  
QUADRADO-  
X-  
Y-  
Z-  
Crivo-Câmara

NGAP71  
OBJECTO-Elementos de adorno  
MATERIAL-Xisto  
QUADRADO-E6  
X-161cm  
Y-136cm  
Z-155cm

NGAP72  
OBJECTO-Conta de colar  
MATERIAL-Xisto  
QUADRADO-  
X-  
Y-  
Z-  
Crivo-Câmara

NGAP73  
OBJECTO-Conta de colar  
MATERIAL-Xisto  
QUADRADO-  
X-  
Y-  
Z-  
Crivo-Câmara

NGAP74  
OBJECTO-Conta de colar  
MATERIAL-Xisto  
QUADRADO-E5  
X-178cm  
Y-90cm  
Z-140cm

NºAP75  
OBJECTO-Conta de colar  
MATERIAL-Xisto  
QUADRADO-  
X-  
Y-  
Z-  
Crivo-Cámara

NºAP76  
OBJECTO-Conta de colar  
MATERIAL-Xisto  
QUADRADO-  
X-  
Y-  
Z-  
Crivo-Cámara

NºAP77  
OBJECTO-Conta de colar  
MATERIAL-Xisto  
QUADRADO-E6  
X-23cm  
Y-37cm  
Z-134cm

NºAP78  
OBJECTO-Conta de colar  
MATERIAL-Xisto  
QUADRADO-E6  
X-100cm  
Y-1cm  
Z-149cm

NºAP79  
OBJECTO-Conta de colar  
MATERIAL-Xisto  
QUADRADO-  
X-  
Y-  
Z-  
Crivo-Cámara

NºAP80  
OBJECTO-Conta de colar  
MATERIAL-Xisto  
QUADRADO-  
X-  
Y-  
Z-  
Crivo-Cámara

NºAP81  
OBJECTO-Conta de colar  
MATERIAL-Xisto  
QUADRADO-  
X-  
Y-  
Z-  
Crivo-Cámara

NºAP82  
OBJECTO-Conta de colar  
MATERIAL-Xisto  
QUADRADO-  
X-  
Y-  
Z-  
Crivo-Cámara

NºAP83  
OBJECTO-Conta de colar  
MATERIAL-Xisto  
QUADRADO-  
X-  
Y-  
Z-  
Crivo-Cámara

NºAP84  
OBJECTO-Conta de colar  
MATERIAL-Xisto  
QUADRADO-  
X-  
Y-  
Z-  
Crivo-Cámara

NºAP85  
OBJECTO-Conta de colar  
MATERIAL-Xisto  
QUADRADO-E6  
X-  
Y-  
Z-  
Crivo-Cámara

NºAP86  
OBJECTO-Conta de colar  
MATERIAL-Xisto  
QUADRADO-E5  
X-145cm  
Y-102cm  
Z-140cm



NOAP87  
OBJECTO-Conta de colar  
MATERIAL-Xisto  
QUADRADO-E5  
X-109cm  
Y-81cm  
Z-137cm

NOAP88  
OBJECTO-Conta de colar  
MATERIAL-Xisto  
QUADRADO-E5  
X-120cm  
Y-102cm  
Z-136cm

NOAP89  
OBJECTO-Conta de colar  
MATERIAL-Xisto  
QUADRADO-E6  
X-  
Y-  
Z-  
Crivo-Câmara

NOAP90  
OBJECTO-Conta de colar  
MATERIAL-Âmbar  
QUADRADO-E6  
X-96cm  
Y-000cm  
Z-130cm

NOAP91  
OBJECTO-Conta de colar  
MATERIAL-Âmbar  
QUADRADO-D6  
X-9cm  
Y-32cm  
Z-141cm

NOAP92  
OBJECTO-Conta de colar  
MATERIAL-Xisto  
QUADRADO-E6  
X-155cm  
Y-8cm  
Z-143cm

NOAP93  
OBJECTO-Conta de colar  
MATERIAL-Âmbar  
QUADRADO-E6  
X-  
Y-  
Z-146cm

NOAP94  
OBJECTO-Pendente  
MATERIAL-Xisto  
QUADRADO-D6  
X-  
Y-  
Z-  
Crivo

NOAP95  
OBJECTO-Pendente  
MATERIAL-"Rocha verde"  
QUADRADO-  
X-  
Y-  
Z-  
Superficie

NOAP96  
OBJECTO-Fragmento de idolo-placa  
MATERIAL-Xisto  
QUADRADO-E6  
X-150cm  
Y-85cm  
Z-114cm

NOAP97  
OBJECTO-Fragmento de idolo-placa  
MATERIAL-Xisto  
QUADRADO-E8  
X-94cm  
Y-183cm  
Z-148cm

NOAP98  
OBJECTO-Fragmento de idolo-placa  
MATERIAL-Xisto  
QUADRADO-E6  
X-56cm  
Y-49cm  
Z-146cm

NºAP99  
OBJETO-Fragmento de idolo-placa  
MATERIAL-Xisto  
QUADRADO-D6  
X-145cm  
Y-170cm  
Z-155cm

NºAP100  
OBJETO-Fragmento de idolo-placa  
MATERIAL-Xisto  
QUADRADO-D6  
X-  
Y-  
Z-  
Crivo

NºAP101  
OBJETO-Fragmento de idolo-placa  
MATERIAL-Xisto  
QUADRADO-E7  
X-26cm  
Y-100cm  
Z-153cm

NºAP102  
OBJETO-Fragmento de idolo-placa  
MATERIAL-Xisto  
QUADRADO-E7  
X-110cm  
Y-045cm  
Z-148cm

NºAP103  
OBJETO-Fragmento de idolo-placa  
MATERIAL-Xisto  
QUADRADO-E6  
X-156cm  
Y-126cm  
Z-155cm

NºAP104  
OBJETO-Fragmento de idolo-placa  
MATERIAL-Grés  
QUADRADO-E7  
X-15cm  
Y-85cm  
Z-143cm

NºAP105  
OBJETO-Fragmento de idolo-placa  
MATERIAL-Grés  
QUADRADO-E6  
X-115cm  
Y-12cm  
Z-142cm

NºAP106  
OBJETO-idolo-placa fragmentado  
MATERIAL-Grés  
QUADRADO-E6  
X-182cm  
Y-12cm  
Z-149cm

NºAP107  
OBJETO-Fragmento de idolo-placa  
MATERIAL-Grés  
QUADRADO-  
X-  
Y-  
Z-  
Crivo-Cámara

NºAP108  
OBJETO-Machado  
MATERIAL-Anfibolite  
QUADRADO-D8  
X-174cm  
Y-52cm  
Z-137cm

NºAP109  
OBJETO-Machado  
MATERIAL-Anfibolite  
QUADRADO-E6  
X-200cm  
Y-000cm  
Z-128cm

NºAP110  
OBJETO-Machado  
MATERIAL-Granito  
QUADRADO-D6  
X-40cm  
Y-136cm  
Z-140cm

NEAP111  
OBJECTO-Machado  
MATERIAL-Anfibolite  
QUADRADO-E7  
X-37cm  
Y-100cm  
Z-152cm

NEAP112  
OBJECTO-Enxó  
MATERIAL-Anfibolite  
QUADRADO-E8  
X-177cm  
Y-12cm  
Z-146cm

NEAP113  
OBJECTO-Perutor  
MATERIAL-Quartzito  
QUADRADO-E6  
X-55cm  
Y-131cm  
Z-141cm

NEAP114  
OBJECTO-Perutor  
MATERIAL-Quartzito  
QUADRADO-  
X-  
Y-  
Z-  
Superficie

NEAP115  
OBJECTO-Perutor  
MATERIAL-Quartzito  
QUADRADO-C6  
X-138cm  
Y-20cm  
Z-100cm

NEAP116  
OBJECTO-Perutor  
MATERIAL-Granito  
QUADRADO-E6  
X-  
Y-  
Z-134cm

NEAP117  
OBJECTO-Perutor  
MATERIAL-Quartzito  
QUADRADO-E5  
X-146cm  
Y-40cm  
Z-133cm

NEAP118  
OBJECTO-Perutor  
MATERIAL-Quartzito  
QUADRADO-E4  
X-126cm  
Y-11cm  
Z-82cm

NEAP119  
OBJECTO-Fragmento de elemento de mó (movente)  
MATERIAL-Granito  
QUADRADO-D6  
X-190cm  
Y-10cm  
Z-115cm

NEAP120  
OBJECTO-Fragmento de elemento de mó (movente)  
MATERIAL-Granito  
QUADRADO-E7  
X-26cm  
Y-150cm  
Z-116cm

NEAP121  
OBJECTO-Perutor  
MATERIAL-Quartzito  
QUADRADO-D4  
X-84cm  
Y-182cm  
Z-86cm

NEAP122  
OBJECTO-Perutor  
MATERIAL-Granito  
QUADRADO-E5  
X-20cm  
Y-68cm  
Z-88cm

NºAP123  
 OBJECTO-Fragmento de elemento de mó (movente)  
 MATERIAL-Granito  
 QUADRADO-  
 X-  
 Y-  
 Z-  
 (Superficie)

NºAP124  
 OBJECTO-Fragmento de elemento de mó (movente)  
 MATERIAL-Granito  
 QUADRADO-  
 X-  
 Y-  
 Z-  
 (Superficie)

NºAP125  
 OBJECTO-Fragmento de elemento de mó (movente)  
 MATERIAL-  
 QUADRADO-  
 X-  
 Y-  
 Z-  
 (Mamao-superficie)

NºAP126  
 OBJECTO-Peso de rede(?)  
 MATERIAL-Anfibolite  
 QUADRADO-D6  
 X-87cm  
 Y-65cm  
 Z-79cm

NºAP127  
 OBJECTO-Cristal  
 MATERIAL-Quartzito  
 QUADRADO-E6  
 X-  
 Y-  
 Z-  
 Crivo

NºAP128  
 OBJECTO-Calhau rolado com vestígios de ocre  
 MATERIAL-Quartzito  
 QUADRADO-E6  
 X-123cm  
 Y-600cm  
 Z-150cm

NºAP129  
 OBJECTO-Calhau rolado com vestígios de ocre  
 MATERIAL-Quartzito  
 QUADRADO-C4  
 X-  
 Y-  
 Z-  
 Crivo

NºAP130  
 OBJECTO-Calhau rolado  
 MATERIAL-Quartzito  
 QUADRADO-E8  
 X-  
 Y-  
 Z-147cm  
 Crivo

NºAP132  
 OBJECTO-Fragmento de elemento de mó (dormente)  
 MATERIAL-Granito  
 QUADRADO-D6  
 X-100cm  
 Y-160cm  
 Z-120cm

NºAP133  
 OBJECTO-Fragmento de elemento de mó (dormente)  
 MATERIAL-Granito  
 QUADRADO-  
 X-  
 Y-  
 Z-  
 (Superficie)

NºAP135  
 OBJECTO-Fragmento de ídolo-placa  
 MATERIAL-Grés  
 QUADRADO-E7  
 X-103cm  
 Y-86cm  
 Z-147cm

NºAP136  
 OBJECTO-Taça alta  
 MATERIAL-Cerâmica  
 QUADRADO-E7  
 X-126cm  
 Y-70cm  
 Z-153cm

NGAP138  
OBJECTO-Fragmento de vaso esférico  
MATERIAL-Cerâmica  
QUADRADO-E7  
X-150cm  
Y-68cm  
Z-138cm

NGAP139  
OBJECTO-Taca alta  
MATERIAL-cerâmica  
QUADRADO-E7  
X-75cm  
Y-75cm  
Z-140cm

NGAP141  
OBJECTO-Fragmento de bordo de Pote globular  
MATERIAL-Cerâmica  
QUADRADO-D7  
X-  
Y-  
Z-  
Crivo

NGAP144  
OBJECTO-Fragmento de pequeno pote com decoração  
MATERIAL-Cerâmica  
QUADRADO-D6  
X-58cm  
Y-72cm  
Z-87cm

NGAP145  
OBJECTO-Fragmento de taca  
MATERIAL-Cerâmica  
QUADRADO-E6  
X-000cm  
Y-174cm  
Z-141cm

NGAP150  
OBJECTO-Fragmento de vaso esférico  
MATERIAL-Cerâmica  
QUADRADO-E6  
X-  
Y-  
Z-  
Crivo

NGAP153  
OBJECTO-Taca de bordos rectos  
MATERIAL-Cerâmica  
QUADRADO-D6  
X-80cm  
Y-174cm  
Z-138cm

NGAP154  
OBJECTO-Fragmento de taca carenada  
MATERIAL-Cerâmica  
QUADRADO-E5  
X-178cm  
Y-167cm  
Z-140cm

NGAP158  
OBJECTO-Fragmento de taca carenada  
MATERIAL-Cerâmica  
QUADRADO-D7  
X-85cm  
Y-79cm  
Z-107cm

NGAP173  
OBJECTO-Fragmento de bordo de Pote  
MATERIAL-Cerâmica  
QUADRADO-  
X-  
Y-  
Z-  
Crivo-mamoa

NGAP174  
OBJECTO-Fragmento de bordo de taca  
MATERIAL-Cerâmica  
QUADRADO-  
X-  
Y-  
Z-  
Crivo-mamoa

NGAP175  
OBJECTO-Fragmento de bordo de taca  
MATERIAL-Cerâmica  
QUADRADO-  
X-  
Y-  
Z-  
Crivo-mamoa

NºAPI76  
OBJECTO-Fragmento de Bordo de pote(?)  
MATERIAL-Cerámica  
QUADRADO-

X-  
Y-  
Z-  
Crivo-manca

Nº  
OBJECTO-  
MATERIAL-  
QUADRADO-

X-  
Y-  
Z-

Nº  
OBJECTO-  
MATERIAL-  
QUADRADO-

X-  
Y-  
Z-

Nº  
OBJECTO-  
MATERIAL-  
QUADRADO-

X-  
Y-  
Z-

Nº  
OBJECTO-  
MATERIAL-  
QUADRADO-

X-  
Y-  
Z-

Nº  
OBJECTO-  
MATERIAL-  
QUADRADO-

X-  
Y-  
Z-



**ANTA**  
**I do ALCOGULO**





ANTA DO ALCOGULO I

NQAI1  
 OBJECTO-Taça  
 MATERIAL-Cerâmica  
 QUADRADO-(Corredor)  
 X-  
 Y-  
 Z-

NQAI2  
 OBJECTO-Taça semi-esférica  
 MATERIAL-Cerâmica  
 QUADRADO-(Corredor)  
 X-  
 Y-  
 Z-

NQAI3  
 OBJECTO-Taça  
 MATERIAL-Cerâmica  
 QUADRADO-(Corredor)  
 X-  
 Y-  
 Z-

NQAI4  
 OBJECTO-Colher  
 MATERIAL-Cerâmica  
 QUADRADO-(Corredor)  
 X-  
 Y-  
 Z-

NQAI5  
 OBJECTO-Fragmento de taça  
 MATERIAL-Cerâmica  
 QUADRADO-(Corredor)  
 X-  
 Y-  
 Z-

NQAI6  
 OBJECTO-Taça  
 MATERIAL-Cerâmica  
 QUADRADO-(Corredor)  
 X-  
 Y-  
 Z-

NQAI7  
 OBJECTO-Fragmento de taça  
 MATERIAL-Cerâmica  
 QUADRADO-(Corredor)  
 X-  
 Y-  
 Z-

NQAI8  
 OBJECTO-Fragmento de vaso  
 MATERIAL-Cerâmica  
 QUADRADO-(Corredor)  
 X-  
 Y-  
 Z-

NQAI9  
 OBJECTO-Fragmento de taça carenada  
 MATERIAL-Cerâmica  
 QUADRADO-(Corredor)  
 X-  
 Y-  
 Z-

NQAI10  
 OBJECTO-Taça semi-esférica  
 MATERIAL-Cerâmica  
 QUADRADO-(Corredor)  
 X-  
 Y-  
 Z-

NQAI11  
 OBJECTO-Vaso esférico  
 MATERIAL-Cerâmica  
 QUADRADO-(Corredor)  
 X-  
 Y-  
 Z-

NQAI12  
 OBJECTO-Fragmento de taça  
 MATERIAL-Cerâmica  
 QUADRADO-(Corredor)  
 X-  
 Y-  
 Z-

NGAI13  
OBJECTO-Taca carenada com mamilos  
MATERIAL-Cerâmica  
QUADRADO-(Corredor)  
X-  
Y-  
Z-

NGAI15  
OBJECTO-Taca  
MATERIAL-Cerâmica  
QUADRADO-(Corredor)  
X-  
Y-  
Z-

NGAI16  
OBJECTO-Fragmento de taca  
MATERIAL-Cerâmica  
QUADRADO-(Corredor)  
X-  
Y-  
Z-

NGAI17  
OBJECTO-Fragmento de taca  
MATERIAL-Cerâmica  
QUADRADO-(Corredor)  
X-  
Y-  
Z-

NGAI19  
OBJECTO-Fragmento de taca  
MATERIAL-Cerâmica  
QUADRADO-(Corredor)  
X-  
Y-  
Z-

NGAI20  
OBJECTO-Fragmento de taca  
MATERIAL-Cerâmica  
QUADRADO-(Corredor)  
X-  
Y-  
Z-

NGAI21  
OBJECTO-Fragmento de taca carenada (?)  
MATERIAL-Cerâmica  
QUADRADO-(Corredor)  
X-  
Y-  
Z-

NGAI22  
OBJECTO-Taca  
MATERIAL-Cerâmica  
QUADRADO-(Corredor)  
X-  
Y-  
Z-

NGAI23  
OBJECTO-Fragmento de taca carenada  
MATERIAL-Cerâmica  
QUADRADO-(Corredor)  
X-  
Y-  
Z-

NGAI25  
OBJECTO-Fragmento de taca  
MATERIAL-Cerâmica  
QUADRADO-(Corredor)  
X-  
Y-  
Z-

NGAI26  
OBJECTO-Fragmento de taca  
MATERIAL-Cerâmica  
QUADRADO-(Corredor)  
X-  
Y-  
Z-

NGAI27  
OBJECTO-Ponta de seta  
MATERIAL-Sillex  
QUADRADO-(Corredor)  
X-  
Y-  
Z-

NºAI34  
OBJECTO-Ponta de seta  
MATERIAL-Silex  
QUADRADO-(Corredor)  
X-  
Y-  
Z-

NºAI35  
OBJECTO-Ponta de seta  
MATERIAL-Silex  
QUADRADO-(Corredor)  
X-  
Y-  
Z-

NºAI36  
OBJECTO-Ponta de seta  
MATERIAL-Silex  
QUADRADO-(Corredor)  
X-  
Y-  
Z-

NºAI37  
OBJECTO-Ponta de seta  
MATERIAL-Quartzo filoniano  
QUADRADO-(Corredor)  
X-  
Y-  
Z-

NºAI38  
OBJECTO-Ponta de seta  
MATERIAL-Quartzo filoniano  
QUADRADO-(Corredor)  
X-  
Y-  
Z-

NºAI39  
OBJECTO-Ponta de seta  
MATERIAL-Quartzo filoniano  
QUADRADO-  
X-  
Y-  
Z-

NºAI28  
OBJECTO-Fragmento de lámina  
MATERIAL-Silex  
QUADRADO-?  
X-  
Y-  
Z-

NºAI29  
OBJECTO-Ponta de seta  
MATERIAL-Silex  
QUADRADO-?  
X-  
Y-  
Z-

NºAI30  
OBJECTO-Geométrico  
MATERIAL-Silex  
QUADRADO-(Corredor)  
X-  
Y-  
Z-

NºAI31  
OBJECTO-Geométrico  
MATERIAL-Silex  
QUADRADO-(Corredor)  
X-  
Y-  
Z-

NºAI32  
OBJECTO-Lámina  
MATERIAL-Silex  
QUADRADO-(Corredor)  
X-  
Y-  
Z-

NºAI33  
OBJECTO-Ponta de seta  
MATERIAL-Silex  
QUADRADO-(Corredor)  
X-  
Y-  
Z-

NGAI40  
OBJECTO-Ponta de seta  
MATERIAL-Silex  
QUADRADO-(Corredor)  
X-  
Y-  
Z-

NGAI41  
OBJECTO-Ponta de seta  
MATERIAL-Silex  
QUADRADO-?  
X-  
Y-  
Z-

NGAI42  
OBJECTO-Ponta de seta  
MATERIAL-Silex  
QUADRADO-?  
X-  
Y-  
Z-

NGAI43  
OBJECTO-Ponta de seta  
MATERIAL-Silex  
QUADRADO-(Corredor)  
X-  
Y-  
Z-

NGAI54  
OBJECTO-Fragmento de idolo-placa  
MATERIAL-Xisto  
QUADRADO-(Corredor)  
X-  
Y-  
Z-

NGAI55  
OBJECTO-Fragmento de idolo-placa  
MATERIAL-Xisto  
QUADRADO-(Corredor)  
X-  
Y-  
Z-

NGAI56  
OBJECTO-Fragmento de idolo-placa  
MATERIAL-Xisto  
QUADRADO-(Corredor)  
X-  
Y-  
Z-

NGAI58  
OBJECTO-Lâmina  
MATERIAL-Silex  
QUADRADO-(Corredor)  
X-  
Y-  
Z-

NP  
OBJECTO-  
MATERIAL-  
QUADRADO-  
X-  
Y-  
Z-

NP  
OBJECTO-  
MATERIAL-  
QUADRADO-  
X-  
Y-  
Z-

NP  
OBJECTO-  
MATERIAL-  
QUADRADO-  
X-  
Y-  
Z-

NP  
OBJECTO-  
MATERIAL-  
QUADRADO-  
X-  
Y-  
Z-

ANTA  
**II do ALCOGULO**



ANTA DO ALCOGULO II

NºAII1	OBJECTO-Fragmento de taça carenada	NºAII7	OBJECTO-Machado fragmentado
	MATERIAL-Cerâmica		MATERIAL-Anfibolite
	QUADRADO-(Corredor)		QUADRADO-(Corredor)
X-		X-	
Y-		Y-	
Z-		Z-	
NºAII2	OBJECTO-Fragmento de taça	NºAII10	OBJECTO-Idolo-placa
	MATERIAL-Cerâmica		MATERIAL-Xisto
	QUADRADO-(Corredor)		QUADRADO-(Corredor)
X-		X-	
Y-		Y-	
Z-		Z-	
NºAII3	OBJECTO-Fragmento de taça carenada	NºAII13	OBJECTO-Ponta de seta
	MATERIAL-Cerâmica		MATERIAL-Silex
	QUADRADO-(Corredor)		QUADRADO-(Corredor)
X-		X-	
Y-		Y-	
Z-		Z-	
NºAII4	OBJECTO-Fragmento de taça	NºAII14	OBJECTO-Ponta de seta
	MATERIAL-Cerâmica		MATERIAL-Silex
	QUADRADO-(Corredor)		QUADRADO-(Corredor)
X-		X-	
Y-		Y-	
Z-		Z-	
NºAII5	OBJECTO-Machado	NºAII15	OBJECTO-Ponta de seta
	MATERIAL-Anfibolite		MATERIAL-Quartzó filoniano
	QUADRADO-(Corredor)		QUADRADO-(Corredor)
X-		X-	
Y-		Y-	
Z-		Z-	
NºAII6	OBJECTO-Machado	NºAII16	OBJECTO-Ponta de seta
	MATERIAL-Anfibolite		MATERIAL-Silex
	QUADRADO-(Corredor)		QUADRADO-(Corredor)
X-		X-	
Y-		Y-	
Z-		Z-	



NGA1117  
OBJECTO-Ponta de seta  
MATERIAL-Silex  
QUADRADO-(Corredor)  
X-  
Y-  
Z-

NGA1118  
OBJECTO-Ponta de seta  
MATERIAL-Quartzo filoniano  
QUADRADO-(Corredor)  
X-  
Y-  
Z-

NGA1119  
OBJECTO-Ponta de seta  
MATERIAL-Silex  
QUADRADO-(Corredor)  
X-  
Y-  
Z-

NGA1120  
OBJECTO-Ponta de seta  
MATERIAL-Quartzo hialino  
QUADRADO-(Corredor)  
X-  
Y-  
Z-

NGA1121  
OBJECTO-Ponta de seta  
MATERIAL-Quartzo filoniano  
QUADRADO-(Corredor)  
X-  
Y-  
Z-

NGA1122  
OBJECTO-Ponta de seta  
MATERIAL-Silex  
QUADRADO-(Corredor)  
X-  
Y-  
Z-

NGA1123  
OBJECTO-Ponta de seta  
MATERIAL-Silex  
QUADRADO-(Corredor)  
X-  
Y-  
Z-

NGA1124  
OBJECTO-Ponta de seta  
MATERIAL-Quartzo hialino  
QUADRADO-(Corredor)  
X-  
Y-  
Z-

NGA1125  
OBJECTO-Ponta de seta  
MATERIAL-Silex  
QUADRADO-(Corredor)  
X-  
Y-  
Z-

NGA1126  
OBJECTO-Ponta de seta  
MATERIAL-Xisto  
QUADRADO-(Corredor)  
X-  
Y-  
Z-

NGA1127  
OBJECTO-Ponta de seta  
MATERIAL-Xisto  
QUADRADO-(Corredor)  
X-  
Y-  
Z-

NGA1128  
OBJECTO-Ponta de seta  
MATERIAL-Silex  
QUADRADO-(Corredor)  
X-  
Y-  
Z-

N0AII35  
 OBJECTO-Ponta de seta  
 MATERIAL-Silex  
 QUADRADO-(Corredor)  
 X-  
 Y-  
 Z-

N0AII36  
 OBJECTO-Ponta de seta  
 MATERIAL-Quartzo hialino  
 QUADRADO-(Corredor)  
 X-  
 Y-  
 Z-

N0AII37  
 OBJECTO-Ponta de seta  
 MATERIAL-Silex  
 QUADRADO-(Corredor)  
 X-  
 Y-  
 Z-

N0AII38  
 OBJECTO-Ponta de seta  
 MATERIAL-Quartzo hialino  
 QUADRADO-(Corredor)  
 X-  
 Y-  
 Z-

N0AII39  
 OBJECTO-Ponta de seta  
 MATERIAL-Silex  
 QUADRADO-(Corredor)  
 X-  
 Y-  
 Z-

N0AII40  
 OBJECTO-Ponta de seta  
 MATERIAL-Silex  
 QUADRADO-(Corredor)  
 X-  
 Y-  
 Z-

N0AII29  
 OBJECTO-Ponta de seta  
 MATERIAL-Silex  
 QUADRADO-(Corredor)  
 X-  
 Y-  
 Z-

N0AII30  
 OBJECTO-Ponta de seta  
 MATERIAL-Silex  
 QUADRADO-(Corredor)  
 X-  
 Y-  
 Z-

N0AII31  
 OBJECTO-Ponta de seta  
 MATERIAL-Silex  
 QUADRADO-(Corredor)  
 X-  
 Y-  
 Z-

N0AII32  
 OBJECTO-Ponta de seta  
 MATERIAL-Quartzo filoniano  
 QUADRADO-(Corredor)  
 X-  
 Y-  
 Z-

N0AII33  
 OBJECTO-Ponta de seta  
 MATERIAL-Silex  
 QUADRADO-(Corredor)  
 X-  
 Y-  
 Z-

N0AII34  
 OBJECTO-Ponta de seta  
 MATERIAL-Silex  
 QUADRADO-(Corredor)  
 X-  
 Y-  
 Z-

NOAII41  
OBJECTO-Ponta de seta  
MATERIAL-Sillex  
QUADRADO-(Corredor)  
X-  
Y-  
Z-

NOAII42  
OBJECTO-Burfil  
MATERIAL-Sillex  
QUADRADO-(Corredor)  
X-  
Y-  
Z-

NOAII43  
OBJECTO-Ponta de seta  
MATERIAL-Sillex  
QUADRADO-(Corredor)  
X-  
Y-  
Z-

NOAII44  
OBJECTO-Ponta de seta (?)  
MATERIAL-Quartzo filoniano  
QUADRADO-(Corredor)  
X-  
Y-  
Z-

NOAII45  
OBJECTO-Ponta de seta  
MATERIAL-Sillex  
QUADRADO-(Corredor)  
X-  
Y-  
Z-

NOAII46  
OBJECTO-Fragmento de ponta de seta  
MATERIAL-Quartzo hialino  
QUADRADO-(Corredor)  
X-  
Y-  
Z-

NOAII47  
OBJECTO-Ponta de seta  
MATERIAL-Sillex  
QUADRADO-(Corredor)  
X-  
Y-  
Z-

NOAII48  
OBJECTO-Ponta de seta  
MATERIAL-Sillex  
QUADRADO-(Corredor)  
X-  
Y-  
Z-

NOAII49  
OBJECTO-Ponta de seta  
MATERIAL-Sillex  
QUADRADO-(Corredor)  
X-  
Y-  
Z-

NOAII50  
OBJECTO-Ponta de seta  
MATERIAL-Xisto  
QUADRADO-(Corredor)  
X-  
Y-  
Z-

NOAII51  
OBJECTO-Ponta de seta  
MATERIAL-Quartzo Hialino  
QUADRADO-(Corredor)  
X-  
Y-  
Z-

NOAII52  
OBJECTO-Ponta de seta  
MATERIAL-Sillex  
QUADRADO-(Corredor)  
X-  
Y-  
Z-

NQAI153  
OBJECTO-Ponta de seta  
MATERIAL-Quartzo filoniano  
QUADRADO-(Corredor)  
X-  
Y-  
Z-

NQAI154  
OBJECTO-Ponta de seta  
MATERIAL-Quartzo filoniano  
QUADRADO-(Corredor)  
X-  
Y-  
Z-

NQAI155  
OBJECTO-Ponta de seta  
MATERIAL-Quartzo filoniano  
QUADRADO-(Corredor)  
X-  
Y-  
Z-

NQAI156  
OBJECTO-Ponta de seta  
MATERIAL-Silex  
QUADRADO-(Corredor)  
X-  
Y-  
Z-

NQAI157  
OBJECTO-Ponta de seta  
MATERIAL-Quartzo Hialino  
QUADRADO-(Corredor)  
X-  
Y-  
Z-

NQAI158  
OBJECTO-Ponta de seta  
MATERIAL-Silex  
QUADRADO-(Corredor)  
X-  
Y-  
Z-

NQAI159  
OBJECTO-Ponta de seta  
MATERIAL-Xisto  
QUADRADO-(Corredor)  
X-  
Y-  
Z-

NQAI160  
OBJECTO-Ponta de seta  
MATERIAL-Xisto  
QUADRADO-(Corredor)  
X-  
Y-  
Z-

NQAI161  
OBJECTO-Ponta de seta  
MATERIAL-Xisto  
QUADRADO-(Corredor)  
X-  
Y-  
Z-

NQAI162  
OBJECTO-Ponta de seta  
MATERIAL-Xisto  
QUADRADO-(Corredor)  
X-  
Y-  
Z-

NQAI163  
OBJECTO-Fragmento de lámina  
MATERIAL-Silex  
QUADRADO-(Corredor)  
X-  
Y-  
Z-

NQAI164  
OBJECTO-Fragmento de lámina  
MATERIAL-Silex  
QUADRADO-(Corredor)  
X-  
Y-  
Z-

NGA1165  
OBJECTO-Geométrico  
MATERIAL-Silex  
QUADRADO-(Corredor)  
X-  
Y-  
Z-

NGA1166  
OBJECTO-Geométrico  
MATERIAL-Silex  
QUADRADO-(Corredor)  
X-  
Y-  
Z-

NGA1167  
OBJECTO-Fragmento de lâmina  
MATERIAL-Silex  
QUADRADO-(Corredor)  
X-  
Y-  
Z-

NGA1168  
OBJECTO-Fragmento de lâmina  
MATERIAL-Silex  
QUADRADO-(Corredor)  
X-  
Y-  
Z-

NGA1169  
OBJECTO-Lamina  
MATERIAL-Silex  
QUADRADO-(Corredor)  
X-  
Y-  
Z-

NGA1170  
OBJECTO-Buril (?)  
MATERIAL-Silex  
QUADRADO-(Corredor)  
X-  
Y-  
Z-

NGA1172  
OBJECTO-Geométrico  
MATERIAL-Silex  
QUADRADO-(Corredor)  
X-  
Y-  
Z-

NGA1175  
OBJECTO-Fragmento de lâmina  
MATERIAL-Silex  
QUADRADO-(Corredor)  
X-  
Y-  
Z-

NGA1179  
OBJECTO-Fragmento de taça  
MATERIAL-Cerâmica  
QUADRADO-(Corredor)  
X-  
Y-  
Z-

NGA1180  
OBJECTO-Fragmento de vaso acampanado  
MATERIAL-Cerâmica  
QUADRADO-(Corredor)  
X-  
Y-  
Z-

NGA1181  
OBJECTO-Fragmento de taça  
MATERIAL-Cerâmica  
QUADRADO-(Corredor)  
X-  
Y-  
Z-

NGA1182  
OBJECTO-Fragmento de taça  
MATERIAL-Cerâmica  
QUADRADO-(Corredor)  
X-  
Y-  
Z-

NºAII84  
OBJECTO-Fragmento de taça carenada (?)  
MATERIAL-Cerâmica  
QUADRADO-(Corredor)  
X-  
Y-  
Z-

NºAII85  
OBJECTO-Fragmento de taça carenada  
MATERIAL-Cerâmica  
QUADRADO-(Corredor)  
X-  
Y-  
Z-

NºAII86  
OBJECTO-Fragmento de vaso  
MATERIAL-Cerâmica  
QUADRADO-(Corredor)  
X-  
Y-  
Z-

NºAII87  
OBJECTO-Fragmento de taça  
MATERIAL-Cerâmica  
QUADRADO-(Corredor)  
X-  
Y-  
Z-

NºAII88  
OBJECTO-Fragmento de taça carenada  
MATERIAL-Cerâmica  
QUADRADO-(Corredor)  
X-  
Y-  
Z-

NºAII89  
OBJECTO-Fragmento de taça semi-esférica  
MATERIAL-Cerâmica  
QUADRADO-(Corredor)  
X-  
Y-  
Z-

NºAII90  
OBJECTO-Fragmento de taça carenada  
MATERIAL-Cerâmica  
QUADRADO-(Corredor)  
X-  
Y-  
Z-

NºAII91  
OBJECTO-Fragmento de taça  
MATERIAL-Cerâmica  
QUADRADO-(Corredor)  
X-  
Y-  
Z-

NºAII92  
OBJECTO-Fragmento de taça  
MATERIAL-Cerâmica  
QUADRADO-(Corredor)  
X-  
Y-  
Z-

NºAII94  
OBJECTO-Fragmento de taça carenada  
MATERIAL-Cerâmica  
QUADRADO-(Corredor)  
X-  
Y-  
Z-

NºAII95  
OBJECTO-Fragmento de taça  
MATERIAL-Cerâmica  
QUADRADO-(Corredor)  
X-  
Y-  
Z-

NºAII96  
OBJECTO-Fragmento de taça  
MATERIAL-Cerâmica  
QUADRADO-(Corredor)  
X-  
Y-  
Z-

NGAII197  
OBJECTO-Fragmento de taça  
MATERIAL-Cerâmica  
QUADRADO-(Corredor)  
X-  
Y-  
Z-

NGAII198  
OBJECTO-Fragmento de taça  
MATERIAL-Cerâmica  
QUADRADO-(Corredor)  
X-  
Y-  
Z-

NGAII199  
OBJECTO-Fragmento de taça  
MATERIAL-Cerâmica  
QUADRADO-(Corredor)  
X-  
Y-  
Z-

NGAII100  
OBJECTO-Fragmento de taça carenada (?)  
MATERIAL-Cerâmica  
QUADRADO-(Corredor)  
X-  
Y-  
Z-

NGAII101  
OBJECTO-Fragmento de taça  
MATERIAL-Cerâmica  
QUADRADO-(Corredor)  
X-  
Y-  
Z-

NGAII102  
OBJECTO-Fragmento de taça  
MATERIAL-Cerâmica  
QUADRADO-(Corredor)  
X-  
Y-  
Z-

NGAII103  
OBJECTO-Fragmento de taça carenada  
MATERIAL-Cerâmica  
QUADRADO-(Corredor)  
X-  
Y-  
Z-

NGAII104  
OBJECTO-Fragmento de taça  
MATERIAL-Cerâmica  
QUADRADO-(Corredor)  
X-  
Y-  
Z-

NGAII105  
OBJECTO-Fragmento de taça carenada  
MATERIAL-Cerâmica  
QUADRADO-(Corredor)  
X-  
Y-  
Z-

NGAII106  
OBJECTO-Fragmento de taça  
MATERIAL-Cerâmica  
QUADRADO-(Corredor)  
X-  
Y-  
Z-

NGAII107  
OBJECTO-Fragmento de taça  
MATERIAL-Cerâmica  
QUADRADO-(Corredor)  
X-  
Y-  
Z-

NGAII108  
OBJECTO-Fragmento de taça carenada  
MATERIAL-Cerâmica  
QUADRADO-(Corredor)  
X-  
Y-  
Z-

NºAII109  
OBJECTO-Fragmento de taça carenada (?)  
MATERIAL-Cerâmica  
QUADRADO-(Corredor)  
X-  
Y-  
Z-

NºAII110  
OBJECTO-Fragmento de taça carenada  
MATERIAL-Cerâmica  
QUADRADO-(Corredor)  
X-  
Y-  
Z-

NºAII111  
OBJECTO-Fragmento de taça  
MATERIAL-Cerâmica  
QUADRADO-(Corredor)  
X-  
Y-  
Z-

NºAII112  
OBJECTO-Fragmento de taça  
MATERIAL-Cerâmica  
QUADRADO-(Corredor)  
X-  
Y-  
Z-

Nº  
OBJECTO-  
MATERIAL-  
QUADRADO-  
X-  
Y-  
Z-

Nº  
OBJECTO-  
MATERIAL-  
QUADRADO-  
X-  
Y-  
Z-





ANTA  
**I do CEREJEIRO**



ANTA  
**I dos COURELEIROS**



ANTA I DOS COURELEIROS

NºCI1  
 OBJECTO-Idolo-placa  
 MATERIAL-Xisto  
 QUADRADO-F6  
 X-130cm  
 Y-193cm  
 Z-300cm

NºCI2  
 OBJECTO-Idolo-placa  
 MATERIAL-Xisto  
 QUADRADO-G7  
 X-5cm  
 Y-5cm  
 Z-288cm

NºCI3  
 OBJECTO-Idolo-placa  
 MATERIAL-Xisto  
 QUADRADO-F8  
 X-88cm  
 Y-185cm  
 Z-284cm

NºCI4  
 OBJECTO-Idolo-placa  
 MATERIAL-Xisto  
 QUADRADO-G7  
 X-5cm  
 Y-5cm  
 Z-285cm

NºCI5  
 OBJECTO-Fragmento de idolo-placa  
 MATERIAL-Xisto  
 QUADRADO-G8  
 X-117cm  
 Y-20cm  
 Z-310cm

NºCI6  
 OBJECTO-Enxó  
 MATERIAL-Anfibolite  
 QUADRADO-F8  
 X-130cm  
 Y-97cm  
 Z-306cm

NºCI7  
 OBJECTO-Machado  
 MATERIAL-Anfibolite  
 QUADRADO-F7  
 X-110cm  
 Y-44cm  
 Z-311cm

NºCI10  
 OBJECTO-Percutor  
 MATERIAL-Quartzó filoniano  
 QUADRADO-F9  
 X-20cm  
 Y-73cm  
 Z-306cm

NºCI11  
 OBJECTO-Fragmento de lâmina  
 MATERIAL-Sílex  
 QUADRADO-F6  
 X-110cm  
 Y-110cm  
 Z-306cm

NºCI12  
 OBJECTO-Fragmento de lâmina  
 MATERIAL-Sílex  
 QUADRADO-G8  
 X-80cm  
 Y-170cm  
 Z-306cm

NºCI13  
 OBJECTO-Resto de talhe  
 MATERIAL-Sílex  
 QUADRADO-G6  
 X-80cm  
 Y-60cm  
 Z-304cm

NºCI14  
 OBJECTO-Resto de talhe  
 MATERIAL-Sílex  
 QUADRADO-E8  
 X-64cm  
 Y-135cm  
 Z-300cm

NECI15  
OBJETO-Geométrico  
MATERIAL-Sílex  
QUADRADO-G6  
X-22cm  
Y-47cm  
Z-304cm

NECI16  
OBJETO-Fragmento de lâmina  
MATERIAL-Sílex  
QUADRADO-F7  
X-  
Y-  
Z-  
Crivo

NECI17  
OBJETO-Resto de talhe  
MATERIAL-Sílex  
QUADRADO-F6  
X-110cm  
Y-110cm  
Z-306cm

NECI20  
OBJETO-Fragmento de taça esférica  
MATERIAL-Cerâmica  
QUADRADO-F7  
X-150cm  
Y-123cm  
Z-310cm

NECI21  
OBJETO-Fragmento de vaso esférico  
MATERIAL-Cerâmica  
QUADRADO-F9  
X-101cm  
Y-33cm  
Z-323cm

NECI22  
OBJETO-Fragmento de bordo de taça carenada (?)  
MATERIAL-Cerâmica  
QUADRADO-?  
X-  
Y-  
Z-Superfície

NECI25  
OBJETO-Fragmento de bordo de vaso esférico  
MATERIAL-Cerâmica  
QUADRADO-F9  
X-0cm  
Y-144cm  
Z-306cm

NECI26  
OBJETO-Fragmento de bordo de vaso esférico  
MATERIAL-Cerâmica  
QUADRADO-F9  
X-  
Y-  
Z-  
Crivo

NECI27  
OBJETO-Ponta de seta  
MATERIAL-Quartzó filoniano  
QUADRADO-F9  
X-110cm  
Y-96cm  
Z-306cm

NECI28  
OBJETO-Ponta de seta  
MATERIAL-Quartzó filoniano  
QUADRADO-G6  
X-140cm  
Y-160cm  
Z-300cm

NECI29  
OBJETO-Fragmento de lâmina  
MATERIAL-Sílex  
QUADRADO-F8  
X-88cm  
Y-185cm  
Z-284cm

N9  
OBJETO-  
MATERIAL-  
QUADRADO-  
X-  
Y-  
Z-

ANTA  
**II dos COURELEIROS**





N9CII1  
 OBJECTO-Ponta de seta  
 MATERIAL-Silex  
 QUADRADO-L10  
 X-  
 Y-  
 Z-  
 Crivo

N9CII2  
 OBJECTO-Fragmento de ponta de seta  
 MATERIAL-Xisto jaspoide  
 QUADRADO-J10  
 X-  
 Y-  
 Z-Superficie

N9CII3  
 OBJECTO-Fragmento de ponta de seta  
 MATERIAL-Silex  
 QUADRADO-J9  
 X-  
 Y-  
 Z-Superficie

N9CII4  
 OBJECTO-Fragmento de ponta de seta  
 MATERIAL-Xisto jaspoide  
 QUADRADO-J8  
 X-  
 Y-  
 Z-Superficie

N9CII5  
 OBJECTO-Ponta de seta  
 MATERIAL-Silex  
 QUADRADO-J10  
 X-  
 Y-  
 Z-289cm

N9CII6  
 OBJECTO-Ponta de seta  
 MATERIAL-Xisto jaspoide  
 QUADRADO-J10  
 X-  
 Y-  
 Z-288cm

N9CII7  
 OBJECTO-Fragmento de ponta de seta  
 MATERIAL-Silex  
 QUADRADO-L10  
 X-180cm  
 Y-70cm  
 Z-286cm

N9CII9  
 OBJECTO-Fragmento de ponta de seta  
 MATERIAL-Xisto jaspoide  
 QUADRADO-L9  
 X-  
 Y-  
 Z-  
 Crivo

N9CII10  
 OBJECTO-Fragmento de ponta de seta  
 MATERIAL-Silex  
 QUADRADO-L10  
 X-  
 Y-  
 Z-Superficie

N9CII11  
 OBJECTO-Fragmento de ponta de seta  
 MATERIAL-Silex  
 QUADRADO-L9  
 X-  
 Y-  
 Z-Superficie

N9CII12  
 OBJECTO-Ponta de seta  
 MATERIAL-Xisto jaspoide  
 QUADRADO-L9  
 X-190cm  
 Y-110cm  
 Z-290cm

N9CII13  
 OBJECTO-Ponta de seta  
 MATERIAL-Quartzo filoniano  
 QUADRADO-L10  
 X-160cm  
 Y-120cm  
 Z-302cm

NeCII14  
OBJECTO-Ponta de seta  
MATERIAL-Silex  
QUADRADO-L9  
X-160cm  
Y-70cm  
Z-190cm

NeCII15  
OBJECTO-Ponta de seta  
MATERIAL-Xisto jaspóide  
QUADRADO-? (câmara)  
X-  
Y-  
Z-Superfície

NeCII16  
OBJECTO-Fragmento (?) de ponta de seta  
MATERIAL-Silex  
QUADRADO-M10  
X-  
Y-  
Z-  
Crivo

NeCII17  
OBJECTO-Ponta de seta  
MATERIAL-Silex  
QUADRADO-H9  
X-  
Y-  
Z-Superfície

NeCII18  
OBJECTO-Conta de colar  
MATERIAL-Xisto  
QUADRADO-J10  
X-  
Y-  
Z-289cm

NeCII19  
OBJECTO-Lamela  
MATERIAL-Quartzó hialino  
QUADRADO-J10  
X-  
Y-  
Z-  
Crivo

NeCII20  
OBJECTO-Lamela  
MATERIAL-Quartzó filoniano  
QUADRADO-L9  
X-  
Y-  
Z-  
Crivo

NeCII21  
OBJECTO-Fragmento de lamela  
MATERIAL-Silex  
QUADRADO-H8  
X-  
Y-  
Z-superfície

NeCII23  
OBJECTO-Lâmina  
MATERIAL-Silex  
QUADRADO-J9  
X-188cm  
Y-154cm  
Z-246cm

NeCII24  
OBJECTO-Fragmento de lâmina  
MATERIAL-Silex  
QUADRADO-L10  
X-75cm  
Y-45cm  
Z-289cm

NeCII25  
OBJECTO-Fragmento de lâmina  
MATERIAL-Silex  
QUADRADO-L10  
X-  
Y-  
Z-289cm

NeCII28  
OBJECTO-Fragmento de lâmina  
MATERIAL-Silex  
QUADRADO-? Câmara  
X-  
Y-  
Z-Superfície

N0CII29  
OBJECTO-Geométrico  
MATERIAL-Silex  
QUADRADO-L10  
X-  
Y-  
Z-289cm

N0CII30  
OBJECTO-Geométrico  
MATERIAL-Silex  
QUADRADO-J10  
X-  
Y-  
Z-289cm

N0CII35  
OBJECTO-Fragmento de ídolo-placa  
MATERIAL-Xisto ardosiario  
QUADRADO-L10  
X-25cm  
Y-125cm  
Z-254cm

N0CII36  
OBJECTO-Fragmento de ídolo-placa  
MATERIAL-Grés  
QUADRADO-L9  
X-110cm  
Y-80cm  
Z-290cm

N0CII37  
OBJECTO-Fragmento de machado (?)  
MATERIAL-Anfibolite  
QUADRADO-J10  
X-183cm  
Y-85cm  
Z-Superficie

N0CII38  
OBJECTO-Fragmento de machado (?)  
MATERIAL-Anfibolite  
QUADRADO-J9  
X-153cm  
Y-163cm  
Z-226cm

N0CII39  
OBJECTO-Machado  
MATERIAL-Anfibolite  
QUADRADO-L9  
X-65cm  
Y-180cm  
Z-283cm

N0CII43  
OBJECTO-Percutor  
MATERIAL-Quartzo filoniano  
QUADRADO-L9  
X-  
Y-  
Z-Superficie

N0CII44  
OBJECTO-Fragmento de ídolo-placa  
MATERIAL-Grés  
QUADRADO-J10  
X-  
Y-  
Z-Superficie

N0CII47  
OBJECTO-Fragmento de bordo de vaso  
MATERIAL-Cerámica  
QUADRADO-? Mamoá  
X-  
Y-  
Z-Superficie

N0CII48  
OBJECTO-Fragmento de taça carenada  
MATERIAL-Cerámica  
QUADRADO-L10  
X-  
Y-  
Z-257cm

N0CII49  
OBJECTO-Fragmento de taça carenada  
MATERIAL-Cerámica  
QUADRADO-L9  
X-  
Y-  
Z-Superficie

N9C1152  
 OBJETO-Fragmento de taça carenada  
 MATERIAL-Cerâmica  
 QUADRADO-19  
 X-30cm  
 Y-198cm  
 Z-287cm

N9C1153  
 OBJETO-Fragmento de taça semi-esférica  
 MATERIAL-Cerâmica  
 QUADRADO-110  
 X-120cm  
 Y-170cm  
 Z-285cm

N9C1154  
 OBJETO-Fragmento de taça carenada  
 MATERIAL-Cerâmica  
 QUADRADO-110  
 X-2cm  
 Y-50cm  
 Z-287cm

N9C1155  
 OBJETO-Fragmento de taça esférica  
 MATERIAL-Cerâmica  
 QUADRADO-19  
 X-83cm  
 Y-194cm  
 Z-286cm

N9C1157  
 OBJETO-Fragmento de taça carenada  
 MATERIAL-Cerâmica  
 QUADRADO-19  
 X-180cm  
 Y-30cm  
 Z-302cm

N9C1158  
 OBJETO-Fragmento de bordo de vaso(?)  
 MATERIAL-Cerâmica  
 QUADRADO-110  
 X-  
 Y-  
 Z-Superfície

N9C1159  
 OBJETO-Fragmento de taça carenada (?)  
 MATERIAL-Cerâmica  
 QUADRADO-J10  
 X-  
 Y-  
 Z-292cm

N9C1160  
 OBJETO-Fragmento de taça carenada com mamilo  
 MATERIAL-Cerâmica  
 QUADRADO-(?)Câmara  
 X-  
 Y-  
 Z-Superfície

N9C1161  
 OBJETO-Fragmento de taça acampanada  
 MATERIAL-Cerâmica  
 QUADRADO-(?) Câmara  
 X-  
 Y-  
 Z-Superfície

N9C1162  
 OBJETO-Fragmento de bordo de vaso esférico (?)  
 MATERIAL-Cerâmica  
 QUADRADO-(?) Câmara  
 X-  
 Y-  
 Z-Superfície

N9C1164  
 OBJETO-Perutor  
 MATERIAL-Quartzo filoniano  
 QUADRADO-(?) Câmara  
 X-  
 Y-  
 Z-Superfície

N9C1165  
 OBJETO-Enxó  
 MATERIAL-Anfibolite  
 QUADRADO-? (câmara)  
 X-  
 Y-  
 Z-

N9CII66  
OBJECTO-Machado  
MATERIAL-Anfibolite  
QUADRADO-? (cámara)  
X-  
Y-  
Z-

N9CII67  
OBJECTO-Machado  
MATERIAL-Anfibolite  
QUADRADO-? (cámara)  
X-  
Y-  
Z-

N9CII68  
OBJECTO-Machado  
MATERIAL-Anfibolite  
QUADRADO-? (cámara)  
X-  
Y-  
Z-

N9CII69  
OBJECTO-Machado  
MATERIAL-Anfibolite  
QUADRADO-? (cámara)  
X-  
Y-  
Z-

N9CII70  
OBJECTO-Enxó  
MATERIAL-Anfibolite  
QUADRADO-? (cámara)  
X-  
Y-  
Z-

N9CII71  
OBJECTO-Fragmento de idolo-placa  
MATERIAL-Xisto ardosiario  
QUADRADO-? (cámara)  
X-  
Y-  
Z-

N9CII72  
OBJECTO-Fragmento de idolo-placa  
MATERIAL-Xisto ardosiario  
QUADRADO-? (cámara)  
X-  
Y-  
Z-

N9CII73  
OBJECTO-Lámina  
MATERIAL-Silex  
QUADRADO-? (cámara)  
X-  
Y-  
Z-

N9CII74  
OBJECTO-Fragmento de lámina  
MATERIAL-Silex  
QUADRADO-? (cámara)  
X-  
Y-  
Z-

N9CII75  
OBJECTO-Fragmento de lámina  
MATERIAL-Silex  
QUADRADO-? (cámara)  
X-  
Y-  
Z-

N9CII76  
OBJECTO-Conta de colar  
MATERIAL-Rocha verde  
QUADRADO-? (cámara)  
X-  
Y-  
Z-

N9CII77  
OBJECTO-Conta de colar  
MATERIAL-Xisto  
QUADRADO-? (cámara)  
X-  
Y-  
Z-

NECII178  
OBJECTO-Conta de colar  
MATERIAL-Xisto  
QUADRADO-? (câmara)  
X-  
Y-  
Z-

NECII179  
OBJECTO-Conta de colar  
MATERIAL-Xisto  
QUADRADO-? (câmara)  
X-  
Y-  
Z-

NECII180  
OBJECTO-Conta de colar  
MATERIAL-Xisto  
QUADRADO-? (câmara)  
X-  
Y-  
Z-

NECII181  
OBJECTO-Conta de colar  
MATERIAL-Xisto  
QUADRADO-? (câmara)  
X-  
Y-  
Z-

NECII182  
OBJECTO-Conta de colar  
MATERIAL-Xisto  
QUADRADO-? (câmara)  
X-  
Y-  
Z-

NECII183  
OBJECTO-Conta de colar  
MATERIAL-Xisto  
QUADRADO-? (câmara)  
X-  
Y-  
Z-

NECII184  
OBJECTO-Conta de colar  
MATERIAL-Xisto  
QUADRADO-? (câmara)  
X-  
Y-  
Z-

NECII185  
OBJECTO-Conta de colar  
MATERIAL-Xisto  
QUADRADO-? (câmara)  
X-  
Y-  
Z-

NECII186  
OBJECTO-Conta de colar  
MATERIAL-Xisto  
QUADRADO-? (câmara)  
X-  
Y-  
Z-

NECII187  
OBJECTO-Conta de colar  
MATERIAL-Xisto  
QUADRADO-? (câmara)  
X-  
Y-  
Z-

NECII188  
OBJECTO-Conta de colar  
MATERIAL-Xisto  
QUADRADO-? (câmara)  
X-  
Y-  
Z-

NECII189  
OBJECTO-Conta de colar  
MATERIAL-Xisto  
QUADRADO-? (câmara)  
X-  
Y-  
Z-

N9CII96  
OBJECTO-Conta de colar  
MATERIAL-Xisto  
QUADRADO-? (cámara)  
X-  
Y-  
Z-

N9CII97  
OBJECTO-Conta de colar  
MATERIAL-Xisto  
QUADRADO-? (cámara)  
X-  
Y-  
Z-

N9CII98  
OBJECTO-Conta de colar  
MATERIAL-Xisto  
QUADRADO-? (cámara)  
X-  
Y-  
Z-

N9CII99  
OBJECTO-Conta de colar  
MATERIAL-Xisto  
QUADRADO-? (cámara)  
X-  
Y-  
Z-

N9CII100  
OBJECTO-Conta de colar  
MATERIAL-Xisto  
QUADRADO-? (cámara)  
X-  
Y-  
Z-

N9CII101  
OBJECTO-Conta de colar  
MATERIAL-Xisto  
QUADRADO-? (cámara)  
X-  
Y-  
Z-

N9CII90  
OBJECTO-Conta de colar  
MATERIAL-Xisto  
QUADRADO-? (cámara)  
X-  
Y-  
Z-

N9CII91  
OBJECTO-Conta de colar  
MATERIAL-Xisto  
QUADRADO-? (cámara)  
X-  
Y-  
Z-

N9CII92  
OBJECTO-Conta de colar  
MATERIAL-Xisto  
QUADRADO-? (cámara)  
X-  
Y-  
Z-

N9CII93  
OBJECTO-Conta de colar  
MATERIAL-Xisto  
QUADRADO-? (cámara)  
X-  
Y-  
Z-

N9CII94  
OBJECTO-Conta de colar  
MATERIAL-Xisto  
QUADRADO-? (cámara)  
X-  
Y-  
Z-

N9CII95  
OBJECTO-Conta de colar  
MATERIAL-Xisto  
QUADRADO-? (cámara)  
X-  
Y-  
Z-



NECII102  
OBJECTO-Conta de colar  
MATERIAL-Xisto  
QUADRADO-? (câmara)  
X-  
Y-  
Z-

NECII103  
OBJECTO-Conta de colar  
MATERIAL-Xisto  
QUADRADO-? (câmara)  
X-  
Y-  
Z-

NECII104  
OBJECTO-Conta de colar  
MATERIAL-Xisto  
QUADRADO-? (câmara)  
X-  
Y-  
Z-

NECII105  
OBJECTO-Conta de colar  
MATERIAL-Xisto  
QUADRADO-? (câmara)  
X-  
Y-  
Z-

NECII106  
OBJECTO-Conta de colar  
MATERIAL-Xisto  
QUADRADO-? (câmara)  
X-  
Y-  
Z-

NECII107  
OBJECTO-Conta de colar  
MATERIAL-Xisto  
QUADRADO-? (câmara)  
X-  
Y-  
Z-

NECII108  
OBJECTO-Conta de colar  
MATERIAL-Xisto  
QUADRADO-? (câmara)  
X-  
Y-  
Z-

NECII109  
OBJECTO-Conta de colar  
MATERIAL-Xisto  
QUADRADO-? (câmara)  
X-  
Y-  
Z-

NECII110  
OBJECTO-Conta de colar  
MATERIAL-Xisto  
QUADRADO-? (câmara)  
X-  
Y-  
Z-

NECII111  
OBJECTO-Conta de colar  
MATERIAL-Xisto  
QUADRADO-? (câmara)  
X-  
Y-  
Z-

NECII112  
OBJECTO-Conta de colar  
MATERIAL-Xisto  
QUADRADO-? (câmara)  
X-  
Y-  
Z-

NECII113  
OBJECTO-Conta de colar  
MATERIAL-Xisto  
QUADRADO-? (câmara)  
X-  
Y-  
Z-

N9CII114  
OBJECTO-Conta de colar  
MATERIAL-Xisto  
QUADRADO-? (cámara)  
X-  
Y-  
Z-

N9CII115  
OBJECTO-Conta de colar  
MATERIAL-Xisto  
QUADRADO-? (cámara)  
X-  
Y-  
Z-

N9CII116  
OBJECTO-Conta de colar  
MATERIAL-Xisto  
QUADRADO-? (cámara)  
X-  
Y-  
Z-

N9CII117  
OBJECTO-Conta de colar  
MATERIAL-Xisto  
QUADRADO-? (cámara)  
X-  
Y-  
Z-

N9CII118  
OBJECTO-Conta de colar  
MATERIAL-Xisto  
QUADRADO-? (cámara)  
X-  
Y-  
Z-

N9CII119  
OBJECTO-Conta de colar  
MATERIAL-Xisto  
QUADRADO-? (cámara)  
X-  
Y-  
Z-

N9CII120  
OBJECTO-Conta de colar  
MATERIAL-Xisto  
QUADRADO-? (cámara)  
X-  
Y-  
Z-

N9CII121  
OBJECTO-Conta de colar  
MATERIAL-Xisto  
QUADRADO-? (cámara)  
X-  
Y-  
Z-

N9CII122  
OBJECTO-Conta de colar  
MATERIAL-Xisto  
QUADRADO-? (cámara)  
X-  
Y-  
Z-

N9CII123  
OBJECTO-Conta de colar  
MATERIAL-Xisto  
QUADRADO-? (cámara)  
X-  
Y-  
Z-

N9CII124  
OBJECTO-Conta de colar  
MATERIAL-Xisto  
QUADRADO-? (cámara)  
X-  
Y-  
Z-

N9CII125  
OBJECTO-Conta de colar  
MATERIAL-Xisto  
QUADRADO-? (cámara)  
X-  
Y-  
Z-

NeCII126  
OBJECTO-Conta de colar  
MATERIAL-Xisto  
QUADRADO-? (câmara)  
X-  
Y-  
Z-

NeCII127  
OBJECTO-Conta de colar  
MATERIAL-Xisto  
QUADRADO-? (câmara)  
X-  
Y-  
Z-

NeCII128  
OBJECTO-Ponta de seta  
MATERIAL-Silex  
QUADRADO-? (câmara)  
X-  
Y-  
Z-

NeCII129  
OBJECTO-Ponta de seta  
MATERIAL-Silex  
QUADRADO-? (câmara)  
X-  
Y-  
Z-

NeCII130  
OBJECTO-Ponta de seta  
MATERIAL-Xisto ardosiano  
QUADRADO-? (câmara)  
X-  
Y-  
Z-

Ne  
OBJECTO-  
MATERIAL-  
QUADRADO-  
X-  
Y-  
Z-

ANTA  
**III dos COURELEIROS**



ANTA DOS COURELEIROS III

N9CIII1  
 OBJECTO-Machado  
 MATERIAL-Anfibolite  
 QUADRADO-M13  
 X-90cm  
 Y-160cm  
 Z-174cm

N9CIII2  
 OBJECTO-Fragmento de lâmina  
 MATERIAL-Silex  
 QUADRADO-M13  
 X-  
 Y-  
 Z-182cm

N9CIII3  
 OBJECTO-Fragmento de lâmina  
 MATERIAL-Silex  
 QUADRADO-M13  
 X-160cm  
 Y-183cm  
 Z-182cm

N9CIII6  
 OBJECTO-Cristal de quartzo com levantamentos  
 MATERIAL-Quartzo hialino  
 QUADRADO-M14  
 X-155cm  
 Y-93cm  
 Z-182cm

N9CIII8  
 OBJECTO-Geométrico  
 MATERIAL-Silex  
 QUADRADO-M13  
 X-110cm  
 Y-105cm  
 Z-100cm

N9CIII9  
 OBJECTO-Machado  
 MATERIAL-Anfibolite  
 QUADRADO-N13  
 X-180cm  
 Y-200cm  
 Z-178cm

N9CIII10  
 OBJECTO-Machado  
 MATERIAL-Anfibolite  
 QUADRADO-N13  
 X-102cm  
 Y-89cm  
 Z-260cm

N9CIII11  
 OBJECTO-Machado  
 MATERIAL-Anfibolite  
 QUADRADO-N13  
 X-84cm  
 Y-82cm  
 Z-158cm

N9CIII12  
 OBJECTO-Machado  
 MATERIAL-Anfibolite  
 QUADRADO-N14  
 X-185cm  
 Y-0cm  
 Z-184cm

N9CIII13  
 OBJECTO-Pilão  
 MATERIAL-Quartzito  
 QUADRADO-N14  
 X-180cm  
 Y-18cm  
 Z-184cm

N9CIII14  
 OBJECTO-Machado  
 MATERIAL-Anfibolite  
 QUADRADO-O14  
 X-5cm  
 Y-2cm  
 Z-184cm

N9CIII15  
 OBJECTO-Machado  
 MATERIAL-Anfibolite  
 QUADRADO-M13  
 X-123cm  
 Y-97cm  
 Z-189cm

NeCII116  
OBJETO-Machado  
MATERIAL-Anfibolite  
QUADRADO-N13  
X-60cm  
Y-100cm  
Z-184cm

NeCII117  
OBJETO-Enxó  
MATERIAL-Anfibolite  
QUADRADO-N13  
X-110cm  
Y-100cm  
Z-184cm

NeCII118  
OBJETO-Machado  
MATERIAL-Anfibolite  
QUADRADO-N13  
X-140cm  
Y-185cm  
Z-192cm

NeCII119  
OBJETO-Fragmento de lamela (?)  
MATERIAL-Silex  
QUADRADO-N14  
X-  
Y-  
Z-185cm

NeCII120  
OBJETO-Geométrico  
MATERIAL-Silex  
QUADRADO-N13  
X-  
Y-  
Z-Superfície

NeCII124  
OBJETO-Resto de talhe  
MATERIAL-Silex  
QUADRADO-M12 (mamao)  
X-  
Y-  
Z-  
Crivo

NeCII125  
OBJETO-Cristal com vestígios de levantamentos  
MATERIAL-Quartzo hialino  
QUADRADO-M12  
X-159cm  
Y-80cm  
Z-162cm

NeCII126  
OBJETO-Resto de talhe  
MATERIAL-Silex  
QUADRADO-M12 (mamao)  
X-  
Y-  
Z-  
Crivo

NeCII127  
OBJETO-Cristal com vestígios de utilização  
MATERIAL-Quartzo filoniano  
QUADRADO-O12  
X-  
Y-  
Z-  
Crivo

NeCII128  
OBJETO-Pé (?)  
MATERIAL-Granito  
QUADRADO-N13  
X-  
Y-  
Z-Superfície

Ne  
OBJETO-  
MATERIAL-  
QUADRADO-  
X-  
Y-  
Z-

Ne  
OBJETO-  
MATERIAL-  
QUADRADO-  
X-  
Y-  
Z-

ANTA  
**IV dos COURELEIROS**





ANTA IV DOS COURELEIROS

N9CIV1  
OBJETO-Geométrico  
MATERIAL-Silex  
QUADRADO-F11  
X-40cm  
Y-160cm  
Z-170cm

N9CIV2  
OBJETO-Fragmento de lamela  
MATERIAL-Silex  
QUADRADO-F12  
X-  
Y-  
Z-168cm

N9CIV3  
OBJETO-Conta de colar  
MATERIAL-Xisto  
QUADRADO-F10  
X-  
Y-  
Z-170cm

N9CIV4  
OBJETO-Conta de colar  
MATERIAL-Xisto  
QUADRADO-F10  
X-129cm  
Y-165cm  
Z-107cm

N9CIV5  
OBJETO-Conta de colar  
MATERIAL-Xisto  
QUADRADO-F12  
X-  
Y-  
Z-145cm

N9CIV6  
OBJETO-Conta de colar  
MATERIAL-Rocha verde  
QUADRADO-F10  
X-  
Y-  
Z-185cm

N9CIV7  
OBJETO-Conta de colar  
MATERIAL-Xisto  
QUADRADO-G12  
X-  
Y-  
Z-155cm

N9CIV8  
OBJETO-Conta de colar  
MATERIAL-Xisto  
QUADRADO-F12  
X-90cm  
Y-170cm  
Z-177cm

N9CIV9  
OBJETO-Conta de colar  
MATERIAL-Xisto  
QUADRADO-F10  
X-110cm  
Y-127cm  
Z-180cm

N9CIV10  
OBJETO-Conta de colar  
MATERIAL-Xisto  
QUADRADO-F11  
X-  
Y-  
Z-195cm

N9CIV11  
OBJETO-Conta de colar  
MATERIAL-Xisto  
QUADRADO-F11  
X-  
Y-  
Z-160cm

N9CIV12  
OBJETO-Conta de colar  
MATERIAL-Xisto  
QUADRADO-F11  
X-  
Y-  
Z-165cm

NECIV13  
OBJECTO-Conta de colar  
MATERIAL-Xisto  
QUADRADO-F10  
X-80cm  
Y-200cm  
Z-158cm

NECIV14  
OBJECTO-Conta de colar  
MATERIAL-Xisto  
QUADRADO-F11  
X-  
Y-  
Z-189cm

NECIV15  
OBJECTO-Conta de colar  
MATERIAL-Xisto  
QUADRADO-F10  
X-110cm  
Y-127cm  
Z-180cm

NECIV16  
OBJECTO-Conta de colar  
MATERIAL-Xisto  
QUADRADO-F10  
X-  
Y-  
Z-178cm

NECIV17  
OBJECTO-Conta de colar  
MATERIAL-Xisto  
QUADRADO-F12  
X-40cm  
Y-190cm  
Z-170cm

NECIV18  
OBJECTO-Conta de colar  
MATERIAL-Xisto  
QUADRADO-F11  
X-125cm  
Y-175cm  
Z-110cm

NECIV19  
OBJECTO-Conta de colar  
MATERIAL-Ambar  
QUADRADO-F10  
X-177cm  
Y-140cm  
Z-160cm

NECIV20  
OBJECTO-Ponta de seta  
MATERIAL-Sillex  
QUADRADO-F12  
X-20cm  
Y-180cm  
Z-170cm

NECIV21  
OBJECTO-Ponta de seta  
MATERIAL-Xisto jaspoide  
QUADRADO-F12  
X-40cm  
Y-190cm  
Z-170cm

NECIV22  
OBJECTO-Ponta de seta  
MATERIAL-Xisto ardosiario  
QUADRADO-F11  
X-  
Y-  
Z-170cm

NECIV23  
OBJECTO-Ponta de seta  
MATERIAL-Xisto ardosiario  
QUADRADO-F11  
X-130cm  
Y-14cm  
Z-160cm

NECIV24  
OBJECTO-Ponta de seta  
MATERIAL-Xisto ardosiario  
QUADRADO-F11  
X-76cm  
Y-145cm  
Z-165cm

N9CIV25  
OBJECTO-Fragmento de ponta de seta  
MATERIAL-Xisto jaspoide  
QUADRADO-F10  
X-125cm  
Y-177cm  
Z-192cm

N9CIV26  
OBJECTO-Ponta de seta  
MATERIAL-Xisto ardosiario  
QUADRADO-F10  
X-88cm  
Y-150cm  
Z-141cm

N9CIV27  
OBJECTO-Ponta de seta  
MATERIAL-Xisto ardosiario  
QUADRADO-F10  
X-  
Y-  
Z-150cm

N9CIV28  
OBJECTO-Ponta de seta  
MATERIAL-Silex  
QUADRADO-G12  
X-  
Y-  
Z-145cm

N9CIV29  
OBJECTO-Ponta de seta  
MATERIAL-Xisto ardosiario  
QUADRADO-F12  
X-  
Y-  
Z-148cm

N9CIV30  
OBJECTO-Ponta de seta  
MATERIAL-Xisto ardosiario  
QUADRADO-F10  
X-  
Y-  
Z-160cm

N9CIV31  
OBJECTO-Ponta de seta  
MATERIAL-Silex  
QUADRADO-F10  
X-100cm  
Y-160cm  
Z-170cm

N9CIV32  
OBJECTO-Fragmento de ponta de seta  
MATERIAL-Silex  
QUADRADO-G12  
X-  
Y-  
Z-155cm

N9CIV33  
OBJECTO-Fragmento de ponta de seta  
MATERIAL-Silex  
QUADRADO-G11  
X-  
Y-  
Z-165cm

N9CIV34  
OBJECTO-Fragmento de ponta de seta  
MATERIAL-Xisto jaspoide  
QUADRADO-F10  
X-  
Y-  
Z-160cm

N9CIV35  
OBJECTO-Fragmento de ponta de seta  
MATERIAL-Quartzo filoniano  
QUADRADO-G12  
X-  
Y-  
Z-150cm

N9CIV36  
OBJECTO-Ponta de seta  
MATERIAL-Silex  
QUADRADO-F10  
X-  
Y-  
Z-165cm

NECIV37  
OBJECTO-Ponta de seta  
MATERIAL-Sillex  
QUADRADO-F11  
X-25cm  
Y-175cm  
Z-170cm

NECIV38  
OBJECTO-Ponta de seta  
MATERIAL-Sillex  
QUADRADO-F11  
X-30cm  
Y-130cm  
Z-170cm

NECIV39  
OBJECTO-Ponta de seta  
MATERIAL-Sillex  
QUADRADO-F12  
X-12cm  
Y-136cm  
Z-170cm

NECIV40  
OBJECTO-Ponta de seta  
MATERIAL-Sillex  
QUADRADO-F12  
X-12cm  
Y-136cm  
Z-170cm

NECIV41  
OBJECTO-Ponta de seta  
MATERIAL-Sillex  
QUADRADO-F12  
X-20cm  
Y-180cm  
Z-170cm

NECIV42  
OBJECTO-Fragmento de ponta de seta  
MATERIAL-Quartzo filoniano  
QUADRADO-F12  
X-102cm  
Y-160cm  
Z-164cm

NECIV43  
OBJECTO-Ponta de seta  
MATERIAL-Sillex  
QUADRADO-F12  
X-132cm  
Y-149cm  
Z-163cm

NECIV44  
OBJECTO-Fragmento de ponta de seta (?)  
MATERIAL-Sillex  
QUADRADO-G12  
X-  
Y-  
Z-175cm

NECIV45  
OBJECTO-Lamina  
MATERIAL-Sillex  
QUADRADO-F12  
X-40cm  
Y-190cm  
Z-170cm

NECIV46  
OBJECTO-Fragmento de lamina  
MATERIAL-Sillex  
QUADRADO-F10  
X-133cm  
Y-150cm  
Z-182cm

NECIV47  
OBJECTO-Fragmento de lamina  
MATERIAL-Sillex  
QUADRADO-F10  
X-130cm  
Y-184cm  
Z-182cm

NECIV48  
OBJECTO-Fragmento de lamina  
MATERIAL-Sillex  
QUADRADO-F10  
X-190cm  
Y-170cm  
Z-195cm

N9CIV49  
 OBJECTO-Resto de talhe  
 MATERIAL-Sílex  
 QUADRADO-F12  
 X-102cm  
 Y-160cm  
 Z-163cm

N9CIV50  
 OBJECTO-Fragmento de lâmina  
 MATERIAL-Sílex  
 QUADRADO-F11  
 X-45cm  
 Y-145cm  
 Z-153cm

N9CIV51  
 OBJECTO-Fragmento de lâmina  
 MATERIAL-Sílex  
 QUADRADO-F11  
 X-45cm  
 Y-145cm  
 Z-153cm

N9CIV52  
 OBJECTO-Fragmento de lâmina  
 MATERIAL-Sílex  
 QUADRADO-F11  
 X-  
 Y-  
 Z-150cm

N9CIV53  
 OBJECTO-Fragmento de idolo-placa  
 MATERIAL-Xisto ardosiario  
 QUADRADO-F10  
 X-123cm  
 Y-125cm  
 Z-150cm

N9CIV54  
 OBJECTO-Idolo-placa  
 MATERIAL-Xisto  
 QUADRADO-F10  
 X-185cm  
 Y-170cm  
 Z-206cm

N9CIV55  
 OBJECTO-Idolo-placa  
 MATERIAL-Xisto  
 QUADRADO-F11  
 X-76cm  
 Y-145cm  
 Z-165cm

N9CIV56  
 OBJECTO-Idolo-placa  
 MATERIAL-Xisto  
 QUADRADO-F11  
 X-30cm  
 Y-130cm  
 Z-170cm

N9CIV57  
 OBJECTO-Taça de bordo recto  
 MATERIAL-Cerâmica  
 QUADRADO-F10  
 X-140cm  
 Y-160cm  
 Z-170cm

N9CIV58  
 OBJECTO-Fragmento de taça semi-esférica  
 MATERIAL-Cerâmica  
 QUADRADO-F11  
 X-125cm  
 Y-140cm  
 Z-180cm

N9CIV59  
 OBJECTO-Taça de bordo recto  
 MATERIAL-Cerâmica  
 QUADRADO-F11  
 X-154cm  
 Y-160cm  
 Z-165cm

N9CIV60  
 OBJECTO-Fragmento de taça carenada  
 MATERIAL-Cerâmica  
 QUADRADO-F11  
 X-85cm  
 Y-120cm  
 Z-182cm

NGCIV61  
OBJECTO-Fragmento de taça semi-esférica  
MATERIAL-Cerâmica  
QUADRADO-F12  
X-80cm  
Y-165cm  
Z-177cm

NGCIV62  
OBJECTO-Fragmento de taça semi-esférica  
MATERIAL-Cerâmica  
QUADRADO-F11  
X-147cm  
Y-150cm  
Z-160cm

NGCIV63  
OBJECTO-Fragmento de taça semi-esférica  
MATERIAL-Cerâmica  
QUADRADO-F10  
X-140cm  
Y-190cm  
Z-180cm

NGCIV64  
OBJECTO-Fragmento de taça de bordo recto  
MATERIAL-Cerâmica  
QUADRADO-F11  
X-80cm  
Y-170cm  
Z-170cm

NGCIV65  
OBJECTO-Fragmento de taça carenada  
MATERIAL-Cerâmica  
QUADRADO-F10  
X-20cm  
Y-150cm  
Z-160cm

NGCIV66  
OBJECTO-Fragmento de bordo  
MATERIAL-Cerâmica  
QUADRADO-F11  
X-  
Y-  
Z-  
Crivo

NGCIV67  
OBJECTO-Fragmento de taça carenada com decoração  
MATERIAL-Cerâmica  
QUADRADO-F11  
X-140cm  
Y-180cm  
Z-170cm

NGCIV70  
OBJECTO-Fragmento de taça de bordo recto  
MATERIAL-Cerâmica  
QUADRADO-F11  
X-  
Y-  
Z-

NGCIV72  
OBJECTO-Fragmento de bordo  
MATERIAL-Cerâmica  
QUADRADO-F11  
X-  
Y-  
Z-

NGCIV73  
OBJECTO-Fragmento de bordo  
MATERIAL-Cerâmica  
QUADRADO-F11  
X-  
Y-  
Z-

NGCIV77  
OBJECTO-Talão de machado  
MATERIAL-Anfibolite  
QUADRADO-(?)  
X-  
Y-  
Z-Superfície

N9  
OBJECTO-  
MATERIAL-  
QUADRADO-  
X-  
Y-  
Z-

ANTA  
do  
**GALHARDO**





ANTA DO GALHARDO

<p>                     NºG1                      OBJECTO-Geométrico                      MATERIAL-Sílex                      QUADRADO-(Câmara)                      X-                      Y-                      Z-                 </p>	<p>                     NºG7                      OBJECTO-Fragmento de taça carenada                      MATERIAL-Cerâmica                      QUADRADO-(Câmara)                      X-                      Y-                      Z-                 </p>
<p>                     NºG2                      OBJECTO-Fragmento de lâmina                      MATERIAL-Sílex                      QUADRADO-(Câmara)                      X-                      Y-                      Z-                 </p>	<p>                     NºG8                      OBJECTO-Taça carenada                      MATERIAL-Cerâmica                      QUADRADO-(Câmara)                      X-                      Y-                      Z-                 </p>
<p>                     NºG3                      OBJECTO-Geométrico                      MATERIAL-Sílex                      QUADRADO-(Câmara)                      X-                      Y-                      Z-                 </p>	<p>                     Nº                      OBJECTO-                      MATERIAL-                      QUADRADO-                      X-                      Y-                      Z-                 </p>
<p>                     NºG4                      OBJECTO-Fragmento de buril (?)                      MATERIAL-Sílex                      QUADRADO-(Câmara)                      X-                      Y-                      Z-                 </p>	<p>                     Nº                      OBJECTO-                      MATERIAL-                      QUADRADO-                      X-                      Y-                      Z-                 </p>
<p>                     NºG5                      OBJECTO-Ponta de seta                      MATERIAL-Sílex                      QUADRADO-(Câmara)                      X-                      Y-                      Z-                 </p>	<p>                     Nº                      OBJECTO-                      MATERIAL-                      QUADRADO-                      X-                      Y-                      Z-                 </p>
<p>                     NºG6                      OBJECTO-Conta de colar                      MATERIAL-Rocha verde                      QUADRADO-(Câmara)                      X-                      Y-                      Z-                 </p>	<p>                     Nº                      OBJECTO-                      MATERIAL-                      QUADRADO-                      X-                      Y-                      Z-                 </p>



ANTA  
dos  
**OLHEIROS**



ANTA DOS OLHEIROS

Nº009	OBJECTO-Taça	Nº015	OBJECTO-Fragmento de taça
MATERIAL-Cerâmica		MATERIAL-Cerâmica	
QUADRADO-(Câmara)		QUADRADO-(Câmara)	
X-		X-	
Y-		Y-	
Z-		Z-	
Nº010	OBJECTO-Taça	Nº017	OBJECTO-Fragmento de taça
MATERIAL-Cerâmica		MATERIAL-Cerâmica	
QUADRADO-(Câmara)		QUADRADO-(Câmara)	
X-		X-	
Y-		Y-	
Z-		Z-	
Nº011	OBJECTO-Fragmento de taça	Nº018	OBJECTO-Fragmento de vaso esférico
MATERIAL-Cerâmica		MATERIAL-Cerâmica	
QUADRADO-(Câmara)		QUADRADO-(Câmara)	
X-		X-	
Y-		Y-	
Z-		Z-	
Nº012	OBJECTO-Taça carenada	Nº019	OBJECTO-Fragmento de taça
MATERIAL-Cerâmica		MATERIAL-Cerâmica	
QUADRADO-(Câmara)		QUADRADO-(Câmara)	
X-		X-	
Y-		Y-	
Z-		Z-	
Nº013	OBJECTO-Fragmento de taça	Nº020	OBJECTO-Machado
MATERIAL-Cerâmica		MATERIAL-Anfibolite	
QUADRADO-(Câmara)		QUADRADO-(Câmara)	
X-		X-	
Y-		Y-	
Z-		Z-	
Nº014	OBJECTO-Fragmento de taça	Nº021	OBJECTO-Machado
MATERIAL-Cerâmica		MATERIAL-Anfibolite	
QUADRADO-(Câmara)		QUADRADO-(Câmara)	
X-		X-	
Y-		Y-	
Z-		Z-	

NG022  
OBJECTO-Machado  
MATERIAL-Anfibolite  
QUADRADO-(Câmara)  
X-  
Y-  
Z-

NG024  
OBJECTO-Bácullo  
MATERIAL-Xisto  
QUADRADO-(Câmara)  
X-  
Y-  
Z-

NG  
OBJECTO-  
MATERIAL-  
QUADRADO-  
X-  
Y-  
Z-

NG  
OBJECTO-  
MATERIAL-  
QUADRADO-  
X-  
Y-  
Z-

NG  
OBJECTO-  
MATERIAL-  
QUADRADO-  
X-  
Y-  
Z-

NG  
OBJECTO-  
MATERIAL-  
QUADRADO-  
X-  
Y-  
Z-

ANTA  
do  
PAI ANES





ANTA DO PAI ANES

N9PA1  
OBJECTO-Conta de colar  
MATERIAL-Xisto  
QUADRADO-?  
X-  
Y-  
Z-

N9PA2  
OBJECTO-Conta de colar  
MATERIAL-Xisto  
QUADRADO-?  
X-  
Y-  
Z-

N9PA3  
OBJECTO-Conta de colar  
MATERIAL-Xisto  
QUADRADO-?  
X-  
Y-  
Z-

N9PA4  
OBJECTO-Conta de colar  
MATERIAL-Xisto  
QUADRADO-?  
X-  
Y-  
Z-

N9PA5  
OBJECTO-Conta de colar  
MATERIAL-Xisto  
QUADRADO-?  
X-  
Y-  
Z-

N9PA6  
OBJECTO-Conta de colar  
MATERIAL-Xisto  
QUADRADO-?  
X-  
Y-  
Z-

N9PA7  
OBJECTO-Conta de colar  
MATERIAL-Xisto  
QUADRADO-?  
X-  
Y-  
Z-

N9PA8  
OBJECTO-Conta de colar  
MATERIAL-Xisto  
QUADRADO-?  
X-  
Y-  
Z-

N9PA9  
OBJECTO-Conta de colar  
MATERIAL-Xisto  
QUADRADO-?  
X-  
Y-  
Z-

N9PA10  
OBJECTO-Conta de colar  
MATERIAL-Xisto  
QUADRADO-?  
X-  
Y-  
Z-

N9PA11  
OBJECTO-Conta de colar  
MATERIAL-Xisto  
QUADRADO-?  
X-  
Y-  
Z-

N9PA12  
OBJECTO-Conta de colar  
MATERIAL-Xisto  
QUADRADO-?  
X-  
Y-  
Z-

NP0A13  
OBJECTO-Conta de colar  
MATERIAL-Xisto  
QUADRADO-?  
X-  
Y-  
Z-  
NP0A14  
OBJECTO-Conta de colar  
MATERIAL-Xisto  
QUADRADO-?  
X-  
Y-  
Z-  
NP0A15  
OBJECTO-Conta de colar  
MATERIAL-Xisto  
QUADRADO-?  
X-  
Y-  
Z-  
NP0A16  
OBJECTO-Conta de colar  
MATERIAL-Xisto  
QUADRADO-?  
X-  
Y-  
Z-  
NP0A17  
OBJECTO-Conta de colar  
MATERIAL-Xisto  
QUADRADO-?  
X-  
Y-  
Z-  
NP0A18  
OBJECTO-Conta de colar  
MATERIAL-Xisto  
QUADRADO-?  
X-  
Y-  
Z-

NP0A19  
OBJECTO-Conta de colar  
MATERIAL-Xisto  
QUADRADO-?  
X-  
Y-  
Z-

NP0A20  
OBJECTO-Conta de colar  
MATERIAL-Xisto  
QUADRADO-?  
X-  
Y-  
Z-

NP0A21  
OBJECTO-Conta de colar  
MATERIAL-Xisto  
QUADRADO-?  
X-  
Y-  
Z-

NP0A22  
OBJECTO-Fonta de seta  
MATERIAL-Silex  
QUADRADO-?  
X-  
Y-  
Z-

NP0A23  
OBJECTO-Fragmento de lamina  
MATERIAL-Silex  
QUADRADO-?  
X-  
Y-  
Z-

NP0A24  
OBJECTO-Geométrico  
MATERIAL-Silex  
QUADRADO-?  
X-  
Y-  
Z-

NoPA25  
 OBJECTO-Resto de talhe  
 MATERIAL-Sílex  
 QUADRADO-?  
 X-  
 Y-  
 Z-

NoPA29  
 OBJECTO-Taça semi-esférica  
 MATERIAL-Cerâmica  
 QUADRADO-?  
 X-  
 Y-  
 Z-

NoPA31  
 OBJECTO-Fragmento de taça  
 MATERIAL-Cerâmica  
 QUADRADO-?  
 X-  
 Y-  
 Z-

NoPA32  
 OBJECTO-Fragmento de taça carenada  
 MATERIAL-Cerâmica  
 QUADRADO-?  
 X-  
 Y-  
 Z-

NoPA33  
 OBJECTO-Fragmento de taça(?)  
 MATERIAL-Cerâmica  
 QUADRADO-?  
 X-  
 Y-  
 Z-

NoPA34  
 OBJECTO-Fragmento de taça carenada (?)  
 MATERIAL-Cerâmica  
 QUADRADO-?  
 X-  
 Y-  
 Z-

NoPA35  
 OBJECTO-Fragmento de taça  
 MATERIAL-Cerâmica  
 QUADRADO-?  
 X-  
 Y-  
 Z-

NoPA36  
 OBJECTO-Fragmento de taça (?)  
 MATERIAL-Cerâmica  
 QUADRADO-?  
 X-  
 Y-  
 Z-

NoPA37  
 OBJECTO-Fragmento de taça (?)  
 MATERIAL-Cerâmica  
 QUADRADO-?  
 X-  
 Y-  
 Z-

NoPA38  
 OBJECTO-Fragmento de taça  
 MATERIAL-Cerâmica  
 QUADRADO-?  
 X-  
 Y-  
 Z-

NoPA39  
 OBJECTO-Fragmento de taça carenada  
 MATERIAL-Cerâmica  
 QUADRADO-?  
 X-  
 Y-  
 Z-

NoPA41  
 OBJECTO-Fragmento de machado  
 MATERIAL-Anfibolite  
 QUADRADO-?  
 X-  
 Y-  
 Z-

NºPA45  
OBJECTO-Ponta de seta  
MATERIAL-Sillex  
QUADRADO-?

X-  
Y-  
Z-

Nº  
OBJECTO-  
MATERIAL-  
QUADRADO-  
X-  
Y-  
Z-

Nº  
OBJECTO-  
MATERIAL-  
QUADRADO-  
X-  
Y-  
Z-

Nº  
OBJECTO-  
MATERIAL-  
QUADRADO-  
X-  
Y-  
Z-

Nº  
OBJECTO-  
MATERIAL-  
QUADRADO-  
X-  
Y-  
Z-

Nº  
OBJECTO-  
MATERIAL-  
QUADRADO-  
X-  
Y-  
Z-

ANTA  
do  
**PORTO AIVADO**



NøPV36  
 OBJECTO-Fragmento de taça semi-esférica  
 MATERIAL-Cerâmica  
 QUADRADO-I11  
 X-  
 Y-  
 Z-2,22cm

NøPV40  
 OBJECTO-Fragmento de cerâmica perfurada  
 MATERIAL-Cerâmica  
 QUADRADO-H12  
 X-  
 Y-  
 Z-216cm

NøPV43  
 OBJECTO-  
 MATERIAL-Cerâmica  
 QUADRADO-  
 X-  
 Y-  
 Z-

NøPV45  
 OBJECTO-Fragmento de taça  
 MATERIAL-Cerâmica  
 QUADRADO-G12  
 X-  
 Y-  
 Z-233cm

NøPV49  
 OBJECTO-Taça semi-esférica  
 MATERIAL-Cerâmica  
 QUADRADO-I12  
 X-60cm  
 Y-10cm  
 Z-234cm

NøPV50  
 OBJECTO-Fragmento de taça  
 MATERIAL-Cerâmica  
 QUADRADO-I12  
 X-  
 Y-  
 Z-235cm

NøPV54  
 OBJECTO-Fragmento de taça  
 MATERIAL-Cerâmica  
 QUADRADO-?  
 X-  
 Y-  
 Z-  
 Crivo

NøPV60  
 OBJECTO-Fragmento de bordo de vaso(?)  
 MATERIAL-Cerâmica  
 QUADRADO-I12  
 X-  
 Y-  
 Z-Superfície

NøPV62  
 OBJECTO-Fragmento de taça  
 MATERIAL-Cerâmica  
 QUADRADO-I12  
 X-  
 Y-  
 Z-Superfície

NøPV69  
 OBJECTO-Fragmento de pote (?)  
 MATERIAL-Cerâmica  
 QUADRADO-I12  
 X-  
 Y-  
 Z-Superfície

NøPV77  
 OBJECTO-Fragmento de taça  
 MATERIAL-Cerâmica  
 QUADRADO-I11  
 X-  
 Y-  
 Z-Superfície

NøPV86  
 OBJECTO-Fragmento de taça  
 MATERIAL-Cerâmica  
 QUADRADO-?  
 X-  
 Y-  
 Z-Superfície



NGPV98  
OBJETO-Fragmento de taça carenada (?)  
MATERIAL-Cerâmica  
QUADRADO-G12  
X-  
Y-  
Z-249cm

NGPV99  
OBJETO-Fragmento de bordo de vaso(?) com decoração  
MATERIAL-Cerâmica  
QUADRADO-I11  
X-23cm  
Y-45cm  
Z-233cm

NGPV100  
OBJETO-Taça semi-esférica  
MATERIAL-Cerâmica  
QUADRADO-I12  
X-70cm  
Y-84cm  
Z-230cm

NGPV101  
OBJETO-Fragmento de taça semi-esférica  
MATERIAL-Cerâmica  
QUADRADO-H13  
X-  
Y-  
Z-245cm

NGPV104  
OBJETO-Fragmento de taça semi-esférica  
MATERIAL-Cerâmica  
QUADRADO-H12  
X-  
Y-  
Z-214cm

NGPV105  
OBJETO-Fragmento de taça semi-esférica  
MATERIAL-Cerâmica  
QUADRADO-H12  
X-  
Y-  
Z-243cm

NGPV106  
OBJETO-Fragmento de taça carenada  
MATERIAL-Cerâmica  
QUADRADO-H12  
X-  
Y-  
Z-237cm

NGPV110  
OBJETO-Fragmento de bordo de taça(?)  
MATERIAL-Cerâmica  
QUADRADO-H12  
X-  
Y-  
Z-Superfície

NGPV112  
OBJETO-Fragmento de taça carenada (?)  
MATERIAL-Cerâmica  
QUADRADO-G11  
X-  
Y-  
Z-193cm

NGPV114  
OBJETO-Fragmento de bordo de pote (?)  
MATERIAL-Cerâmica  
QUADRADO-I11  
X-31cm  
Y-158cm  
Z-230cm

NGPV132  
OBJETO-Fragmento de taça  
MATERIAL-Cerâmica  
QUADRADO-I11  
X-  
Y-  
Z-232cm

NGPV136  
OBJETO-Fragmento de taça  
MATERIAL-Cerâmica  
QUADRADO-I11  
X-  
Y-  
Z-Superfície

NpV148  
 OBJECTO-Fragmento de bordo de taça (?)  
 MATERIAL-Cerâmica  
 QUADRADO-I11  
 X-  
 Y-  
 Z-Superfície

NpV149  
 OBJECTO-Fragmento de taça  
 MATERIAL-Cerâmica  
 QUADRADO-G11  
 X-  
 Y-  
 Z-193cm

NpV163  
 OBJECTO-Fragmento de taça de fundo plano (?)  
 MATERIAL-Cerâmica  
 QUADRADO-G11  
 X-  
 Y-  
 Z-200cm

NpV164  
 OBJECTO-Ponta de seta  
 MATERIAL-Xisto ardosoiano  
 QUADRADO-G12  
 X-  
 Y-  
 Z-243cm

NpV168  
 OBJECTO-fragmento de bordo (?)  
 MATERIAL-Cerâmica  
 QUADRADO-G11  
 X-  
 Y-  
 Z-  
 Crivo

NpV186  
 OBJECTO-Ponta de seta  
 MATERIAL-Quartzó hialino  
 QUADRADO-H12  
 X-  
 Y-  
 Z-  
 Crivo

NpV188  
 OBJECTO-Cristal  
 MATERIAL-Quartzó filoniano  
 QUADRADO-G11  
 X-  
 Y-  
 Z-240cm

NpV189  
 OBJECTO-Ponta de seta (?)  
 MATERIAL-Sílex  
 QUADRADO-I11  
 X-  
 Y-  
 Z-218cm

NpV190  
 OBJECTO-Resto de talhe  
 MATERIAL-Sílex  
 QUADRADO-G11  
 X-  
 Y-  
 Z-227

NpV191  
 OBJECTO-Resto de talhe  
 MATERIAL-Sílex  
 QUADRADO-G11  
 X-  
 Y-  
 Z-  
 Crivo

NpV192  
 OBJECTO-Lâmina  
 MATERIAL-Sílex  
 QUADRADO-I11  
 X-30cm  
 Y-143cm  
 Z-200cm

NpV193  
 OBJECTO-Geométrico (?)  
 MATERIAL-Sílex  
 QUADRADO-G11  
 X-  
 Y-  
 Z-  
 Crivo

N9PV195  
 OBJETO-Ponta de seta  
 MATERIAL-Xisto Jaspoido  
 QUADRADO-611  
 X-  
 Y-  
 Z-  
 Crivo  
 N9PV196  
 OBJETO-Cristal  
 MATERIAL-Turmalina  
 QUADRADO-J11  
 X-  
 Y-  
 Z-245cm  
 N9PV197  
 OBJETO-Fragmento de idolo-placa  
 MATERIAL-Xisto ardosiario  
 QUADRADO-H12  
 X-  
 Y-  
 Z-214cm  
 N9PV206  
 OBJETO-Machado  
 MATERIAL-Anfibolite  
 QUADRADO-I11  
 X-115cm  
 Y-200cm  
 Z-209cm  
 N9PV207  
 OBJETO-Machado  
 MATERIAL-Anfibolite  
 QUADRADO-I11  
 X-28cm  
 Y-131cm  
 Z-221cm  
 N9PV214  
 OBJETO-Percutor  
 MATERIAL-Granito  
 QUADRADO-?  
 X-  
 Y-  
 Z-Superficie

N9PV218  
 OBJETO-Fragmento de elemento de mó (movente)  
 MATERIAL-Granito  
 QUADRADO-  
 X-  
 Y-  
 Z-  
 N9PV219  
 OBJETO-Fragmento de elemento de mó (movente)  
 MATERIAL-Granito  
 QUADRADO-I12  
 X-5cm  
 Y-7cm  
 Z-2,14cm  
 N9PV221  
 OBJETO-Fragmento de elemento de mó (dormente)  
 MATERIAL-Granito  
 QUADRADO-  
 X-  
 Y-  
 Z-  
 N9PV222  
 OBJETO-Fragmento de elemento de mó (dormente)  
 MATERIAL-Granito  
 QUADRADO-I11  
 X-  
 Y-  
 Z-Superficie  
 N9  
 OBJETO-  
 MATERIAL-  
 QUADRADO-  
 X-  
 Y-  
 Z-  
 N9  
 OBJETO-  
 MATERIAL-  
 QUADRADO-  
 X-  
 Y-  
 Z-

ANTA  
do  
**SOBRAL**



NºS1  
OBJECTO-Colher  
MATERIAL-Cerâmica  
QUADRADO-(Câmara)  
X-  
Y-  
Z-

NºS2  
OBJECTO-Machado  
MATERIAL-Anfibolite  
QUADRADO-(Câmara)  
X-  
Y-  
Z-



ANTA  
da  
**TAPADA DE MATOS**





ANTA DA TAPADA DOS MATOS

NotM1  
 OBJECTO-Taça carenada com mamilos  
 MATERIAL-Cerâmica  
 QUADRADO-? (Corredor)  
 X-  
 Y-  
 Z-

NotM2  
 OBJECTO-Taça carenada  
 MATERIAL-Cerâmica  
 QUADRADO-? (Corredor)  
 X-  
 Y-  
 Z-

NotM3  
 OBJECTO-Taça semi-esférica  
 MATERIAL-Cerâmica  
 QUADRADO-? (Corredor)  
 X-  
 Y-  
 Z-

NotM4  
 OBJECTO-Vaso acampanado  
 MATERIAL-Cerâmica  
 QUADRADO-? (Corredor)  
 X-  
 Y-  
 Z-

NotM5  
 OBJECTO-Taça carenada  
 MATERIAL-Cerâmica  
 QUADRADO-? (Corredor)  
 X-  
 Y-  
 Z-

NotM6  
 OBJECTO-Fragmento de taça  
 MATERIAL-Cerâmica  
 QUADRADO-? (Corredor)  
 X-  
 Y-  
 Z-

NotM7  
 OBJECTO-Taça semi-esférica  
 MATERIAL-Cerâmica  
 QUADRADO-? (Corredor)  
 X-  
 Y-  
 Z-

NotM8  
 OBJECTO-Fragmento de taça (?)  
 MATERIAL-Cerâmica  
 QUADRADO-? (Corredor)  
 X-  
 Y-  
 Z-

NotM9  
 OBJECTO-Fragmento de taça  
 MATERIAL-Cerâmica  
 QUADRADO-? (Corredor)  
 X-  
 Y-  
 Z-

NotM10  
 OBJECTO-Fragmento de taça  
 MATERIAL-Cerâmica  
 QUADRADO-? (Corredor)  
 X-  
 Y-  
 Z-

NotM12  
 OBJECTO-Fragmento de taça  
 MATERIAL-Cerâmica  
 QUADRADO-? (Corredor)  
 X-  
 Y-  
 Z-

NotM13  
 OBJECTO-Fragmento de taça  
 MATERIAL-Cerâmica  
 QUADRADO-? (Corredor)  
 X-  
 Y-  
 Z-

NETM14  
OBJECTO-Taca carenada com mamilos  
MATERIAL-Ceramica  
QUADRADO-? (Corredor)  
X-  
Y-  
Z-

NETM15  
OBJECTO-Fragmento de lâmina  
MATERIAL-Silex  
QUADRADO-? (Corredor)  
X-  
Y-  
Z-

NETM17  
OBJECTO-Fragmento de lâmina  
MATERIAL-Silex  
QUADRADO-? (Corredor)  
X-  
Y-  
Z-

NETM18  
OBJECTO-Fragmento de lâmina  
MATERIAL-Silex  
QUADRADO-? (Corredor)  
X-  
Y-  
Z-

NETM19  
OBJECTO-Fragmento de lâmina  
MATERIAL-Silex  
QUADRADO-? (Corredor)  
X-  
Y-  
Z-

NETM20  
OBJECTO-Fragmento de lâmina (?)  
MATERIAL-Silex  
QUADRADO-? (Corredor)  
X-  
Y-  
Z-

NETM21  
OBJECTO-Fragmento de lâmina  
MATERIAL-Silex  
QUADRADO-? (Corredor)  
X-  
Y-  
Z-

NETM22  
OBJECTO-Fragmento de lâmina  
MATERIAL-Silex  
QUADRADO-? (Corredor)  
X-  
Y-  
Z-

NETM23  
OBJECTO-Fragmento de lâmina  
MATERIAL-Xisto Jaspide  
QUADRADO-? (Corredor)  
X-  
Y-  
Z-

NETM24  
OBJECTO-Fragmento de lâmina  
MATERIAL-Silex  
QUADRADO-? (Corredor)  
X-  
Y-  
Z-

NETM25  
OBJECTO-Fragmento de lâmina  
MATERIAL-Silex  
QUADRADO-? (Corredor)  
X-  
Y-  
Z-

NETM26  
OBJECTO-Resto de talhe  
MATERIAL-Silex  
QUADRADO-? (Corredor)  
X-  
Y-  
Z-

NoTM27  
 OBJETO-Fragmento de lámina  
 MATERIAL-Sílex  
 CUADRADO-? (Corredor)  
 X-  
 Y-  
 Z-

NoTM28  
 OBJETO-Fragmento de lámina  
 MATERIAL-Sílex  
 CUADRADO-? (Corredor)  
 X-  
 Y-  
 Z-

NoTM29  
 OBJETO-Fragmento de lámina (?)  
 MATERIAL-Sílex  
 CUADRADO-? (Corredor)  
 X-  
 Y-  
 Z-

NoTM30  
 OBJETO-Fragmento de lámina reutilizado (?)  
 MATERIAL-Sílex  
 CUADRADO-? (Corredor)  
 X-  
 Y-  
 Z-

NoTM31  
 OBJETO-Fragmento de lámina reutilizado (?)  
 MATERIAL-Sílex  
 CUADRADO-? (Corredor)  
 X-  
 Y-  
 Z-

NoTM32  
 OBJETO-Fragmento de lámina  
 MATERIAL-Sílex  
 CUADRADO-? (Corredor)  
 X-  
 Y-  
 Z-

NoTM33  
 OBJETO-Fragmento de lámina  
 MATERIAL-Sílex  
 CUADRADO-? (Corredor)  
 X-  
 Y-  
 Z-

NoTM34  
 OBJETO-Fragmento de lámina  
 MATERIAL-Sílex  
 CUADRADO-? (Corredor)  
 X-  
 Y-  
 Z-

NoTM35  
 OBJETO-Fragmento de lámina reutilizado (?)  
 MATERIAL-Sílex  
 CUADRADO-? (Corredor)  
 X-  
 Y-  
 Z-

NoTM36  
 OBJETO-Fragmento de Lámina  
 MATERIAL-Sílex  
 CUADRADO-? (Corredor)  
 X-  
 Y-  
 Z-

NoTM37  
 OBJETO-Fragmento de lámina  
 MATERIAL-Sílex  
 CUADRADO-? (Corredor)  
 X-  
 Y-  
 Z-

NoTM38  
 OBJETO-Fragmento de lámina  
 MATERIAL-Sílex  
 CUADRADO-? (Corredor)  
 X-  
 Y-  
 Z-

NOTM39  
OBJECTO-Fragmento de lâmina  
MATERIAL-Silex  
QUADRADO-? (Corredor)  
X-  
Y-  
Z-

NOTM40  
OBJECTO-Geométrico  
MATERIAL-Silex  
QUADRADO-? (Corredor)  
X-  
Y-  
Z-

NOTM41  
OBJECTO-Geométrico (?)  
MATERIAL-Silex  
QUADRADO-? (Corredor)  
X-  
Y-  
Z-

NOTM42  
OBJECTO-Fragmento de lâmina  
MATERIAL-Silex  
QUADRADO-? (Corredor)  
X-  
Y-  
Z-

NOTM43  
OBJECTO-Fragmento de lâmina (?)  
MATERIAL-Silex  
QUADRADO-? (Corredor)  
X-  
Y-  
Z-

NOTM45  
OBJECTO-Fragmento de lâmina  
MATERIAL-Silex  
QUADRADO-? (Corredor)  
X-  
Y-  
Z-

NOTM46  
OBJECTO-Fragmento de lâmina (?)  
MATERIAL-Silex  
QUADRADO-? (Corredor)  
X-  
Y-  
Z-

NOTM47  
OBJECTO-Fragmento de lâmina  
MATERIAL-Silex  
QUADRADO-? (Corredor)  
X-  
Y-  
Z-

NOTM48  
OBJECTO-Geométrico (?)  
MATERIAL-Silex  
QUADRADO-? (Corredor)  
X-  
Y-  
Z-

NOTM49  
OBJECTO-Fragmento de lâmina  
MATERIAL-Silex  
QUADRADO-? (Corredor)  
X-  
Y-  
Z-

NOTM50  
OBJECTO-Fragmento de lâmina (?)  
MATERIAL-Silex  
QUADRADO-? (Corredor)  
X-  
Y-  
Z-

NOTM51  
OBJECTO-Fragmento de lâmina  
MATERIAL-Silex  
QUADRADO-? (Corredor)  
X-  
Y-  
Z-

NOTM52  
OBJECTO-Fragmento de lámina  
MATERIAL-Silex  
QUADRADO-? (Corredor)  
X-  
Y-  
Z-

NOTM53  
OBJECTO-Fragmento de lamela  
MATERIAL-Silex  
QUADRADO-? (Corredor)  
X-  
Y-  
Z-

NOTM54  
OBJECTO-Fragmento de lámina (?)  
MATERIAL-Silex  
QUADRADO-? (Corredor)  
X-  
Y-  
Z-

NOTM55  
OBJECTO-Fragmento de lámina (?)  
MATERIAL-Silex  
QUADRADO-? (Corredor)  
X-  
Y-  
Z-

NOTM56  
OBJECTO-Fragmento de lámina (?)  
MATERIAL-Silex  
QUADRADO-? (Corredor)  
X-  
Y-  
Z-

NOTM57  
OBJECTO-Fragmento de lamela  
MATERIAL-Silex  
QUADRADO-? (Corredor)  
X-  
Y-  
Z-

NOTM58  
OBJECTO-Geométrico (?)  
MATERIAL-Silex  
QUADRADO-? (Corredor)  
X-  
Y-  
Z-

NOTM59  
OBJECTO-Fragmento de lámina (?)  
MATERIAL-Silex  
QUADRADO-? (Corredor)  
X-  
Y-  
Z-

NOTM60  
OBJECTO-Fragmento de lámina  
MATERIAL-Silex  
QUADRADO-? (Corredor)  
X-  
Y-  
Z-

NOTM61  
OBJECTO-Fragmento de lámina  
MATERIAL-Silex  
QUADRADO-? (Corredor)  
X-  
Y-  
Z-

NOTM62  
OBJECTO-Geométrico  
MATERIAL-Silex  
QUADRADO-? (Corredor)  
X-  
Y-  
Z-

NOTM63  
OBJECTO-Fragmento de lámina  
MATERIAL-Silex  
QUADRADO-? (Corredor)  
X-  
Y-  
Z-

NOTM64  
OBJECTO-Fragmento de lâmina  
MATERIAL-Silex  
QUADRADO-? (Corredor)  
X-  
Y-  
Z-

NOTM65  
OBJECTO-Fragmento de lâmina  
MATERIAL-Silex  
QUADRADO-? (Corredor)  
X-  
Y-  
Z-

NOTM66  
OBJECTO-Fragmento de lâmina  
MATERIAL-Silex  
QUADRADO-? (Corredor)  
X-  
Y-  
Z-

NOTM68  
OBJECTO-Geométrico  
MATERIAL-Silex  
QUADRADO-? (Corredor)  
X-  
Y-  
Z-

NOTM69  
OBJECTO-Fragmento de lâmina  
MATERIAL-Silex  
QUADRADO-? (Corredor)  
X-  
Y-  
Z-

NOTM70  
OBJECTO-Fragmento de lâmina  
MATERIAL-Silex  
QUADRADO-? (Corredor)  
X-  
Y-  
Z-

NOTM71  
OBJECTO-Fragmento de lâmina  
MATERIAL-Silex  
QUADRADO-? (Corredor)  
X-  
Y-  
Z-

NOTM72  
OBJECTO-Lâmina  
MATERIAL-Silex  
QUADRADO-? (Corredor)  
X-  
Y-  
Z-

NOTM73  
OBJECTO-Fragmento de lâmina  
MATERIAL-Silex  
QUADRADO-? (Corredor)  
X-  
Y-  
Z-

NOTM74  
OBJECTO-Lâmina  
MATERIAL-Silex  
QUADRADO-? (Corredor)  
X-  
Y-  
Z-

NOTM75  
OBJECTO-Lâmina  
MATERIAL-Silex  
QUADRADO-? (Corredor)  
X-  
Y-  
Z-

NOTM76  
OBJECTO-Fragmento de lâmina  
MATERIAL-Silex  
QUADRADO-? (Corredor)  
X-  
Y-  
Z-

NotM77  
OBJETO-Fragmento de lámina  
MATERIAL-Silex  
QUADRADO-? (Corredor)  
X-  
Y-  
Z-

Not78  
OBJETO-Lámina  
MATERIAL-Silex  
QUADRADO-? (Corredor)  
X-  
Y-  
Z-

NotM79  
OBJETO-Fragmento de lámina  
MATERIAL-Silex  
QUADRADO-? (Corredor)  
X-  
Y-  
Z-

NotM80  
OBJETO-Lámina  
MATERIAL-Silex  
QUADRADO-? (Corredor)  
X-  
Y-  
Z-

NotM81  
OBJETO-Lámina  
MATERIAL-Silex  
QUADRADO-? (Corredor)  
X-  
Y-  
Z-

NotM82  
OBJETO-Fragmento de lámina  
MATERIAL-Silex  
QUADRADO-? (Corredor)  
X-  
Y-  
Z-

NotM83  
OBJETO-Fragmento de lámina  
MATERIAL-Silex  
QUADRADO-? (Corredor)  
X-  
Y-  
Z-

NotM84  
OBJETO-Fragmento de lámina  
MATERIAL-Silex  
QUADRADO-? (Corredor)  
X-  
Y-  
Z-

NotM85  
OBJETO-Fragmento de lámina  
MATERIAL-Silex  
QUADRADO-? (Corredor)  
X-  
Y-  
Z-

NotM86  
OBJETO-Fragmento de lámina  
MATERIAL-Silex  
QUADRADO-? (Corredor)  
X-  
Y-  
Z-

NotM87  
OBJETO-Fragmento de lámina  
MATERIAL-Silex  
QUADRADO-? (Corredor)  
X-  
Y-  
Z-

NotM88  
OBJETO-Fragmento de lámina  
MATERIAL-Silex  
QUADRADO-? (Corredor)  
X-  
Y-  
Z-



NETM89  
OBJETO-Fragmento de lâmina  
MATERIAL-Silex  
QUADRADO-? (Corredor)  
X-  
Y-  
Z-

NETM90  
OBJETO-Fragmento de lâmina  
MATERIAL-Silex  
QUADRADO-? (Corredor)  
X-  
Y-  
Z-

NETM92  
OBJETO-Fragmento de lâmina reutilizado (?)  
MATERIAL-Silex  
QUADRADO-? (Corredor)  
X-  
Y-  
Z-

NETM93  
OBJETO-Fragmento de lâmina  
MATERIAL-Silex  
QUADRADO-? (Corredor)  
X-  
Y-  
Z-

NETM94  
OBJETO-Fragmento de lâmina  
MATERIAL-Silex  
QUADRADO-? (Corredor)  
X-  
Y-  
Z-

NETM95  
OBJETO-Lâmina  
MATERIAL-Silex  
QUADRADO-? (Corredor)  
X-  
Y-  
Z-

NETM86  
OBJETO-Fragmento de lâmina  
MATERIAL-Silex  
QUADRADO-? (Corredor)  
X-  
Y-  
Z-

NETM87  
OBJETO-Fragmento de lâmina  
MATERIAL-Silex  
QUADRADO-? (Corredor)  
X-  
Y-  
Z-

NETM98  
OBJETO-Fragmento de lâmina  
MATERIAL-Silex  
QUADRADO-? (Corredor)  
X-  
Y-  
Z-

NETM99  
OBJETO-Fragmento de lâmina  
MATERIAL-Silex  
QUADRADO-? (Corredor)  
X-  
Y-  
Z-

NETM100  
OBJETO-Fragmento de lâmina  
MATERIAL-Silex  
QUADRADO-? (Corredor)  
X-  
Y-  
Z-

NETM101  
OBJETO-Fragmento de lâmina  
MATERIAL-Silex  
QUADRADO-? (Corredor)  
X-  
Y-  
Z-

NOTM109  
OBJECTO-Ponta de seta  
MATERIAL-Quartzo filoniano  
QUADRADO-? (Corredor)  
X-  
Y-  
Z-

NOTM110  
OBJECTO-Ponta de seta  
MATERIAL-Silex  
QUADRADO-? (Corredor)  
X-  
Y-  
Z-

NOTM111  
OBJECTO-Ponta de seta  
MATERIAL-Xisto jaspoide  
QUADRADO-? (Corredor)  
X-  
Y-  
Z-

NOTM112  
OBJECTO-Ponta de seta  
MATERIAL-Silex  
QUADRADO-? (Corredor)  
X-  
Y-  
Z-

NOTM113  
OBJECTO-Ponta de seta  
MATERIAL-Quartzo hialino  
QUADRADO-? (Corredor)  
X-  
Y-  
Z-

NOTM114  
OBJECTO-Ponta de seta  
MATERIAL-Silex  
QUADRADO-? (Corredor)  
X-  
Y-  
Z-

NOTM103  
OBJECTO-Fragmento de lâmina  
MATERIAL-Silex  
QUADRADO-? (Corredor)  
X-  
Y-  
Z-

NOTM104  
OBJECTO-Fragmento de lâmina  
MATERIAL-Silex  
QUADRADO-? (Corredor)  
X-  
Y-  
Z-

NOTM105  
OBJECTO-Resto de talhe  
MATERIAL-Silex  
QUADRADO-? (Corredor)  
X-  
Y-  
Z-

NOTM106  
OBJECTO-Lâmina  
MATERIAL-Silex  
QUADRADO-? (Corredor)  
X-  
Y-  
Z-

NOTM107  
OBJECTO-Ponta de seta  
MATERIAL-Silex  
QUADRADO-? (Corredor)  
X-  
Y-  
Z-

NOTM108  
OBJECTO-Ponta de seta(?)  
MATERIAL-Quartzo filoniano  
QUADRADO-? (Corredor)  
X-  
Y-  
Z-

NGTM115  
OBJECTO-Ponta de seta  
MATERIAL-Sillex  
QUADRADO-? (Corredor)  
X-  
Y-  
Z-

NGTM116  
OBJECTO-Ponta de seta  
MATERIAL-Sillex  
QUADRADO-? (Corredor)  
X-  
Y-  
Z-

NGTM117  
OBJECTO-Ponta de seta  
MATERIAL-Sillex  
QUADRADO-? (Corredor)  
X-  
Y-  
Z-

NGTM118  
OBJECTO-Ponta de seta  
MATERIAL-Quartzo filoniano  
QUADRADO-? (Corredor)  
X-  
Y-  
Z-

NGTM119  
OBJECTO-Ponta de seta  
MATERIAL-Sillex  
QUADRADO-? (Corredor)  
X-  
Y-  
Z-

NGTM120  
OBJECTO-Fragmento de ponta de seta  
MATERIAL-Sillex  
QUADRADO-? (Corredor)  
X-  
Y-  
Z-

NGTM121  
OBJECTO-Ponta de seta  
MATERIAL-Sillex  
QUADRADO-? (Corredor)  
X-  
Y-  
Z-

NGTM122  
OBJECTO-Ponta de seta  
MATERIAL-Sillex  
QUADRADO-? (Corredor)  
X-  
Y-  
Z-

NGTM123  
OBJECTO-Ponta de seta  
MATERIAL-Sillex  
QUADRADO-? (Corredor)  
X-  
Y-  
Z-

NGTM124  
OBJECTO-Ponta de seta  
MATERIAL-Sillex  
QUADRADO-? (Corredor)  
X-  
Y-  
Z-

NGTM125  
OBJECTO-Ponta de seta  
MATERIAL-Sillex  
QUADRADO-? (Corredor)  
X-  
Y-  
Z-

NGTM126  
OBJECTO-Ponta de seta  
MATERIAL-Sillex  
QUADRADO-? (Corredor)  
X-  
Y-  
Z-

NotM127  
OBJECTO-Ponta de seta  
MATERIAL-Silex  
QUADRADO-? (Corredor)  
X-  
Y-  
Z-

NotM128  
OBJECTO-Fragmento de ponta de seta (?)  
MATERIAL-Quartzo filoniano  
QUADRADO-? (Corredor)  
X-  
Y-  
Z-

NotM129  
OBJECTO-Ponta de seta  
MATERIAL-Silex  
QUADRADO-? (Corredor)  
X-  
Y-  
Z-

NotM130  
OBJECTO-Ponta de seta  
MATERIAL-Quartzo hialino  
QUADRADO-? (Corredor)  
X-  
Y-  
Z-

NotM131  
OBJECTO-Ponta de seta  
MATERIAL-Quartzo filoniano  
QUADRADO-? (Corredor)  
X-  
Y-  
Z-

NotM132  
OBJECTO-Ponta de seta  
MATERIAL-Silex (cortex)  
QUADRADO-? (Corredor)  
X-  
Y-  
Z-

NotM133  
OBJECTO-Ponta de seta  
MATERIAL-Silex  
QUADRADO-? (Corredor)  
X-  
Y-  
Z-

NotM134  
OBJECTO-Ponta de seta  
MATERIAL-Silex  
QUADRADO-? (Corredor)  
X-  
Y-  
Z-

NotM135  
OBJECTO-Ponta de seta  
MATERIAL-Quartzo filoniano  
QUADRADO-? (Corredor)  
X-  
Y-  
Z-

NotM136  
OBJECTO-Ponta de seta  
MATERIAL-Silex  
QUADRADO-? (Corredor)  
X-  
Y-  
Z-

NotM137  
OBJECTO-Ponta de seta  
MATERIAL-Silex  
QUADRADO-? (Corredor)  
X-  
Y-  
Z-

NotM138  
OBJECTO-Fragmento de ponta de seta  
MATERIAL-Silex  
QUADRADO-? (Corredor)  
X-  
Y-  
Z-

NOTM139  
OBJECTO-Ponta de seta  
MATERIAL-Sillex  
QUADRADO-? (Corredor)  
X-  
Y-  
Z-

NOTM140  
OBJECTO-Ponta de seta  
MATERIAL-Quartzo filoniano  
QUADRADO-? (Corredor)  
X-  
Y-  
Z-

NOTM141  
OBJECTO-Ponta de seta  
MATERIAL-Sillex  
QUADRADO-? (Corredor)  
X-  
Y-  
Z-

NOTM142  
OBJECTO-Ponta de seta  
MATERIAL-Sillex  
QUADRADO-? (Corredor)  
X-  
Y-  
Z-

NOTM143  
OBJECTO-Ponta de seta  
MATERIAL-Sillex  
QUADRADO-? (Corredor)  
X-  
Y-  
Z-

NOTM144  
OBJECTO-Ponta de seta  
MATERIAL-Sillex  
QUADRADO-? (Corredor)  
X-  
Y-  
Z-

NOTM145  
OBJECTO-Ponta de seta  
MATERIAL-Sillex  
QUADRADO-? (Corredor)  
X-  
Y-  
Z-

NOTM146  
OBJECTO-Ponta de seta  
MATERIAL-Sillex  
QUADRADO-? (Corredor)  
X-  
Y-  
Z-

NOTM147  
OBJECTO-Ponta de seta  
MATERIAL-Sillex  
QUADRADO-? (Corredor)  
X-  
Y-  
Z-

NOTM148  
OBJECTO-Ponta de seta  
MATERIAL-Quartzo hialino  
QUADRADO-? (Corredor)  
X-  
Y-  
Z-

NOTM149  
OBJECTO-Ponta de seta  
MATERIAL-Sillex  
QUADRADO-? (Corredor)  
X-  
Y-  
Z-

NOTM150  
OBJECTO-Ponta de seta  
MATERIAL-Quartzo filoniano  
QUADRADO-? (Corredor)  
X-  
Y-  
Z-

NoTM151  
 OBJECTO-Ponta de seta  
 MATERIAL-Silex  
 QUADRADO-? (Corredor)  
 X-  
 Y-  
 Z-

NoTM152  
 OBJECTO-Ponta de seta  
 MATERIAL-Quartzo filoniano  
 QUADRADO-? (Corredor)  
 X-  
 Y-  
 Z-

NoTM153  
 OBJECTO-Ponta de seta  
 MATERIAL-Quartzo filoniano  
 QUADRADO-? (Corredor)  
 X-  
 Y-  
 Z-

NoTM154  
 OBJECTO-Ponta de seta  
 MATERIAL-Silex  
 QUADRADO-? (Corredor)  
 X-  
 Y-  
 Z-

NoTM155  
 OBJECTO-Ponta de seta  
 MATERIAL-Silex  
 QUADRADO-? (Corredor)  
 X-  
 Y-  
 Z-

NoTM156  
 OBJECTO-Ponta de seta  
 MATERIAL-Silex  
 QUADRADO-? (Corredor)  
 X-  
 Y-  
 Z-

NoTM157  
 OBJECTO-Ponta de seta  
 MATERIAL-Quartzo filoniano  
 QUADRADO-? (Corredor)  
 X-  
 Y-  
 Z-

NoTM158  
 OBJECTO-Fragmento de ponta de seta  
 MATERIAL-Silex  
 QUADRADO-? (Corredor)  
 X-  
 Y-  
 Z-

NoTM159  
 OBJECTO-Ponta de seta  
 MATERIAL-Silex  
 QUADRADO-? (Corredor)  
 X-  
 Y-  
 Z-

NoTM160  
 OBJECTO-Ponta de seta  
 MATERIAL-Silex  
 QUADRADO-? (Corredor)  
 X-  
 Y-  
 Z-

NoTM161  
 OBJECTO-Ponta de seta  
 MATERIAL-Silex  
 QUADRADO-? (Corredor)  
 X-  
 Y-  
 Z-

NoTM162  
 OBJECTO-Ponta de seta  
 MATERIAL-Silex  
 QUADRADO-? (Corredor)  
 X-  
 Y-  
 Z-

NOTM163  
OBJECTO-Ponta de seta  
MATERIAL-Silex  
QUADRADO-? (Corredor)  
X-  
Y-  
Z-

NOTM164  
OBJECTO-Ponta de seta  
MATERIAL-Silex  
QUADRADO-? (Corredor)  
X-  
Y-  
Z-

NOTM165  
OBJECTO-Ponta de seta  
MATERIAL-Silex  
QUADRADO-? (Corredor)  
X-  
Y-  
Z-

NOTM166  
OBJECTO-Ponta de seta  
MATERIAL-Quartzo filoniano  
QUADRADO-? (Corredor)  
X-  
Y-  
Z-

NOTM167  
OBJECTO-Ponta de seta  
MATERIAL-Silex  
QUADRADO-? (Corredor)  
X-  
Y-  
Z-

NOTM168  
OBJECTO-Fragmento de ponta de seta  
MATERIAL-Quartzo hialino  
QUADRADO-? (Corredor)  
X-  
Y-  
Z-

NOTM169  
OBJECTO-Ponta de seta  
MATERIAL-Silex  
QUADRADO-? (Corredor)  
X-  
Y-  
Z-

NOTM170  
OBJECTO-Ponta de seta  
MATERIAL-Silex  
QUADRADO-? (Corredor)  
X-  
Y-  
Z-

NOTM171  
OBJECTO-Ponta de seta  
MATERIAL-Silex  
QUADRADO-? (Corredor)  
X-  
Y-  
Z-

NOTM172  
OBJECTO-Ponta de seta  
MATERIAL-Silex  
QUADRADO-? (Corredor)  
X-  
Y-  
Z-

NOTM173  
OBJECTO-Ponta de seta  
MATERIAL-Silex  
QUADRADO-? (Corredor)  
X-  
Y-  
Z-

NOTM174  
OBJECTO-Ponta de seta  
MATERIAL-Quartzo filoniano  
QUADRADO-? (Corredor)  
X-  
Y-  
Z-

NOTM175  
OBJECTO-Ponta de seta  
MATERIAL-Silex  
QUADRADO-? (Corredor)  
X-  
Y-  
Z-

NOTM176  
OBJECTO-Ponta de seta  
MATERIAL-Silex  
QUADRADO-? (Corredor)  
X-  
Y-  
Z-

NOTM177  
OBJECTO-Fragmento de ponta de seta  
MATERIAL-Quartzo filoniano  
QUADRADO-? (Corredor)  
X-  
Y-  
Z-

NOTM178  
OBJECTO-Ponta de seta  
MATERIAL-Silex  
QUADRADO-? (Corredor)  
X-  
Y-  
Z-

NOTM179  
OBJECTO-Ponta de seta  
MATERIAL-Quartzo hialino  
QUADRADO-? (Corredor)  
X-  
Y-  
Z-

NOTM180  
OBJECTO-Ponta de seta  
MATERIAL-Silex  
QUADRADO-? (Corredor)  
X-  
Y-  
Z-

NOTM181  
OBJECTO-Ponta de seta  
MATERIAL-Silex  
QUADRADO-? (Corredor)  
X-  
Y-  
Z-

NOTM182  
OBJECTO-Ponta de seta  
MATERIAL-Quartzo filoniano  
QUADRADO-? (Corredor)  
X-  
Y-  
Z-

NOTM183  
OBJECTO-Ponta de seta  
MATERIAL-Silex  
QUADRADO-? (Corredor)  
X-  
Y-  
Z-

NOTM184  
OBJECTO-Ponta de seta  
MATERIAL-Silex  
QUADRADO-? (Corredor)  
X-  
Y-  
Z-

NOTM185  
OBJECTO-Ponta de seta  
MATERIAL-Silex  
QUADRADO-? (Corredor)  
X-  
Y-  
Z-

NOTM186  
OBJECTO-Ponta de seta  
MATERIAL-Silex  
QUADRADO-? (Corredor)  
X-  
Y-  
Z-



NGTM187  
OBJECTO-Ponta de seta  
MATERIAL-Silex  
QUADRADO-? (Corredor)  
X-  
Y-  
Z-

NGTM188  
OBJECTO-Ponta de seta  
MATERIAL-Silex  
QUADRADO-? (Corredor)  
X-  
Y-  
Z-

NGTM189  
OBJECTO-Ponta de seta  
MATERIAL-Silex  
QUADRADO-? (Corredor)  
X-  
Y-  
Z-

NGTM190  
OBJECTO-Ponta de seta  
MATERIAL-Quartzo filoniano  
QUADRADO-? (Corredor)  
X-  
Y-  
Z-

NGTM191  
OBJECTO-Ponta de seta  
MATERIAL-Silex  
QUADRADO-? (Corredor)  
X-  
Y-  
Z-

NGTM192  
OBJECTO-Fragmento de ponta de seta  
MATERIAL-Quartzo filoniano  
QUADRADO-? (Corredor)  
X-  
Y-  
Z-

NGTM193  
OBJECTO-Fragmento de ponta de seta  
MATERIAL-Silex  
QUADRADO-? (Corredor)  
X-  
Y-  
Z-

NGTM194  
OBJECTO-Ponta de seta  
MATERIAL-Silex  
QUADRADO-? (Corredor)  
X-  
Y-  
Z-

NGTM195  
OBJECTO-Ponta de seta  
MATERIAL-Silex  
QUADRADO-? (Corredor)  
X-  
Y-  
Z-

NGTM196  
OBJECTO-Ponta de seta  
MATERIAL-Silex  
QUADRADO-? (Corredor)  
X-  
Y-  
Z-

NGTM197  
OBJECTO-Fragmento de ponta de seta  
MATERIAL-Silex  
QUADRADO-? (Corredor)  
X-  
Y-  
Z-

NGTM198  
OBJECTO-Ponta de seta  
MATERIAL-Quartzo hialino  
QUADRADO-? (Corredor)  
X-  
Y-  
Z-

N9TM199  
OBJECTO-Ponta de seta  
MATERIAL-Silex  
QUADRADO-? (Corredor)  
X-  
Y-  
Z-

N9TM200  
OBJECTO-Ponta de seta  
MATERIAL-Silex  
QUADRADO-? (Corredor)  
X-  
Y-  
Z-

N9TM201  
OBJECTO-Ponta de seta  
MATERIAL-Xisto ardosiario  
QUADRADO-? (Corredor)  
X-  
Y-  
Z-

N9TM202  
OBJECTO-Ponta de seta  
MATERIAL-Silex  
QUADRADO-? (Corredor)  
X-  
Y-  
Z-

N9TM203  
OBJECTO-Ponta de seta  
MATERIAL-Xisto ardosiario  
QUADRADO-? (Corredor)  
X-  
Y-  
Z-

N9TM204  
OBJECTO-Ponta de seta  
MATERIAL-Quartzo hialino  
QUADRADO-? (Corredor)  
X-  
Y-  
Z-

N9TM205  
OBJECTO-Fragmento de ponta de seta  
MATERIAL-Silex  
QUADRADO-? (Corredor)  
X-  
Y-  
Z-

N9TM206  
OBJECTO-Fragmento de ponta de seta  
MATERIAL-Silex  
QUADRADO-? (Corredor)  
X-  
Y-  
Z-

N9TM207  
OBJECTO-Ponta de seta  
MATERIAL-Silex  
QUADRADO-? (Corredor)  
X-  
Y-  
Z-

N9TM208  
OBJECTO-Ponta de seta  
MATERIAL-Silex  
QUADRADO-? (Corredor)  
X-  
Y-  
Z-

N9TM209  
OBJECTO-Fragmento de ponta de seta  
MATERIAL-Silex  
QUADRADO-? (Corredor)  
X-  
Y-  
Z-

N9TM210  
OBJECTO-Ponta de seta  
MATERIAL-Silex  
QUADRADO-? (Corredor)  
X-  
Y-  
Z-

NOTM211  
OBJECTO-Ponta de seta  
MATERIAL-Sillex  
QUADRADO-? (Corredor)  
X-  
Y-  
Z-

NOTM212  
OBJECTO-Ponta de seta  
MATERIAL-Sillex  
QUADRADO-? (Corredor)  
X-  
Y-  
Z-

NOTM213  
OBJECTO-Ponta de seta  
MATERIAL-Sillex  
QUADRADO-? (Corredor)  
X-  
Y-  
Z-

NOTM214  
OBJECTO-Ponta de seta  
MATERIAL-Sillex  
QUADRADO-? (Corredor)  
X-  
Y-  
Z-

NOTM215  
OBJECTO-Ponta de seta  
MATERIAL-Sillex  
QUADRADO-? (Corredor)  
X-  
Y-  
Z-

NOTM216  
OBJECTO-Ponta de seta  
MATERIAL-Sillex  
QUADRADO-? (Corredor)  
X-  
Y-  
Z-

NOTM217  
OBJECTO-Ponta de seta  
MATERIAL-Sillex  
QUADRADO-? (Corredor)  
X-  
Y-  
Z-

NOTM218  
OBJECTO-Ponta de seta  
MATERIAL-Sillex  
QUADRADO-? (Corredor)  
X-  
Y-  
Z-

NOTM219  
OBJECTO-Ponta de seta  
MATERIAL-Quartzo hialino  
QUADRADO-? (Corredor)  
X-  
Y-  
Z-

NOTM220  
OBJECTO-Ponta de seta  
MATERIAL-Sillex  
QUADRADO-? (Corredor)  
X-  
Y-  
Z-

NOTM221  
OBJECTO-Ponta de seta  
MATERIAL-Quartzo filoniano  
QUADRADO-? (Corredor)  
X-  
Y-  
Z-

NOTM222  
OBJECTO-Ponta de seta  
MATERIAL-Quartzo filoniano  
QUADRADO-? (Corredor)  
X-  
Y-  
Z-

NotM223  
OBJECTO-Ponta de seta  
MATERIAL-Silex  
QUADRADO-? (Corredor)  
X-  
Y-  
Z-

NotM224  
OBJECTO-Ponta de seta  
MATERIAL-Quartzo filoniano  
QUADRADO-? (Corredor)  
X-  
Y-  
Z-

NotM225  
OBJECTO-Ponta de seta  
MATERIAL-Quartzo filoniano  
QUADRADO-? (Corredor)  
X-  
Y-  
Z-

NotM226  
OBJECTO-Ponta de seta  
MATERIAL-Silex  
QUADRADO-? (Corredor)  
X-  
Y-  
Z-

NotM227  
OBJECTO-Fragmento de Ponta de seta  
MATERIAL-Silex  
QUADRADO-? (Corredor)  
X-  
Y-  
Z-

NotM228  
OBJECTO-Ponta de seta  
MATERIAL-Silex  
QUADRADO-? (Corredor)  
X-  
Y-  
Z-

NotM229  
OBJECTO-Ponta de seta (?)  
MATERIAL-Silex  
QUADRADO-? (Corredor)  
X-  
Y-  
Z-

NotM230  
OBJECTO-Ponta de seta  
MATERIAL-Quartzo filoniano  
QUADRADO-? (Corredor)  
X-  
Y-  
Z-

NotM231  
OBJECTO-Ponta de seta  
MATERIAL-Silex  
QUADRADO-? (Corredor)  
X-  
Y-  
Z-

NotM232  
OBJECTO-Ponta de seta  
MATERIAL-Quartzo hialino  
QUADRADO-? (Corredor)  
X-  
Y-  
Z-

NotM233  
OBJECTO-Ponta de seta  
MATERIAL-Silex  
QUADRADO-? (Corredor)  
X-  
Y-  
Z-

NotM234  
OBJECTO-Ponta de seta  
MATERIAL-Quartzo filoniano  
QUADRADO-? (Corredor)  
X-  
Y-  
Z-

NOTM235  
OBJECTO-Fragmento de ponta de seta  
MATERIAL-Sillex  
QUADRADO-? (Corredor)  
X-  
Y-  
Z-

NOTM236  
OBJECTO-Ponta de seta  
MATERIAL-Sillex  
QUADRADO-? (Corredor)  
X-  
Y-  
Z-

NOTM237  
OBJECTO-Ponta de seta  
MATERIAL-Sillex  
QUADRADO-? (Corredor)  
X-  
Y-  
Z-

NOTM238  
OBJECTO-Ponta de seta  
MATERIAL-Sillex  
QUADRADO-? (Corredor)  
X-  
Y-  
Z-

NOTM239  
OBJECTO-Ponta de seta  
MATERIAL-Sillex  
QUADRADO-? (Corredor)  
X-  
Y-  
Z-

NOTM240  
OBJECTO-Ponta de seta  
MATERIAL-Sillex  
QUADRADO-? (Corredor)  
X-  
Y-  
Z-

NOTM241  
OBJECTO-Ponta de seta  
MATERIAL-Sillex  
QUADRADO-? (Corredor)  
X-  
Y-  
Z-

NOTM242  
OBJECTO-Ponta de seta  
MATERIAL-Sillex  
QUADRADO-? (Corredor)  
X-  
Y-  
Z-

NOTM243  
OBJECTO-Ponta de seta  
MATERIAL-Sillex  
QUADRADO-? (Corredor)  
X-  
Y-  
Z-

NOTM244  
OBJECTO-Ponta de seta  
MATERIAL-Sillex  
QUADRADO-? (Corredor)  
X-  
Y-  
Z-

NOTM245  
OBJECTO-Ponta de seta  
MATERIAL-Quartzo hialino  
QUADRADO-? (Corredor)  
X-  
Y-  
Z-

NOTM246  
OBJECTO-Ponta de seta  
MATERIAL-Quartzo filoniano  
QUADRADO-? (Corredor)  
X-  
Y-  
Z-

NotM247  
OBJECTO-Fragmento de ponta de seta  
MATERIAL-Silex  
QUADRADO-? (Corredor)  
X-  
Y-  
Z-

NotM248  
OBJECTO-Ponta de seta  
MATERIAL-Silex  
QUADRADO-? (Corredor)  
X-  
Y-  
Z-

NotM249  
OBJECTO-Ponta de seta  
MATERIAL-Xisto ardosiario  
QUADRADO-? (Corredor)  
X-  
Y-  
Z-

NotM250  
OBJECTO-Ponta de seta  
MATERIAL-Silex  
QUADRADO-? (Corredor)  
X-  
Y-  
Z-

NotM251  
OBJECTO-Ponta de seta  
MATERIAL-Quartzo filoniano  
QUADRADO-? (Corredor)  
X-  
Y-  
Z-

NotM252  
OBJECTO-Ponta de seta  
MATERIAL-Silex  
QUADRADO-? (Corredor)  
X-  
Y-  
Z-

NotM253  
OBJECTO-Fragmento de ponta de seta  
MATERIAL-Silex  
QUADRADO-? (Corredor)  
X-  
Y-  
Z-

NotM254  
OBJECTO-Ponta de seta  
MATERIAL-Silex  
QUADRADO-? (Corredor)  
X-  
Y-  
Z-

NotM255  
OBJECTO-Ponta de seta  
MATERIAL-Xisto jaspoide  
QUADRADO-? (Corredor)  
X-  
Y-  
Z-

NotM256  
OBJECTO-Ponta de seta  
MATERIAL-Silex  
QUADRADO-? (Corredor)  
X-  
Y-  
Z-

NotM257  
OBJECTO-Ponta de seta  
MATERIAL-Silex  
QUADRADO-? (Corredor)  
X-  
Y-  
Z-

NotM258  
OBJECTO-Fragmento de ponta de seta  
MATERIAL-Silex  
QUADRADO-? (Corredor)  
X-  
Y-  
Z-

NOTM259  
OBJECTO-Ponta de seta  
MATERIAL-Sillex  
QUADRADO-? (Corredor)  
X-  
Y-  
Z-

NOTM260  
OBJECTO-Fragmento de ponta de seta  
MATERIAL-Sillex  
QUADRADO-? (Corredor)  
X-  
Y-  
Z-

NOTM261  
OBJECTO-Ponta de seta  
MATERIAL-Sillex  
QUADRADO-? (Corredor)  
X-  
Y-  
Z-

NOTM262  
OBJECTO-Ponta de seta  
MATERIAL-Sillex  
QUADRADO-? (Corredor)  
X-  
Y-  
Z-

NOTM263  
OBJECTO-Ponta de seta  
MATERIAL-Sillex  
QUADRADO-? (Corredor)  
X-  
Y-  
Z-

NOTM266  
OBJECTO-Ponta de seta  
MATERIAL-Sillex  
QUADRADO-? (Corredor)  
X-  
Y-  
Z-

NOTM267  
OBJECTO-Ponta de seta  
MATERIAL-Quartzo hialino  
QUADRADO-? (Corredor)  
X-  
Y-  
Z-

NOTM268  
OBJECTO-Ponta de seta  
MATERIAL-Sillex  
QUADRADO-? (Corredor)  
X-  
Y-  
Z-

NOTM269  
OBJECTO-Machado  
MATERIAL-Anfibolite  
QUADRADO-? (Corredor)  
X-  
Y-  
Z-

NOTM270  
OBJECTO-Machado  
MATERIAL-Anfibolite  
QUADRADO-? (Corredor)  
X-  
Y-  
Z-

NOTM271  
OBJECTO-Machado  
MATERIAL-Anfibolite  
QUADRADO-? (Corredor)  
X-  
Y-  
Z-

NOTM272  
OBJECTO-Machado  
MATERIAL-Anfibolite  
QUADRADO-? (Corredor)  
X-  
Y-  
Z-

NotM273  
OBJECTO-Fragmento de idolo-placa  
MATERIAL-Grés  
QUADRADO-? (Corredor)  
X-  
Y-  
Z-

NotM274  
OBJECTO-Fragmento de idolo-placa  
MATERIAL-Xisto  
QUADRADO-? (Corredor)  
X-  
Y-  
Z-

NotM275  
OBJECTO-Idolo-placa  
MATERIAL-Xisto  
QUADRADO-? (Corredor)  
X-  
Y-  
Z-

NotM276  
OBJECTO-Fragmento de idolo-placa  
MATERIAL-Xisto  
QUADRADO-? (Corredor)  
X-  
Y-  
Z-

NotM277  
OBJECTO-Fragmento de idolo-placa  
MATERIAL-Xisto  
QUADRADO-? (Corredor)  
X-  
Y-  
Z-

NotM278  
OBJECTO-Fragmento de idolo-placa  
MATERIAL-Xisto  
QUADRADO-? (Corredor)  
X-  
Y-  
Z-

NotM279  
OBJECTO-Fragmento de idolo-placa  
MATERIAL-Xisto  
QUADRADO-? (Corredor)  
X-  
Y-  
Z-

NotM280  
OBJECTO-Fragmento de idolo-placa  
MATERIAL-Xisto  
QUADRADO-? (Corredor)  
X-  
Y-  
Z-

NotM281  
OBJECTO-Idolo-placa  
MATERIAL-Grés  
QUADRADO-? (Corredor)  
X-  
Y-  
Z-

NotM282  
OBJECTO-Fragmento de idolo-placa  
MATERIAL-Grés  
QUADRADO-? (Corredor)  
X-  
Y-  
Z-

NotM292  
OBJECTO-Pendente  
MATERIAL-Rocha verde  
QUADRADO-? (Corredor)  
X-  
Y-  
Z-

NotM293  
OBJECTO-Pendente  
MATERIAL-Xisto  
QUADRADO-? (Corredor)  
X-  
Y-  
Z-



NGTM294  
OBJECTO-Pendiente  
MATERIAL-Rocha verde  
QUADRADO-? (Corredor)  
X-  
Y-  
Z-

NGTM295  
OBJECTO-Pendiente  
MATERIAL-Calaite (?)  
QUADRADO-? (Corredor)  
X-  
Y-  
Z-

NGTM296  
OBJECTO-Pendiente  
MATERIAL-Calaite (?)  
QUADRADO-? (Corredor)  
X-  
Y-  
Z-

NGTM297  
OBJECTO-Pendiente  
MATERIAL-Rocha verde  
QUADRADO-? (Corredor)  
X-  
Y-  
Z-

NGTM298  
OBJECTO-Pendiente  
MATERIAL-Calaite  
QUADRADO-? (Corredor)  
X-  
Y-  
Z-

NGTM299  
OBJECTO-Conta de colar  
MATERIAL-Rocha verde  
QUADRADO-? (Corredor)  
X-  
Y-  
Z-

NGTM300  
OBJECTO-Conta de colar  
MATERIAL-Ambar  
QUADRADO-? (Corredor)  
X-  
Y-  
Z-

NGTM301  
OBJECTO-Conta de colar  
MATERIAL-Rocha verde  
QUADRADO-? (Corredor)  
X-  
Y-  
Z-

NGTM302  
OBJECTO-Conta de colar  
MATERIAL-Rocha verde  
QUADRADO-? (Corredor)  
X-  
Y-  
Z-

NGTM303  
OBJECTO-Conta de colar  
MATERIAL-Ambar  
QUADRADO-? (Corredor)  
X-  
Y-  
Z-

NGTM304  
OBJECTO-Conta de colar  
MATERIAL-Rocha verde  
QUADRADO-? (Corredor)  
X-  
Y-  
Z-

NGTM305  
OBJECTO-Conta de colar  
MATERIAL-Calaite (?)  
QUADRADO-? (Corredor)  
X-  
Y-  
Z-

NqTM306  
OBJECTO-Conta de colar  
MATERIAL-Xisto  
QUADRADO-? (Corredor)  
X-  
Y-  
Z-

NqTM307  
OBJECTO-Conta de colar  
MATERIAL-Rocha verde  
QUADRADO-? (Corredor)  
X-  
Y-  
Z-

NqTM308  
OBJECTO-Conta de colar  
MATERIAL-ãambar  
QUADRADO-? (Corredor)  
X-  
Y-  
Z-

NqTM309  
OBJECTO-Conta de colar  
MATERIAL-Xisto  
QUADRADO-? (Corredor)  
X-  
Y-  
Z-

NqTM310  
OBJECTO-Conta de colar  
MATERIAL-Rocha verde  
QUADRADO-? (Corredor)  
X-  
Y-  
Z-

NqTM311  
OBJECTO-Conta de colar  
MATERIAL-Xisto  
QUADRADO-? (Corredor)  
X-  
Y-  
Z-

NqTM312  
OBJECTO-Conta de colar  
MATERIAL-Xisto  
QUADRADO-? (Corredor)  
X-  
Y-  
Z-

NqTM313  
OBJECTO-Conta de colar  
MATERIAL-Xisto  
QUADRADO-? (Corredor)  
X-  
Y-  
Z-

NqTM314  
OBJECTO-Conta de colar  
MATERIAL-Xisto  
QUADRADO-? (Corredor)  
X-  
Y-  
Z-

NqTM315  
OBJECTO-Conta de colar  
MATERIAL-Xisto  
QUADRADO-? (Corredor)  
X-  
Y-  
Z-

NqTM316  
OBJECTO-Conta de colar  
MATERIAL-Xisto  
QUADRADO-? (Corredor)  
X-  
Y-  
Z-

NqTM317  
OBJECTO-Conta de colar  
MATERIAL-Xisto  
QUADRADO-? (Corredor)  
X-  
Y-  
Z-

NETM318  
OBJECTO-Conta de colar  
MATERIAL-Xisto  
QUADRADO-? (Corredor)  
X-  
Y-  
Z-

NETM319  
OBJECTO-Conta de colar  
MATERIAL-Xisto  
QUADRADO-? (Corredor)  
X-  
Y-  
Z-

NETM320  
OBJECTO-Conta de colar  
MATERIAL-Xisto  
QUADRADO-? (Corredor)  
X-  
Y-  
Z-

NETM321  
OBJECTO-Conta de colar  
MATERIAL-Xisto  
QUADRADO-? (Corredor)  
X-  
Y-  
Z-

NETM322  
OBJECTO-Conta de colar  
MATERIAL-Xisto  
QUADRADO-? (Corredor)  
X-  
Y-  
Z-

NETM323  
OBJECTO-Conta de colar  
MATERIAL-Xisto  
QUADRADO-? (Corredor)  
X-  
Y-  
Z-

NETM324  
OBJECTO-Conta de colar  
MATERIAL-Xisto  
QUADRADO-? (Corredor)  
X-  
Y-  
Z-

NETM325  
OBJECTO-Conta de colar  
MATERIAL-Xisto  
QUADRADO-? (Corredor)  
X-  
Y-  
Z-

NETM326  
OBJECTO-Conta de colar  
MATERIAL-Xisto  
QUADRADO-? (Corredor)  
X-  
Y-  
Z-

NETM327  
OBJECTO-Conta de colar  
MATERIAL-Xisto  
QUADRADO-? (Corredor)  
X-  
Y-  
Z-

NETM328  
OBJECTO-Conta de colar  
MATERIAL-Xisto  
QUADRADO-? (Corredor)  
X-  
Y-  
Z-

NETM329  
OBJECTO-Conta de colar  
MATERIAL-Xisto  
QUADRADO-? (Corredor)  
X-  
Y-  
Z-

NOTM330  
OBJECTO-Conta de colar  
MATERIAL-Xisto  
QUADRADO-? (Corredor)  
X-  
Y-  
Z-

NOTM331  
OBJECTO-Conta de colar  
MATERIAL-Xisto  
QUADRADO-? (Corredor)  
X-  
Y-  
Z-

NOTM332  
OBJECTO-Conta de colar  
MATERIAL-Xisto  
QUADRADO-? (Corredor)  
X-  
Y-  
Z-

NOTM333  
OBJECTO-Conta de colar  
MATERIAL-Xisto  
QUADRADO-? (Corredor)  
X-  
Y-  
Z-

NOTM334  
OBJECTO-Conta de colar  
MATERIAL-Xisto  
QUADRADO-? (Corredor)  
X-  
Y-  
Z-

NOTM335  
OBJECTO-Conta de colar  
MATERIAL-Xisto  
QUADRADO-? (Corredor)  
X-  
Y-  
Z-

NOTM336  
OBJECTO-Conta de colar  
MATERIAL-Xisto  
QUADRADO-? (Corredor)  
X-  
Y-  
Z-

NOTM337  
OBJECTO-Conta de colar  
MATERIAL-Xisto  
QUADRADO-? (Corredor)  
X-  
Y-  
Z-

NOTM338  
OBJECTO-Conta de colar  
MATERIAL-Xisto  
QUADRADO-? (Corredor)  
X-  
Y-  
Z-

NOTM339  
OBJECTO-Conta de colar  
MATERIAL-Xisto  
QUADRADO-? (Corredor)  
X-  
Y-  
Z-

NOTM340  
OBJECTO-Conta de colar  
MATERIAL-Xisto  
QUADRADO-? (Corredor)  
X-  
Y-  
Z-

NOTM341  
OBJECTO-Conta de colar  
MATERIAL-Xisto  
QUADRADO-? (Corredor)  
X-  
Y-  
Z-

NETM342  
OBJECTO-Conta de colar  
MATERIAL-Xisto  
QUADRADO-? (Corredor)  
X-  
Y-  
Z-

NETM343  
OBJECTO-Conta de colar  
MATERIAL-Xisto  
QUADRADO-? (Corredor)  
X-  
Y-  
Z-

NETM344  
OBJECTO-Conta de colar  
MATERIAL-Xisto  
QUADRADO-? (Corredor)  
X-  
Y-  
Z-

NETM345  
OBJECTO-Conta de colar  
MATERIAL-Xisto  
QUADRADO-? (Corredor)  
X-  
Y-  
Z-

NETM346  
OBJECTO-Conta de colar  
MATERIAL-Xisto  
QUADRADO-? (Corredor)  
X-  
Y-  
Z-

NETM347  
OBJECTO-Conta de colar  
MATERIAL-Xisto  
QUADRADO-? (Corredor)  
X-  
Y-  
Z-

NETM348  
OBJECTO-Conta de colar  
MATERIAL-Xisto  
QUADRADO-? (Corredor)  
X-  
Y-  
Z-

NETM349  
OBJECTO-Conta de colar  
MATERIAL-Xisto  
QUADRADO-? (Corredor)  
X-  
Y-  
Z-

NETM350  
OBJECTO-Conta de colar  
MATERIAL-Xisto  
QUADRADO-? (Corredor)  
X-  
Y-  
Z-

NETM351  
OBJECTO-Conta de colar  
MATERIAL-Xisto  
QUADRADO-? (Corredor)  
X-  
Y-  
Z-

NETM352  
OBJECTO-Conta de colar  
MATERIAL-Xisto  
QUADRADO-? (Corredor)  
X-  
Y-  
Z-

NETM353  
OBJECTO-Conta de colar  
MATERIAL-Xisto  
QUADRADO-? (Corredor)  
X-  
Y-  
Z-

NOTM354  
OBJECTO-Conta de colar  
MATERIAL-Xisto  
QUADRADO-? (Corredor)  
X-  
Y-  
Z-

NOTM355  
OBJECTO-Conta de colar  
MATERIAL-Xisto  
QUADRADO-? (Corredor)  
X-  
Y-  
Z-

NOTM356  
OBJECTO-Conta de colar  
MATERIAL-Xisto  
QUADRADO-? (Corredor)  
X-  
Y-  
Z-

NOTM357  
OBJECTO-Conta de colar  
MATERIAL-Xisto  
QUADRADO-? (Corredor)  
X-  
Y-  
Z-

NOTM358  
OBJECTO-Conta de colar  
MATERIAL-Xisto  
QUADRADO-? (Corredor)  
X-  
Y-  
Z-

NOTM359  
OBJECTO-Conta de colar  
MATERIAL-Xisto  
QUADRADO-? (Corredor)  
X-  
Y-  
Z-

NOTM360  
OBJECTO-Conta de colar  
MATERIAL-Xisto  
QUADRADO-? (Corredor)  
X-  
Y-  
Z-

NOTM361  
OBJECTO-Conta de colar  
MATERIAL-Xisto  
QUADRADO-? (Corredor)  
X-  
Y-  
Z-

NOTM362  
OBJECTO-Conta de colar  
MATERIAL-Xisto  
QUADRADO-? (Corredor)  
X-  
Y-  
Z-

NOTM363  
OBJECTO-Conta de colar  
MATERIAL-Xisto  
QUADRADO-? (Corredor)  
X-  
Y-  
Z-

NOTM364  
OBJECTO-Conta de colar  
MATERIAL-Xisto  
QUADRADO-? (Corredor)  
X-  
Y-  
Z-

NOTM365  
OBJECTO-Conta de colar  
MATERIAL-Xisto  
QUADRADO-? (Corredor)  
X-  
Y-  
Z-

NETM366  
OBJECTO-Conta de colar  
MATERIAL-Xisto  
QUADRADO-? (Corredor)  
X-  
Y-  
Z-

NETM367  
OBJECTO-Conta de colar  
MATERIAL-Xisto  
QUADRADO-? (Corredor)  
X-  
Y-  
Z-

NETM368  
OBJECTO-Conta de colar  
MATERIAL-Xisto  
QUADRADO-? (Corredor)  
X-  
Y-  
Z-

NETM369  
OBJECTO-Conta de colar  
MATERIAL-Xisto  
QUADRADO-? (Corredor)  
X-  
Y-  
Z-

NETM370  
OBJECTO-Conta de colar  
MATERIAL-Xisto  
QUADRADO-? (Corredor)  
X-  
Y-  
Z-

NETM371  
OBJECTO-Conta de colar  
MATERIAL-Xisto  
QUADRADO-? (Corredor)  
X-  
Y-  
Z-

NETM372  
OBJECTO-Conta de colar  
MATERIAL-Xisto  
QUADRADO-? (Corredor)  
X-  
Y-  
Z-

NETM373  
OBJECTO-Conta de colar  
MATERIAL-Xisto  
QUADRADO-? (Corredor)  
X-  
Y-  
Z-

NETM374  
OBJECTO-Conta de colar  
MATERIAL-Xisto  
QUADRADO-? (Corredor)  
X-  
Y-  
Z-

NETM375  
OBJECTO-Conta de colar  
MATERIAL-Xisto  
QUADRADO-? (Corredor)  
X-  
Y-  
Z-

NETM376  
OBJECTO-Conta de colar  
MATERIAL-Xisto  
QUADRADO-? (Corredor)  
X-  
Y-  
Z-

NETM377  
OBJECTO-Conta de colar  
MATERIAL-Xisto  
QUADRADO-? (Corredor)  
X-  
Y-  
Z-

NotM384  
OBJECTO-Conta de colar  
MATERIAL-Xisto  
QUADRADO-? (Corredor)  
X-  
Y-  
Z-

NotM385  
OBJECTO-Conta de colar  
MATERIAL-Xisto  
QUADRADO-? (Corredor)  
X-  
Y-  
Z-

NotM386  
OBJECTO-Conta de colar  
MATERIAL-Xisto  
QUADRADO-? (Corredor)  
X-  
Y-  
Z-

NotM387  
OBJECTO-Conta de colar  
MATERIAL-Xisto  
QUADRADO-? (Corredor)  
X-  
Y-  
Z-

NotM388  
OBJECTO-Conta de colar  
MATERIAL-Xisto  
QUADRADO-? (Corredor)  
X-  
Y-  
Z-

NotM389  
OBJECTO-Conta de colar  
MATERIAL-Xisto  
QUADRADO-? (Corredor)  
X-  
Y-  
Z-

NotM378  
OBJECTO-Conta de colar  
MATERIAL-Xisto  
QUADRADO-? (Corredor)  
X-  
Y-  
Z-

NotM379  
OBJECTO-Conta de colar  
MATERIAL-Xisto  
QUADRADO-? (Corredor)  
X-  
Y-  
Z-

NotM380  
OBJECTO-Conta de colar  
MATERIAL-Xisto  
QUADRADO-? (Corredor)  
X-  
Y-  
Z-

NotM381  
OBJECTO-Conta de colar  
MATERIAL-Xisto  
QUADRADO-? (Corredor)  
X-  
Y-  
Z-

NotM382  
OBJECTO-Conta de colar  
MATERIAL-Xisto  
QUADRADO-? (Corredor)  
X-  
Y-  
Z-

NotM383  
OBJECTO-Conta de colar  
MATERIAL-Xisto  
QUADRADO-? (Corredor)  
X-  
Y-  
Z-



NOTM390  
OBJECTO-Conta de colar  
MATERIAL-Xisto  
QUADRADO-? (Corredor)  
X-  
Y-  
Z-

NOTM391  
OBJECTO-Conta de colar  
MATERIAL-Xisto  
QUADRADO-? (Corredor)  
X-  
Y-  
Z-

NOTM392  
OBJECTO-Conta de colar  
MATERIAL-Xisto  
QUADRADO-? (Corredor)  
X-  
Y-  
Z-

NOTM393  
OBJECTO-Conta de colar  
MATERIAL-Xisto  
QUADRADO-? (Corredor)  
X-  
Y-  
Z-

NOTM394  
OBJECTO-Conta de colar  
MATERIAL-Xisto  
QUADRADO-? (Corredor)  
X-  
Y-  
Z-

NOTM395  
OBJECTO-Conta de colar  
MATERIAL-Xisto  
QUADRADO-? (Corredor)  
X-  
Y-  
Z-

NOTM396  
OBJECTO-Conta de colar  
MATERIAL-Xisto  
QUADRADO-? (Corredor)  
X-  
Y-  
Z-

NOTM397  
OBJECTO-Conta de colar  
MATERIAL-Xisto  
QUADRADO-? (Corredor)  
X-  
Y-  
Z-

NOTM398  
OBJECTO-Conta de colar  
MATERIAL-Xisto  
QUADRADO-? (Corredor)  
X-  
Y-  
Z-

NOTM399  
OBJECTO-Conta de colar  
MATERIAL-Xisto  
QUADRADO-? (Corredor)  
X-  
Y-  
Z-

NOTM400  
OBJECTO-Conta de colar  
MATERIAL-Xisto  
QUADRADO-? (Corredor)  
X-  
Y-  
Z-

NOTM401  
OBJECTO-Conta de colar  
MATERIAL-Xisto  
QUADRADO-? (Corredor)  
X-  
Y-  
Z-

NOTM402  
OBJECTO-Conta de colar  
MATERIAL-Xisto  
QUADRADO-? (Corredor)  
X-  
Y-  
Z-

NOTM403  
OBJECTO-Conta de colar  
MATERIAL-Xisto  
QUADRADO-? (Corredor)  
X-  
Y-  
Z-

NOTM404  
OBJECTO-Conta de colar  
MATERIAL-Xisto  
QUADRADO-? (Corredor)  
X-  
Y-  
Z-

NOTM405  
OBJECTO-Conta de colar  
MATERIAL-Xisto  
QUADRADO-? (Corredor)  
X-  
Y-  
Z-

NOTM406  
OBJECTO-Conta de colar  
MATERIAL-Xisto  
QUADRADO-? (Corredor)  
X-  
Y-  
Z-

NOTM407  
OBJECTO-Conta de colar  
MATERIAL-Xisto  
QUADRADO-? (Corredor)  
X-  
Y-  
Z-

NOTM408  
OBJECTO-Conta de colar  
MATERIAL-Xisto  
QUADRADO-? (Corredor)  
X-  
Y-  
Z-

NOTM409  
OBJECTO-Conta de colar  
MATERIAL-Xisto  
QUADRADO-? (Corredor)  
X-  
Y-  
Z-

NOTM410  
OBJECTO-Conta de colar  
MATERIAL-Xisto  
QUADRADO-? (Corredor)  
X-  
Y-  
Z-

NOTM411  
OBJECTO-Conta de colar  
MATERIAL-Xisto  
QUADRADO-? (Corredor)  
X-  
Y-  
Z-

NOTM412  
OBJECTO-Conta de colar  
MATERIAL-Xisto  
QUADRADO-? (Corredor)  
X-  
Y-  
Z-

NOTM413  
OBJECTO-Conta de colar  
MATERIAL-Xisto  
QUADRADO-? (Corredor)  
X-  
Y-  
Z-

NOTM414  
OBJECTO-Conta de colar  
MATERIAL-Xisto  
QUADRADO-? (Corredor)  
X-  
Y-  
Z-

NOTM415  
OBJECTO-Conta de colar  
MATERIAL-Xisto  
QUADRADO-? (Corredor)  
X-  
Y-  
Z-

NOTM416  
OBJECTO-Conta de colar  
MATERIAL-Xisto  
QUADRADO-? (Corredor)  
X-  
Y-  
Z-

NOTM417  
OBJECTO-Conta de colar  
MATERIAL-Xisto  
QUADRADO-? (Corredor)  
X-  
Y-  
Z-

NOTM418  
OBJECTO-Conta de colar  
MATERIAL-Xisto  
QUADRADO-? (Corredor)  
X-  
Y-  
Z-

NOTM419  
OBJECTO-Conta de colar  
MATERIAL-Xisto  
QUADRADO-? (Corredor)  
X-  
Y-  
Z-

NOTM420  
OBJECTO-Conta de colar  
MATERIAL-Xisto  
QUADRADO-? (Corredor)  
X-  
Y-  
Z-

NOTM421  
OBJECTO-Conta de colar  
MATERIAL-Xisto  
QUADRADO-? (Corredor)  
X-  
Y-  
Z-

NOTM422  
OBJECTO-Conta de colar  
MATERIAL-Xisto  
QUADRADO-? (Corredor)  
X-  
Y-  
Z-

NOTM423  
OBJECTO-Conta de colar  
MATERIAL-Xisto  
QUADRADO-? (Corredor)  
X-  
Y-  
Z-

NOTM424  
OBJECTO-Conta de colar  
MATERIAL-Xisto  
QUADRADO-? (Corredor)  
X-  
Y-  
Z-

NOTM425  
OBJECTO-Conta de colar  
MATERIAL-Xisto  
QUADRADO-? (Corredor)  
X-  
Y-  
Z-

NOTM426  
OBJECTO-Conta de colar  
MATERIAL-Xisto  
QUADRADO-? (Corredor)  
X-  
Y-  
Z-

NOTM427  
OBJECTO-Conta de colar  
MATERIAL-Xisto  
QUADRADO-? (Corredor)  
X-  
Y-  
Z-

NOTM428  
OBJECTO-Conta de colar  
MATERIAL-Xisto  
QUADRADO-? (Corredor)  
X-  
Y-  
Z-

NOTM429  
OBJECTO-Conta de colar  
MATERIAL-Xisto  
QUADRADO-? (Corredor)  
X-  
Y-  
Z-

NOTM430  
OBJECTO-Conta de colar  
MATERIAL-Xisto  
QUADRADO-? (Corredor)  
X-  
Y-  
Z-

NOTM431  
OBJECTO-Conta de colar  
MATERIAL-Xisto  
QUADRADO-? (Corredor)  
X-  
Y-  
Z-

NOTM432  
OBJECTO-Conta de colar  
MATERIAL-Xisto  
QUADRADO-? (Corredor)  
X-  
Y-  
Z-

NOTM433  
OBJECTO-Conta de colar  
MATERIAL-Xisto  
QUADRADO-? (Corredor)  
X-  
Y-  
Z-

NOTM434  
OBJECTO-Conta de colar  
MATERIAL-Xisto  
QUADRADO-? (Corredor)  
X-  
Y-  
Z-

NOTM435  
OBJECTO-Conta de colar  
MATERIAL-Xisto  
QUADRADO-? (Corredor)  
X-  
Y-  
Z-

NOTM436  
OBJECTO-Conta de colar  
MATERIAL-Xisto  
QUADRADO-? (Corredor)  
X-  
Y-  
Z-

NOTM437  
OBJECTO-Conta de colar  
MATERIAL-Xisto  
QUADRADO-? (Corredor)  
X-  
Y-  
Z-

NOTM438  
OBJECTO-Conta de colar  
MATERIAL-Xisto  
QUADRADO-? (Corredor)  
X-  
Y-  
Z-

NOTM439  
OBJECTO-Conta de colar  
MATERIAL-Xisto  
QUADRADO-? (Corredor)  
X-  
Y-  
Z-

NOTM440  
OBJECTO-Conta de colar  
MATERIAL-Xisto  
QUADRADO-? (Corredor)  
X-  
Y-  
Z-

NOTM441  
OBJECTO-Conta de colar  
MATERIAL-Xisto  
QUADRADO-? (Corredor)  
X-  
Y-  
Z-

NOTM442  
OBJECTO-Conta de colar  
MATERIAL-Xisto  
QUADRADO-? (Corredor)  
X-  
Y-  
Z-

NOTM443  
OBJECTO-Conta de colar  
MATERIAL-Xisto  
QUADRADO-? (Corredor)  
X-  
Y-  
Z-

NOTM444  
OBJECTO-Conta de colar  
MATERIAL-Xisto  
QUADRADO-? (Corredor)  
X-  
Y-  
Z-

NOTM445  
OBJECTO-Conta de colar  
MATERIAL-Xisto  
QUADRADO-? (Corredor)  
X-  
Y-  
Z-

NOTM446  
OBJECTO-Conta de colar  
MATERIAL-Xisto  
QUADRADO-? (Corredor)  
X-  
Y-  
Z-

NOTM447  
OBJECTO-Conta de colar  
MATERIAL-Xisto  
QUADRADO-? (Corredor)  
X-  
Y-  
Z-

NOTM448  
OBJECTO-Conta de colar  
MATERIAL-Xisto  
QUADRADO-? (Corredor)  
X-  
Y-  
Z-

NOTM449  
OBJECTO-Conta de colar  
MATERIAL-Xisto  
QUADRADO-? (Corredor)  
X-  
Y-  
Z-

NOTM450  
OBJECTO-Conta de colar  
MATERIAL-Xisto  
QUADRADO-? (Corredor)  
X-  
Y-  
Z-

NOTM451  
OBJECTO-Conta de colar  
MATERIAL-Xisto  
QUADRADO-? (Corredor)  
X-  
Y-  
Z-

NOTM452  
OBJECTO-Conta de colar  
MATERIAL-Xisto  
QUADRADO-? (Corredor)  
X-  
Y-  
Z-

NOTM453  
OBJECTO-Conta de colar  
MATERIAL-Xisto  
QUADRADO-? (Corredor)  
X-  
Y-  
Z-

NOTM454  
OBJECTO-Conta de colar  
MATERIAL-Xisto  
QUADRADO-? (Corredor)  
X-  
Y-  
Z-

NOTM455  
OBJECTO-Conta de colar  
MATERIAL-Xisto  
QUADRADO-? (Corredor)  
X-  
Y-  
Z-

NOTM456  
OBJECTO-Conta de colar  
MATERIAL-Xisto  
QUADRADO-? (Corredor)  
X-  
Y-  
Z-

NOTM457  
OBJECTO-Conta de colar  
MATERIAL-Xisto  
QUADRADO-? (Corredor)  
X-  
Y-  
Z-

NOTM458  
OBJECTO-Conta de colar  
MATERIAL-Xisto  
QUADRADO-? (Corredor)  
X-  
Y-  
Z-

NOTM459  
OBJECTO-Conta de colar  
MATERIAL-Xisto  
QUADRADO-? (Corredor)  
X-  
Y-  
Z-

NOTM460  
OBJECTO-Conta de colar  
MATERIAL-Xisto  
QUADRADO-? (Corredor)  
X-  
Y-  
Z-

NGTM461  
OBJECTO-Conta de colar  
MATERIAL-Xisto  
QUADRADO-? (Corredor)  
X-  
Y-  
Z-

NGTM462  
OBJECTO-Conta de colar  
MATERIAL-Xisto  
QUADRADO-? (Corredor)  
X-  
Y-  
Z-

NGTM463  
OBJECTO-Conta de colar  
MATERIAL-Xisto  
QUADRADO-? (Corredor)  
X-  
Y-  
Z-

NGTM464  
OBJECTO-Conta de colar  
MATERIAL-Rocha verde  
QUADRADO-? (Corredor)  
X-  
Y-  
Z-

NGTM465  
OBJECTO-Conta de colar  
MATERIAL-Xisto  
QUADRADO-? (Corredor)  
X-  
Y-  
Z-

NGTM466  
OBJECTO-Conta de colar  
MATERIAL-Xisto  
QUADRADO-? (Corredor)  
X-  
Y-  
Z-

NGTM46731  
OBJECTO-Conta de colar  
MATERIAL-Xisto  
QUADRADO-? (Corredor)  
X-  
Y-  
Z-

NGTM468  
OBJECTO-Conta de colar  
MATERIAL-Xisto  
QUADRADO-? (Corredor)  
X-  
Y-  
Z-

NGTM469  
OBJECTO-Conta de colar  
MATERIAL-Ámbar  
QUADRADO-? (Corredor)  
X-  
Y-  
Z-

NGTM470  
OBJECTO-Conta de colar  
MATERIAL-Xisto  
QUADRADO-? (Corredor)  
X-  
Y-  
Z-

NGTM471  
OBJECTO-Conta de colar  
MATERIAL-Xisto  
QUADRADO-? (Corredor)  
X-  
Y-  
Z-

NGTM472  
OBJECTO-Conta de colar  
MATERIAL-Xisto  
QUADRADO-? (Corredor)  
X-  
Y-  
Z-

NOTM473  
OBJECTO-Conta de colar  
MATERIAL-Xisto  
QUADRADO-? (Corredor)  
X-  
Y-  
Z-

NOTM474  
OBJECTO-Conta de colar  
MATERIAL-Rocha verde  
QUADRADO-? (Corredor)  
X-  
Y-  
Z-

NOTM475  
OBJECTO-Conta de colar  
MATERIAL-Xisto  
QUADRADO-? (Corredor)  
X-  
Y-  
Z-

NOTM476  
OBJECTO-Conta de colar  
MATERIAL-Xisto  
QUADRADO-? (Corredor)  
X-  
Y-  
Z-

NOTM477  
OBJECTO-Conta de colar  
MATERIAL-Xisto  
QUADRADO-? (Corredor)  
X-  
Y-  
Z-

NOTM478  
OBJECTO-Conta de colar  
MATERIAL-Xisto  
QUADRADO-? (Corredor)  
X-  
Y-  
Z-

NOTM479  
OBJECTO-Conta de colar  
MATERIAL-Xisto  
QUADRADO-? (Corredor)  
X-  
Y-  
Z-

NOTM480  
OBJECTO-Conta de colar  
MATERIAL-Xisto  
QUADRADO-? (Corredor)  
X-  
Y-  
Z-

NOTM481  
OBJECTO-Conta de colar  
MATERIAL-Xisto  
QUADRADO-? (Corredor)  
X-  
Y-  
Z-

NOTM482  
OBJECTO-Conta de colar  
MATERIAL-Xisto  
QUADRADO-? (Corredor)  
X-  
Y-  
Z-

NOTM483  
OBJECTO-Conta de colar  
MATERIAL-Xisto  
QUADRADO-? (Corredor)  
X-  
Y-  
Z-

NOTM484  
OBJECTO-Conta de colar  
MATERIAL-Xisto  
QUADRADO-? (Corredor)  
X-  
Y-  
Z-



NETM485  
OBJECTO-Conta de colar  
MATERIAL-Xisto  
QUADRADO-? (Corredor)  
X-  
Y-  
Z-

NETM486  
OBJECTO-Conta de colar  
MATERIAL-Xisto  
QUADRADO-? (Corredor)  
X-  
Y-  
Z-

NETM487  
OBJECTO-Conta de colar  
MATERIAL-Xisto  
QUADRADO-? (Corredor)  
X-  
Y-  
Z-

NETM488  
OBJECTO-Conta de colar  
MATERIAL-Xisto  
QUADRADO-? (Corredor)  
X-  
Y-  
Z-

NETM489  
OBJECTO-Conta de colar  
MATERIAL-Xisto  
QUADRADO-? (Corredor)  
X-  
Y-  
Z-

NETM490  
OBJECTO-Conta de colar  
MATERIAL-Xisto  
QUADRADO-? (Corredor)  
X-  
Y-  
Z-

NETM491  
OBJECTO-Conta de colar  
MATERIAL-Xisto  
QUADRADO-? (Corredor)  
X-  
Y-  
Z-

NETM492  
OBJECTO-Conta de colar  
MATERIAL-Xisto  
QUADRADO-? (Corredor)  
X-  
Y-  
Z-

NETM493  
OBJECTO-Conta de colar  
MATERIAL-Xisto  
QUADRADO-? (Corredor)  
X-  
Y-  
Z-

NETM494  
OBJECTO-Conta de colar  
MATERIAL-Xisto  
QUADRADO-? (Corredor)  
X-  
Y-  
Z-

NETM495  
OBJECTO-Conta de colar  
MATERIAL-Xisto  
QUADRADO-? (Corredor)  
X-  
Y-  
Z-

NETM496  
OBJECTO-Conta de colar  
MATERIAL-Xisto  
QUADRADO-? (Corredor)  
X-  
Y-  
Z-

NqTM497  
OBJECTO-Conta de colar  
MATERIAL-Xisto  
QUADRADO-? (Corredor)  
X-  
Y-  
Z-

NqTM498  
OBJECTO-Conta de colar  
MATERIAL-Xisto  
QUADRADO-? (Corredor)  
X-  
Y-  
Z-

NqTM499  
OBJECTO-Conta de colar  
MATERIAL-Xisto  
QUADRADO-? (Corredor)  
X-  
Y-  
Z-

NqTM500  
OBJECTO-Buril duplo  
MATERIAL-Silex  
QUADRADO-? (Corredor)  
X-  
Y-  
Z-

NqTM501  
OBJECTO-Geométrico  
MATERIAL-Silex  
QUADRADO-? (Corredor)  
X-  
Y-  
Z-

NqTM502  
OBJECTO-Geométrico  
MATERIAL-Silex  
QUADRADO-? (Corredor)  
X-  
Y-  
Z-

NqTM503  
OBJECTO-Geométrico  
MATERIAL-Silex  
QUADRADO-? (Corredor)  
X-  
Y-  
Z-

NqTM505  
OBJECTO-Geométrico  
MATERIAL-Silex  
QUADRADO-? (Corredor)  
X-  
Y-  
Z-

NqTM506  
OBJECTO-Geométrico  
MATERIAL-Silex  
QUADRADO-? (Corredor)  
X-  
Y-  
Z-

NqTM507  
OBJECTO-Fragmento de alabarda (?)  
MATERIAL-Silex  
QUADRADO-? (Corredor)  
X-  
Y-  
Z-

NqTM508  
OBJECTO-Fragmento de alabarda  
MATERIAL-Silex  
QUADRADO-? (Corredor)  
X-  
Y-  
Z-

NqTM509  
OBJECTO-Fragmento de alabarda  
MATERIAL-Silex  
QUADRADO-? (Corredor)  
X-  
Y-  
Z-

NOTM510  
OBJECTO-Fragmento de alabarda  
MATERIAL-Silex  
QUADRADO-? (Corredor)  
X-  
Y-  
Z-

NOTM511  
OBJECTO-Ponta de seta  
MATERIAL-Silex  
QUADRADO-? (Corredor)  
X-  
Y-  
Z-

NOTM512  
OBJECTO-Ponta de seta  
MATERIAL-Silex  
QUADRADO-? (Corredor)  
X-  
Y-  
Z-

NOTM513  
OBJECTO-Fragmento de alabarda  
MATERIAL-Silex  
QUADRADO-? (Corredor)  
X-  
Y-  
Z-

NOTM514  
OBJECTO-Ponta de seta  
MATERIAL-Silex  
QUADRADO-? (Corredor)  
X-  
Y-  
Z-

NOTM515  
OBJECTO-Ponta de seta  
MATERIAL-Silex  
QUADRADO-? (Corredor)  
X-  
Y-  
Z-

NOTM516  
OBJECTO-Ponta de seta  
MATERIAL-Silex  
QUADRADO-? (Corredor)  
X-  
Y-  
Z-

NOTM517  
OBJECTO-Fragmento de lâmina  
MATERIAL-Silex  
QUADRADO-? (Corredor)  
X-  
Y-  
Z-

NOTM518  
OBJECTO-Fragmento de lâmina  
MATERIAL-Silex  
QUADRADO-? (Corredor)  
X-  
Y-  
Z-

NOTM519  
OBJECTO-Fragmento de lâmina  
MATERIAL-Silex  
QUADRADO-? (Corredor)  
X-  
Y-  
Z-

NOTM520  
OBJECTO-  
MATERIAL-  
QUADRADO-  
X-  
Y-  
Z-

NOTM521  
OBJECTO-  
MATERIAL-  
QUADRADO-  
X-  
Y-  
Z-

ANTA  
do  
**TAPADÃO DA RELVA**



ANTA DO TAPADAO DA RELVA

N0TR1  
 OBJECTO-Taça carenada  
 MATERIAL-Cerâmica  
 QUADRADO-?  
 X-  
 Y-  
 Z-

N0TR2  
 OBJECTO-Vaso semi-esférico  
 MATERIAL-Cerâmica  
 QUADRADO-?  
 X-  
 Y-  
 Z-

N0TR3  
 OBJECTO-Taça carenada  
 MATERIAL-Cerâmica  
 QUADRADO-?  
 X-  
 Y-  
 Z-

N0TR4  
 OBJECTO-Taça carenada  
 MATERIAL-Cerâmica  
 QUADRADO-?  
 X-  
 Y-  
 Z-

N0TR5  
 OBJECTO-Taça semi-esférica  
 MATERIAL-Cerâmica  
 QUADRADO-?  
 X-  
 Y-  
 Z-

N0TR6  
 OBJECTO-Fragmento de taça  
 MATERIAL-Cerâmica  
 QUADRADO-?  
 X-  
 Y-  
 Z-

N0TR7  
 OBJECTO-Taça carenada com mamilos  
 MATERIAL-Cerâmica  
 QUADRADO-?  
 X-  
 Y-  
 Z-

N0TR8  
 OBJECTO-Taça  
 MATERIAL-Cerâmica  
 QUADRADO-?  
 X-  
 Y-  
 Z-

N0TR9  
 OBJECTO-Taça carenada  
 MATERIAL-Cerâmica  
 QUADRADO-?  
 X-  
 Y-  
 Z-

N0TR10  
 OBJECTO-Taça semi-esférica  
 MATERIAL-Cerâmica  
 QUADRADO-?  
 X-  
 Y-  
 Z-

N0TR11  
 OBJECTO-Vaso  
 MATERIAL-Cerâmica  
 QUADRADO-?  
 X-  
 Y-  
 Z-

N0TR12  
 OBJECTO-Vaso de fundo Plano  
 MATERIAL-Cerâmica  
 QUADRADO-?  
 X-  
 Y-  
 Z-

NOTR13  
OBJECTO-Vaso esférico  
MATERIAL-Cerâmica  
QUADRADO-?  
X-  
Y-  
Z-

NOTR14  
OBJECTO-Taca semi-esférica  
MATERIAL-Cerâmica  
QUADRADO-?  
X-  
Y-  
Z-

NOTR15  
OBJECTO-Vaso de fundo plano  
MATERIAL-Cerâmica  
QUADRADO-?  
X-  
Y-  
Z-

NOTR16  
OBJECTO-Taca semi-esférica  
MATERIAL-Cerâmica  
QUADRADO-?  
X-  
Y-  
Z-

NOTR17  
OBJECTO-Taca carenada  
MATERIAL-Cerâmica  
QUADRADO-?  
X-  
Y-  
Z-

NOTR18  
OBJECTO-Taca carenada  
MATERIAL-Cerâmica  
QUADRADO-?  
X-  
Y-  
Z-

NOTR19  
OBJECTO-Fragmento de taca semi-esférica  
MATERIAL-Cerâmica  
QUADRADO-?  
X-  
Y-  
Z-

NOTR20  
OBJECTO-Taca semi-esférica  
MATERIAL-?  
QUADRADO-  
X-  
Y-  
Z-

NOTR21  
OBJECTO-Taca acampanada  
MATERIAL-Cerâmica  
QUADRADO-?  
X-  
Y-  
Z-

NOTR23  
OBJECTO-Taca semi-esférica  
MATERIAL-Cerâmica  
QUADRADO-?  
X-  
Y-  
Z-

NOTR24  
OBJECTO-Idolo-placa  
MATERIAL-Xisto  
QUADRADO-?  
X-  
Y-  
Z-

NOTR25  
OBJECTO-Fragmento de idolo-placa  
MATERIAL-Xisto  
QUADRADO-?  
X-  
Y-  
ZZ-

NqTR26  
OBJECTO-Idolo-placa  
MATERIAL-Grés  
QUADRADO-?  
X-  
Y-  
Z-

NqTR27  
OBJECTO-Idolo-placa  
MATERIAL-Xisto  
QUADRADO-?  
X-  
Y-  
Z-

NqTR28  
OBJECTO-Idolo-placa  
MATERIAL-Xisto  
QUADRADO-?  
X-  
Y-  
Z-

NqTR29  
OBJECTO-Fragmento de idolo-placa  
MATERIAL-Xisto  
QUADRADO-?  
X-  
Y-  
Z-

NqTR31  
OBJECTO-Fragmento de idolo-placa  
MATERIAL-Xisto  
QUADRADO-?  
X-  
Y-  
Z-

NqTR33  
OBJECTO-Machado  
MATERIAL-Anfibolite  
QUADRADO-?  
X-  
Y-  
Z-

NqTR34  
OBJECTO-Machado  
MATERIAL-Anfibolite  
QUADRADO-?  
X-  
Y-  
Z-

NqTR35  
OBJECTO-Machado  
MATERIAL-Anfibolite  
QUADRADO-?  
X-  
Y-  
Z-

NqTR36  
OBJECTO-Machado  
MATERIAL-Anfibolite  
QUADRADO-?  
X-  
Y-  
Z-

NqTR37  
OBJECTO-Machado  
MATERIAL-Anfibolite  
QUADRADO-?  
X-  
Y-  
Z-

NqTR38  
OBJECTO-Machado  
MATERIAL-Anfibolite  
QUADRADO-?  
X-  
Y-  
Z-

NqTR39  
OBJECTO-Machado  
MATERIAL-Anfibolite  
QUADRADO-?  
X-  
Y-  
Z-



NQTR40  
OBJECTO-Enx6  
MATERIAL-Anfibolite  
QUADRADO-?  
X-  
Y-  
Z-

NQTR41  
OBJECTO-Ponta de seta  
MATERIAL-Quartzo filoniano  
QUADRADO-?  
X-  
Y-  
Z-

NQTR42  
OBJECTO-Ponta de seta  
MATERIAL-Quartzo hialino  
QUADRADO-?  
X-  
Y-  
Z-

NQTR43  
OBJECTO-Ponta de seta  
MATERIAL-Xisto Jaspoido  
QUADRADO-?  
X-  
Y-  
Z-

NQTR44  
OBJECTO-Ponta de seta  
MATERIAL-Quartzo filoniano  
QUADRADO-?  
X-  
Y-  
Z-

NQTR45  
OBJECTO-Ponta seta  
MATERIAL-Quartzo filoniano  
QUADRADO-?  
X-  
Y-  
Z-

NQTR46  
OBJECTO-Ponta de seta  
MATERIAL-Quartzo filoniano  
QUADRADO-?  
X-  
Y-  
Z-

NQTR47  
OBJECTO-Ponta de seta  
MATERIAL-Quartzo filoniano  
QUADRADO-?  
X-  
Y-  
Z-

NQTR48  
OBJECTO-Fragmento de ponta de seta  
MATERIAL-Xisto Jaspoido  
QUADRADO-?  
X-  
Y-  
Z-

NQTR49  
OBJECTO-Ponta de seta  
MATERIAL-Silex  
QUADRADO-?  
X-  
Y-  
Z-

NQTR50  
OBJECTO-Ponta de seta  
MATERIAL-Silex  
QUADRADO-?  
X-  
Y-  
Z-

NQTR51  
OBJECTO-Ponta de seta  
MATERIAL-Silex  
QUADRADO-?  
X-  
Y-  
Z-

NqTR52  
OBJECTO-Ponta de seta  
MATERIAL-Silex  
QUADRADO-?  
X-  
Y-  
Z-

NqTR53  
OBJECTO-Conta de colar  
MATERIAL-Xisto  
QUADRADO-  
X-  
Y-  
Z-

NqTR54  
OBJECTO-Ponta de seta  
MATERIAL-Silex  
QUADRADO-?  
X-  
Y-  
Z-

NqTR55  
OBJECTO-Ponta de seta  
MATERIAL-Silex  
QUADRADO-?  
X-  
Y-  
Z-

NqTR56  
OBJECTO-Ponta de seta  
MATERIAL-Silex  
QUADRADO-?  
X-  
Y-  
Z-

NqTR57  
OBJECTO-Ponta de seta  
MATERIAL-Silex  
QUADRADO-?  
X-  
Y-  
Z-

NqTR58  
OBJECTO-Ponta de seta  
MATERIAL-Silex  
QUADRADO-?  
X-  
Y-  
Z-

NqTR58  
OBJECTO-Ponta de seta  
MATERIAL-Silex  
QUADRADO-?  
X-  
Y-  
Z-

NqTR59  
OBJECTO-Ponta de seta  
MATERIAL-Silex  
QUADRADO-?  
X-  
Y-  
Z-

NqTR59  
OBJECTO-Ponta de seta  
MATERIAL-Silex  
QUADRADO-?  
X-  
Y-  
Z-

NqTR60  
OBJECTO-Ponta de seta  
MATERIAL-Silex  
QUADRADO-?  
X-  
Y-  
Z-

NqTR61  
OBJECTO-Ponta de seta  
MATERIAL-Quartzto hialino  
QUADRADO-?  
X-  
Y-  
Z-

NGTR62  
OBJECTO-Ponta de seta  
MATERIAL-Quartzo filoniano  
QUADRADO-?  
X-  
Y-  
Z-

NGTR63  
OBJECTO-Ponta de seta  
MATERIAL-Quartzo hialino  
QUADRADO-?  
X-  
Y-  
Z-

NGTR64  
OBJECTO-Ponta de seta  
MATERIAL-Quartzo filoniano  
QUADRADO-?  
X-  
Y-  
Z-

NGTR65  
OBJECTO-Ponta de seta  
MATERIAL-Xisto jaspoide  
QUADRADO-?  
X-  
Y-  
Z-

NGTR66  
OBJECTO-Ponta de seta  
MATERIAL-Silex  
QUADRADO-?  
X-  
Y-  
Z-

NGTR67  
OBJECTO-Ponta de seta  
MATERIAL-Xisto jaspoide  
QUADRADO-?  
X-  
Y-  
Z-

NGTR68  
OBJECTO-Ponta de seta  
MATERIAL-Silex  
QUADRADO-?  
X-  
Y-  
Z-

NGTR69  
OBJECTO-Ponta de seta  
MATERIAL-Silex  
QUADRADO-?  
X-  
Y-  
Z-

NGTR70  
OBJECTO-Ponta de seta  
MATERIAL-Silex  
QUADRADO-?  
X-  
Y-  
Z-

NGTR71  
OBJECTO-Ponta de seta  
MATERIAL-Silex  
QUADRADO-?  
X-  
Y-  
Z-

NGTR72  
OBJECTO-Ponta de seta  
MATERIAL-Silex  
QUADRADO-?  
X-  
Y-  
Z-

NGTR73  
OBJECTO-Ponta de seta  
MATERIAL-Silex  
QUADRADO-?  
X-  
Y-  
Z-

NºTR74  
OBJECTO-Ponta de seta  
MATERIAL-Silex  
QUADRADO-?  
X-  
Y-  
Z-

NºTR75  
OBJECTO-Ponta de seta  
MATERIAL-Silex  
QUADRADO-?  
X-  
Y-  
Z-

NºTR76  
OBJECTO-Ponta de seta  
MATERIAL-Silex  
QUADRADO-?  
X-  
Y-  
Z-

NºTR77  
OBJECTO-Ponta de seta  
MATERIAL-Silex  
QUADRADO-?  
X-  
Y-  
Z-

NºTR78  
OBJECTO-Ponta de seta  
MATERIAL-Silex  
QUADRADO-?  
X-  
Y-  
Z-

NºTR79  
OBJECTO-Ponta de seta  
MATERIAL-Quartzo filoniano  
QUADRADO-?  
X-  
Y-  
Z-

NºTR80  
OBJECTO-Ponta de seta  
MATERIAL-Silex  
QUADRADO-?  
X-  
Y-  
Z-

NºTR81  
OBJECTO-Ponta de seta  
MATERIAL-Quartzo filoniano  
QUADRADO-?  
X-  
Y-  
Z-

NºTR82  
OBJECTO-Ponta de seta  
MATERIAL-Quartzo filoniano  
QUADRADO-?  
X-  
Y-  
Z-

NºTR83  
OBJECTO-Ponta de seta fragmentada  
MATERIAL-Quartzo filoniano  
QUADRADO-?  
X-  
Y-  
Z-

NºTR84  
OBJECTO-Ponta de seta  
MATERIAL-Xisto  
QUADRADO-?  
X-  
Y-  
Z-

NºTR85  
OBJECTO-Ponta de seta  
MATERIAL-Silex  
QUADRADO-?  
X-  
Y-  
Z-

NGTR86  
OBJECTO-TPonta de seta  
MATERIAL-Silex  
QUADRADO-?  
X-  
Y-  
Z-

NGTR87  
OBJECTO-Ponta de seta  
MATERIAL-Silex  
QUADRADO-?  
X-  
Y-  
Z-

NGTR88  
OBJECTO-Ponta de seta  
MATERIAL-Silex  
QUADRADO-?  
X-  
Y-  
Z-

NGTR89  
OBJECTO-Ponta de seta  
MATERIAL-Silex  
QUADRADO-?  
X-  
Y-  
Z-

NGTR90  
OBJECTO-Ponta de seta  
MATERIAL-Silex  
QUADRADO-?  
X-  
Y-  
Z-

NGTR91  
OBJECTO-Ponta de seta  
MATERIAL-Silex  
QUADRADO-?  
X-  
Y-  
Z-

NGTR92  
OBJECTO-Ponta de seta  
MATERIAL-Quartzo filoniano  
QUADRADO-?  
X-  
Y-  
Z-

NGTR93  
OBJECTO-Ponta de seta  
MATERIAL-Quartzo hialino  
QUADRADO-?  
X-  
Y-  
Z-

NGTR94  
OBJECTO-Ponta de seta  
MATERIAL-Xisto jaspoido  
QUADRADO-?  
X-  
Y-  
Z-

NGTR95  
OBJECTO-Fragmento de ponta de seta  
MATERIAL-Quartzo filoniano  
QUADRADO-?  
X-  
Y-  
Z-

NGTR96  
OBJECTO-Ponta de seta  
MATERIAL-Quartzo filoniano  
QUADRADO-?  
X-  
Y-  
Z-

NGTR97  
OBJECTO-Ponta de seta  
MATERIAL-Xisto jaspoido  
QUADRADO-?  
X-  
Y-  
Z-

NqTR98  
OBJECTO-Ponta de seta  
MATERIAL-Silex  
QUADRADO-?  
X-  
Y-  
Z-

NqTR99  
OBJECTO-Ponta de seta  
MATERIAL-Silex  
QUADRADO-?  
X-  
Y-  
Z-

NqTR100  
OBJECTO-Ponta de seta  
MATERIAL-Xisto jaspoide  
QUADRADO-?  
X-  
Y-  
Z-

NqTR101  
OBJECTO-Ponta de seta  
MATERIAL-Xisto jaspoide  
QUADRADO-?  
X-  
Y-  
Z-

NqTR102  
OBJECTO-Ponta de seta  
MATERIAL-Xisto jaspoide  
QUADRADO-?  
X-  
Y-  
Z-

NqTR103  
OBJECTO-Ponta de seta  
MATERIAL-Xisto jaspoide  
QUADRADO-?  
X-  
Y-  
Z-

NqTR104  
OBJECTO-Ponta de seta  
MATERIAL-Quartzo filoniano  
QUADRADO-?  
X-  
Y-  
Z-

NqTR105  
OBJECTO-Ponta de seta  
MATERIAL-Quartzo filoniano  
QUADRADO-?  
X-  
Y-  
Z-

NqTR106  
OBJECTO-Ponta de seta  
MATERIAL-Silex  
QUADRADO-?  
X-  
Y-  
Z-

NqTR107  
OBJECTO-Ponta de seta  
MATERIAL-Silex  
QUADRADO-?  
X-  
Y-  
Z-

NqTR108  
OBJECTO-Ponta de seta  
MATERIAL-Silex  
QUADRADO-?  
X-  
Y-  
Z-

NqTR109  
OBJECTO-Ponta de seta  
MATERIAL-Silex  
QUADRADO-?  
X-  
Y-  
Z-

NGTR110  
OBJECTO-Ponta de seta  
MATERIAL-Xisto Jaspoida  
QUADRADO-?  
X-  
Y-  
Z-

NGTR111  
OBJECTO-Ponta de seta  
MATERIAL-Silex  
QUADRADO-?  
X-  
Y-  
Z-

NGTR112  
OBJECTO-Ponta de seta  
MATERIAL-Silex  
QUADRADO-?  
X-  
Y-  
Z-

NGTR113  
OBJECTO-Ponta de seta  
MATERIAL-Xisto Jaspoida  
QUADRADO-?  
X-  
Y-  
Z-

NGTR114  
OBJECTO-Ponta de seta  
MATERIAL-Quartzo filoniano  
QUADRADO-?  
X-  
Y-  
Z-

NGTR115  
OBJECTO-Ponta de seta  
MATERIAL-Quartzo filoniano  
QUADRADO-?  
X-  
Y-  
Z-

NGTR116  
OBJECTO-Ponta de seta  
MATERIAL-Quartzo filoniano  
QUADRADO-?  
X-  
Y-  
Z-

NGTR117  
OBJECTO-Ponta de seta  
MATERIAL-Xisto jaspoida  
QUADRADO-?  
X-  
Y-  
Z-

NGTR118  
OBJECTO-Ponta de seta  
MATERIAL-Silex  
QUADRADO-?  
X-  
Y-  
Z-

NGTR119  
OBJECTO-Conta de colar  
MATERIAL-Xisto  
QUADRADO-?  
X-  
Y-  
Z-

NGTR120  
OBJECTO-Geométrico  
MATERIAL-Silex  
QUADRADO-?  
X-  
Y-  
Z-

NGTR122  
OBJECTO-Geométrico  
MATERIAL-Silex  
QUADRADO-?  
X-  
Y-  
Z-

NoTR123  
OBJETO-Fragmento de lámina  
MATERIAL-Sílex  
QUADRADO-?  
X-  
Y-  
Z-

NoTR126  
OBJETO-Fragmento de lámina  
MATERIAL-Sílex  
QUADRADO-?  
X-  
Y-  
Z-

NoTR127  
OBJETO-Fragmento de lámina  
MATERIAL-Sílex  
QUADRADO-?  
X-  
Y-  
Z-

NoTR129  
OBJETO-Fragmento de lámina  
MATERIAL-Sílex  
QUADRADO-?  
X-  
Y-  
Z-

NoTR131  
OBJETO-Geométrico  
MATERIAL-Sílex  
QUADRADO-?  
X-  
Y-  
Z-

NoTR144  
OBJETO-Geométrico  
MATERIAL-Sílex  
QUADRADO-?  
X-  
Y-  
Z-

NoTR146  
OBJETO-Fragmento de lámina  
MATERIAL-Sílex  
QUADRADO-?  
X-  
Y-  
Z-

NoTR148  
OBJETO-Conta de colar  
MATERIAL-Ambar  
QUADRADO-?  
X-  
Y-  
Z-

NoTR149  
OBJETO-Conta de colar  
MATERIAL-Xisto  
QUADRADO-?  
X-  
Y-  
Z-

NoTR150  
OBJETO-Conta de colar  
MATERIAL-Xisto  
QUADRADO-?  
X-  
Y-  
Z-

NoTR151  
OBJETO-Conta de colar  
MATERIAL-Xisto  
QUADRADO-?  
X-  
Y-  
Z-

NoTR152  
OBJETO-Conta de colar  
MATERIAL-Xisto  
QUADRADO-?  
X-  
Y-  
Z-



NETR153  
OBJECTO-Conta de colar  
MATERIAL-Xisto  
QUADRADO-?  
X-  
Y-  
Z-

NETR154  
OBJECTO-Conta de colar  
MATERIAL-Xisto  
QUADRADO-?  
X-  
Y-  
Z-

NETR155  
OBJECTO-Conta de colar  
MATERIAL-Xisto  
QUADRADO-?  
X-  
Y-  
Z-

NETR156  
OBJECTO-Conta de colar  
MATERIAL-Xisto  
QUADRADO-?  
X-  
Y-  
Z-

NETR157  
OBJECTO-Conta de colar  
MATERIAL-Xisto  
QUADRADO-?  
X-  
Y-  
Z-

NETR158  
OBJECTO-Conta de colar  
MATERIAL-Xisto  
QUADRADO-?  
X-  
Y-  
Z-

NETR159  
OBJECTO-Conta de colar  
MATERIAL-Xisto  
QUADRADO-?  
X-  
Y-  
Z-

NETR160  
OBJECTO-Conta de colar  
MATERIAL-Xisto  
QUADRADO-?  
X-  
Y-  
Z-

NETR161  
OBJECTO-Conta de colar  
MATERIAL-Xisto  
QUADRADO-?  
X-  
Y-  
Z-

NETR162  
OBJECTO-Conta de colar  
MATERIAL-Xisto  
QUADRADO-?  
X-  
Y-  
Z-

NETR163  
OBJECTO-Conta de colar  
MATERIAL-Xisto  
QUADRADO-?  
X-  
Y-  
Z-

NETR164  
OBJECTO-Conta de colar  
MATERIAL-Xisto  
QUADRADO-?  
X-  
Y-  
Z-

NøTR171  
OBJECTO-Conta de colar  
MATERIAL-Xisto  
QUADRADO-?  
X-  
Y-  
Z-

NøTR172  
OBJECTO-Conta de colar  
MATERIAL-Xisto  
QUADRADO-?  
X-  
Y-  
Z-

NøTR173  
OBJECTO-Conta de colar  
MATERIAL-Xisto  
QUADRADO-?  
X-  
Y-  
Z-

NøTR174  
OBJECTO-Conta de colar  
MATERIAL-Xisto  
QUADRADO-?  
X-  
Y-  
Z-

NøTR175  
OBJECTO-Conta de colar  
MATERIAL-Xisto  
QUADRADO-?  
X-  
Y-  
Z-

NøTR176  
OBJECTO-Conta de colar  
MATERIAL-Xisto  
QUADRADO-?  
X-  
Y-  
Z-

NøTR165  
OBJECTO-Conta de colar  
MATERIAL-Xisto  
QUADRADO-?  
X-  
Y-  
Z-

NøTR166  
OBJECTO-Conta de colar  
MATERIAL-Xisto  
QUADRADO-?  
X-  
Y-  
Z-

NøTR167  
OBJECTO-Conta de colar  
MATERIAL-Xisto  
QUADRADO-?  
X-  
Y-  
Z-

NøTR168  
OBJECTO-Conta de colar  
MATERIAL-Xisto  
QUADRADO-?  
X-  
Y-  
Z-

NøTR169  
OBJECTO-Conta de colar  
MATERIAL-Xisto  
QUADRADO-?  
X-  
Y-  
Z-

NøTR170  
OBJECTO-Conta de colar  
MATERIAL-Xisto  
QUADRADO-?  
X-  
Y-  
Z-

NETR177  
OBJECTO-Conta de colar  
MATERIAL-Xisto  
QUADRADO-?  
X-  
Y-  
Z-

NETR178  
OBJECTO-Conta de colar  
MATERIAL-Xisto  
QUADRADO-?  
X-  
Y-  
Z-

NETR179  
OBJECTO-Conta de colar  
MATERIAL-Xisto  
QUADRADO-?  
X-  
Y-  
Z-

NETR180  
OBJECTO-Conta de colar  
MATERIAL-Xisto  
QUADRADO-?  
X-  
Y-  
Z-

NETR181  
OBJECTO-Conta de colar  
MATERIAL-Xisto  
QUADRADO-?  
X-  
Y-  
Z-

NETR182  
OBJECTO-Conta de colar  
MATERIAL-Xisto  
QUADRADO-?  
X-  
Y-  
Z-

NETR183  
OBJECTO-Conta de colar  
MATERIAL-Xisto  
QUADRADO-?  
X-  
Y-  
Z-

NETR184  
OBJECTO-Conta de colar  
MATERIAL-Xisto  
QUADRADO-?  
X-  
Y-  
Z-

NETR185  
OBJECTO-Conta de colar  
MATERIAL-Xisto  
QUADRADO-?  
X-  
Y-  
Z-

NETR186  
OBJECTO-Conta de colar  
MATERIAL-Xisto  
QUADRADO-?  
X-  
Y-  
Z-

NETR187  
OBJECTO-Conta de colar  
MATERIAL-Xisto  
QUADRADO-?  
X-  
Y-  
Z-

NETR188  
OBJECTO-Conta de colar  
MATERIAL-Xisto  
QUADRADO-?  
X-  
Y-  
Z-

NqTR189	OBJECTO-Conta de colar	NqTR189	OBJECTO-Conta de colar
	MATERIAL-Xisto		MATERIAL-Xisto
	QUADRADO-?		QUADRADO-?
X-		X-	
Y-		Y-	
Z-		Z-	
NqTR190	OBJECTO-Conta de colar	NqTR196	OBJECTO-Conta de colar
	MATERIAL-Xisto		MATERIAL-Xisto
	QUADRADO-?		QUADRADO-?
X-		X-	
Y-		Y-	
Z-		Z-	
NqTR191	OBJECTO-Conta de colar	NqTR197	OBJECTO-Fragmento de taça
	MATERIAL-Xisto		MATERIAL-Cerâmica
	QUADRADO-?		QUADRADO-?
X-		X-	
Y-		Y-	
Z-		Z-	
NqTR192	OBJECTO-Conta de colar	Nq	OBJECTO-
	MATERIAL-Xisto		MATERIAL-
	QUADRADO-?		QUADRADO-
X-		X-	
Y-		Y-	
Z-		Z-	
NqTR193	OBJECTO-Conta de colar	Nq	OBJECTO-
	MATERIAL-Xisto		MATERIAL-
	QUADRADO-?		QUADRADO-
X-		X-	
Y-		Y-	
Z-		Z-	
NqTR194	OBJECTO-Conta de colar	Nq	OBJECTO-
	MATERIAL-Xisto		MATERIAL-
	QUADRADO-?		QUADRADO-
X-		X-	
Y-		Y-	
Z-		Z-	



**ANTA**  
**do**  
**VALE DA ESTRADA**



ANTA DO VALE DA ESTRADA OU DO ZE GODINHO

NGAVE1	OBJECTO-Fragmento de lâmina	NGAVE14	OBJECTO-Ponta de seta
	MATERIAL-Silex		MATERIAL-Silex
	QUADRADO-(Câmara)		QUADRADO-(Câmara)
X-		X-	
Y-		Y-	
Z-		Z-	
NGAVE2	OBJECTO-Fragmento de lâmina	NGAVE15	OBJECTO-Ponta de seta
	MATERIAL-Silex		MATERIAL-Silex
	QUADRADO-(Câmara)		QUADRADO-(Câmara)
X-		X-	
Y-		Y-	
Z-		Z-	
NGAVE3	OBJECTO-Fragmento de lâmina	NGAVE16	OBJECTO-Ponta de seta
	MATERIAL-Silex		MATERIAL-Silex
	QUADRADO-(Câmara)		QUADRADO-(Câmara)
X-		X-	
Y-		Y-	
Z-		Z-	
NGAVE4	OBJECTO-Fragmento de lâmina	NGAVE17	OBJECTO-Ponta de seta
	MATERIAL-Silex		MATERIAL-Silex
	QUADRADO-(Câmara)		QUADRADO-(Câmara)
X-		X-	
Y-		Y-	
Z-		Z-	
NGAVE5	OBJECTO-Fragmento de idolo-placa	NGAVE18	OBJECTO-Ponta de seta
	MATERIAL-Grés		MATERIAL-Silex
	QUADRADO-(Câmara)		QUADRADO-(Câmara)
X-		X-	
Y-		Y-	
Z-		Z-	
NGAVE7	OBJECTO-Fragmento de idolo-placa	NGAVE19	OBJECTO-Ponta de seta
	MATERIAL-Xisto		MATERIAL-Quartzo filoniano
	QUADRADO-(Câmara)		QUADRADO-(Câmara)
X-		X-	
Y-		Y-	
Z-		Z-	





N0AVE20  
OBJECTO-Ponta de seta  
MATERIAL-Sílex  
QUADRADO-(Câmara)  
X-  
Y-  
Z-

N0AVE21  
OBJECTO-Ponta de seta  
MATERIAL-Sílex (cortex)  
QUADRADO-(Câmara)  
X-  
Y-  
Z-

N0AVE22  
OBJECTO-Taça carenada  
MATERIAL-Cerâmica  
QUADRADO-(Câmara)  
X-  
Y-  
Z-

N0AVE23  
OBJECTO-Taça carenada  
MATERIAL-Cerâmica  
QUADRADO-(Câmara)  
X-  
Y-  
Z-

N0AVE24  
OBJECTO-Taça carenada  
MATERIAL-Cerâmica  
QUADRADO-(Câmara)  
X-  
Y-  
Z-

N0AVE25  
OBJECTO-Taça carenada  
MATERIAL-Cerâmica  
QUADRADO-(Câmara)  
X-  
Y-  
Z-

N0AVE26  
OBJECTO-Taça  
MATERIAL-Cerâmica  
QUADRADO-(Câmara)  
X-  
Y-  
Z-

N0AVE27  
OBJECTO-Taça carenada  
MATERIAL-Cerâmica  
QUADRADO-(Câmara)  
X-  
Y-  
Z-

N0AVE28  
OBJECTO-Taça  
MATERIAL-Cerâmica  
QUADRADO-(Câmara)  
X-  
Y-  
Z-

N0AVE29  
OBJECTO-Taça  
MATERIAL-Cerâmica  
QUADRADO-(Câmara)  
X-  
Y-  
Z-

N0AVE30  
OBJECTO-Taça carenada  
MATERIAL-Cerâmica  
QUADRADO-(Câmara)  
X-  
Y-  
Z-

N0AVE31  
OBJECTO-Taça semi-esférica  
MATERIAL-Cerâmica  
QUADRADO-(Câmara)  
X-  
Y-  
Z-

NOAVE32  
OBJECTO-Fragmento de taça semi-esférica  
MATERIAL-Cerâmica  
QUADRADO-(Câmara)  
X-  
Y-  
Z-

NOAVE33  
OBJECTO-Fragmento de taça  
MATERIAL-Cerâmica  
QUADRADO-(Câmara)  
X-  
Y-  
Z-

NOAVE35  
OBJECTO-Fragmento de taça carenada  
MATERIAL-Cerâmica  
QUADRADO-(Câmara)  
X-  
Y-  
Z-

NOAVE36  
OBJECTO-Fragmento de taça  
MATERIAL-Cerâmica  
QUADRADO-(Câmara)  
X-  
Y-  
Z-

NOAVE38  
OBJECTO-Conta de colar  
MATERIAL-Xisto  
QUADRADO-(Câmara)  
X-  
Y-  
Z-

NOAVE39  
OBJECTO-Conta de colar  
MATERIAL-Xisto  
QUADRADO-(Câmara)  
X-  
Y-

NOAVE40  
OBJECTO-Conta de colar  
MATERIAL-Xisto  
QUADRADO-(Câmara)  
X-  
Y-  
Z-

NOAVE41  
OBJECTO-Conta de colar  
MATERIAL-Xisto  
QUADRADO-(Câmara)  
X-  
Y-  
Z-

NOAVE42  
OBJECTO-Conta de colar  
MATERIAL-Xisto  
QUADRADO-(Câmara)  
X-  
Y-  
Z-

NOAVE43  
OBJECTO-Conta de colar  
MATERIAL-Xisto  
QUADRADO-(Câmara)  
X-  
Y-  
Z-

NOAVE44  
OBJECTO-Conta de colar  
MATERIAL-Xisto  
QUADRADO-(Câmara)  
X-  
Y-  
Z-

NOAVE45  
OBJECTO-Conta de colar  
MATERIAL-Xisto  
QUADRADO-(Câmara)  
X-  
Y-  
Z-

NoAVE46  
OBJECTO-Conta de colar  
MATERIAL-Xisto  
QUADRADO-(Cámara)  
X-  
Y-  
Z-

NoAVE47  
OBJECTO-Conta de colar  
MATERIAL-Xisto  
QUADRADO-(Cámara)  
X-  
Y-  
Z-

NoAVE48  
OBJECTO-Conta de colar  
MATERIAL-Xisto  
QUADRADO-(Cámara)  
X-  
Y-  
Z-

NoAVE49  
OBJECTO-Conta de colar  
MATERIAL-Xisto  
QUADRADO-(Cámara)  
X-  
Y-  
Z-

NoAVE50  
OBJECTO-Conta de colar  
MATERIAL-Xisto  
QUADRADO-(Cámara)  
X-  
Y-  
Z-

NoAVE51  
OBJECTO-Conta de colar  
MATERIAL-Xisto  
QUADRADO-(Cámara)  
X-  
Y-  
Z-

NoAVE52  
OBJECTO-Conta de colar  
MATERIAL-Xisto  
QUADRADO-(Cámara)  
X-  
Y-  
Z-

NoAVE53  
OBJECTO-Conta de colar  
MATERIAL-Xisto  
QUADRADO-(Cámara)  
X-  
Y-  
Z-

NoAVE54  
OBJECTO-Conta de colar  
MATERIAL-Xisto  
QUADRADO-(Cámara)  
X-  
Y-  
Z-

NoAVE55  
OBJECTO-Conta de colar  
MATERIAL-Xisto  
QUADRADO-(Cámara)  
X-  
Y-  
Z-

NoAVE56  
OBJECTO-Conta de colar  
MATERIAL-Xisto  
QUADRADO-(Cámara)  
X-  
Y-  
Z-

NoAVE57  
OBJECTO-Conta de colar  
MATERIAL-Xisto  
QUADRADO-(Cámara)  
X-  
Y-  
Z-

NEAVE58  
OBJECTO-Conta de colar  
MATERIAL-Xisto  
QUADRADO-(Câmara)  
X-  
Y-  
Z-

NEAVE59  
OBJECTO-Conta de colar  
MATERIAL-Xisto  
QUADRADO-(Câmara)  
X-  
Y-  
Z-

NEAVE60  
OBJECTO-Conta de colar  
MATERIAL-Xisto  
QUADRADO-(Câmara)  
X-  
Y-  
Z-

NEAVE61  
OBJECTO-Conta de colar  
MATERIAL-Xisto  
QUADRADO-(Câmara)  
X-  
Y-  
Z-

NEAVE62  
OBJECTO-Conta de colar  
MATERIAL-Xisto  
QUADRADO-(Câmara)  
X-  
Y-  
Z-

NEAVE63  
OBJECTO-Conta de colar  
MATERIAL-Xisto  
QUADRADO-(Câmara)  
X-  
Y-  
Z-

NEAVE64  
OBJECTO-Conta de colar  
MATERIAL-Xisto  
QUADRADO-(Câmara)  
X-  
Y-  
Z-

NEAVE65  
OBJECTO-Conta de colar  
MATERIAL-Xisto  
QUADRADO-(Câmara)  
X-  
Y-  
Z-

NEAVE66  
OBJECTO-Fragmento de vaso esférico  
MATERIAL-Cerâmica  
QUADRADO-(Câmara)  
X-  
Y-  
Z-

NEAVE67  
OBJECTO-Taça carenada  
MATERIAL-Cerâmica  
QUADRADO-(Câmara)  
X-  
Y-  
Z-

NEAVE68  
OBJECTO-Fragmento de lâmina  
MATERIAL-Silex  
QUADRADO-(Câmara)  
X-  
Y-  
Z-

NE  
OBJECTO-  
MATERIAL-  
QUADRADO-  
X-  
Y-  
Z-

MENIR  
do  
**CARVALHAL**



N9MC1  
OBJETO-Objecto de pedra polida  
MATERIAL-Xisto  
QUADRADO-  
X-  
Y-  
Z-(superficie)

N9MC2  
OBJETO-Perutor  
MATERIAL-Quartzito  
QUADRADO-I9  
X-192cm  
Y-106cm  
Z-189cm

N9MC3  
OBJETO-Perutor  
MATERIAL-Quartzito  
QUADRADO-H10  
X-30cm  
Y-140cm  
Z-157cm

N9MC4  
OBJETO-Perutor  
MATERIAL-Quartzito  
QUADRADO-H9  
X-106cm  
Y-20cm  
Z-157cm

N9MC5  
OBJETO-Perutor  
MATERIAL-Quartzito  
QUADRADO-I10  
X-40cm  
Y-45cm  
Z-161cm

N9  
OBJETO-  
MATERIAL-  
QUADRADO-  
X-  
Y-  
Z-





ANTA  
da  
**FONTE DA PIPA**



NGFP13  
OBJECTO-Geométrico  
MATERIAL-Silex  
QUADRADO-J11  
X-40cm  
Y-140cm  
Z-100cm

NGFP14  
OBJECTO-Geométrico  
MATERIAL-Silex  
QUADRADO-J12  
X-  
Y-  
Z-100cm

NGFP15  
OBJECTO-Fragmento de machado (talão)  
MATERIAL-Anfibolite  
QUADRADO-I12  
X-  
Y-  
Z-100cm

NGFP16  
OBJECTO-Machado  
MATERIAL-Anfibolite  
QUADRADO-J10  
X-57cm  
Y-79cm  
Z-80cm

NGFP17  
OBJECTO-Machado  
MATERIAL-Anfibolite  
QUADRADO-J12  
X-10cm  
Y-25cm  
Z-100cm

NGFP18  
OBJECTO-Machado  
MATERIAL-Anfibolite  
QUADRADO-J12  
X-28cm  
Y-13cm  
Z-100cm

NGFP20  
OBJECTO-Fragmento de idolo-placa (?)  
MATERIAL-Grés  
QUADRADO-J11  
X-80cm  
Y-140cm  
Z-98cm

NGFP21  
OBJECTO-Idolo-placa  
MATERIAL-Grés  
QUADRADO-J11  
X-38cm  
Y-180cm  
Z-100cm

NGFP22  
OBJECTO-Percutor  
MATERIAL-  
QUADRADO-J9  
X-  
Y-  
Z-Superficie

NG  
OBJECTO-  
MATERIAL-  
QUADRADO-  
X-  
Y-  
Z-

NG  
OBJECTO-  
MATERIAL-  
QUADRADO-  
X-  
Y-  
Z-

ANTA DA FONTE DA PIPA

NoFP1  
 OBJECTO-Ponta de seta  
 MATERIAL-Silex  
 QUADRADO-J12  
 X-85cm  
 Y-45cm  
 Z-112cm

NoFP2  
 OBJECTO-Ponta de seta  
 MATERIAL-Silex  
 QUADRADO-I12  
 X-  
 Y-  
 Z-100cm

NoFP3  
 OBJECTO-Ponta de seta  
 MATERIAL-Silex  
 QUADRADO-I12  
 X-  
 Y-  
 Z-90cm

NoFP4  
 OBJECTO-Ponta de seta  
 MATERIAL-Silex  
 QUADRADO-I12  
 X-  
 Y-  
 Z-95cm

NoFP5  
 OBJECTO-Ponta de seta  
 MATERIAL-quartzó filoniano  
 QUADRADO-J11  
 X-  
 Y-  
 Z-100cm

NoFP6  
 OBJECTO-Ponta de seta  
 MATERIAL-Silex  
 QUADRADO-J12  
 X-  
 Y-  
 Z-100cm

NoFP7  
 OBJECTO-Ponta de seta  
 MATERIAL-Silex  
 QUADRADO-J11  
 X-25cm  
 Y-100cm  
 Z-85cm

NoFP8  
 OBJECTO-Fragmento de lâmina  
 MATERIAL-Silex  
 QUADRADO-J11  
 X-50cm  
 Y-130cm  
 Z-100cm

NoFP9  
 OBJECTO-Fragmento de lâmina  
 MATERIAL-Silex  
 QUADRADO-J11  
 X-24cm  
 Y-90cm  
 Z-100cm

NoFP10  
 OBJECTO-Fragmento de lâmina  
 MATERIAL-Silex  
 QUADRADO-J11  
 X-95cm  
 Y-75cm  
 Z-100cm

NoFP11  
 OBJECTO-Fragmento de lâmina  
 MATERIAL-Silex  
 QUADRADO-J11  
 X-70cm  
 Y-37cm  
 Z-85cm

NoFP12  
 OBJECTO-Geométrico  
 MATERIAL-Silex  
 QUADRADO-I12  
 X-  
 Y-  
 Z-100cm

**ANTA**  
da  
**LOMBA DA BARCA**



ANTA DA LOMBA DA BARCA

N9LB1  
OBJECTO-Enx6  
MATERIAL-Xisto  
QUADRADO-N13  
X-85cm  
Y-15cm  
Z-125cm

N9LB2  
OBJECTO-Machado  
MATERIAL-Anfibolite  
QUADRADO-N13  
X-85cm  
Y-15cm  
Z-125cm

N9LB3  
OBJECTO-Machado  
MATERIAL-Anfibolite  
QUADRADO-M13  
X-140cm  
Y-25cm  
Z-125cm

N9LB4  
OBJECTO-Objecto indeterminado  
MATERIAL-Quartzo  
QUADRADO-M13  
X-170cm  
Y-110cm  
Z-125cm

N9  
OBJECTO-  
MATERIAL-  
QUADRADO-  
X-  
Y-  
Z-

N9  
OBJECTO-  
MATERIAL-  
QUADRADO-  
X-  
Y-  
Z-





**ANTA**  
**da**  
**NAVE DO PADRE SANTO**



ANTA DA NAVE DO PADRE SANTO

NºPS1  
OBJECTO-Machado  
MATERIAL-Anfibolite  
QUADRADO-F6  
X-  
Y-  
Z-  
(Revolvimento-superficie)

NºPS2  
OBJECTO-Machado  
MATERIAL-Anfibolite  
QUADRADO-G6  
X-12cm  
Y-18cm  
Z-78cm

NºPS3  
OBJECTO-Enxó  
MATERIAL-Anfibolite  
QUADRADO-F6  
X-55cm  
Y-124cm  
Z-90cm

NºPS4  
OBJECTO-Geométrico  
MATERIAL-Silex  
QUADRADO-G6  
X-114cm  
Y-100cm  
Z-91cm

NºPS5  
OBJECTO-Geométrico  
MATERIAL-Silex  
QUADRADO-G6  
X-  
Y-  
Z-90cm  
Crivo

NºPS6  
OBJECTO-Fragmento de elemento de adorno(?)  
MATERIAL-Xisto  
QUADRADO-F7  
X-55cm  
Y-23cm  
Z-65cm

NºPS7  
OBJECTO-Lâmina  
MATERIAL-Silex  
QUADRADO-F6  
X-65cm  
Y-123cm  
Z-87cm

NºPS8  
OBJECTO-Lâmina  
MATERIAL-Silex  
QUADRADO-F8  
X-  
Y-  
Z-  
(Revolvimento-superficie)

NºPS9  
OBJECTO-Ponta de seta  
MATERIAL-Quartzó filoniano  
QUADRADO-G6  
X-  
Y-  
Z-90cm



## ÍNDICE

<b>Nota Explicativa</b>	<b>2</b>
<b>Desenho dos Materiais</b>	<b>6</b>
Anta da Bola da Cera	7
Anta da Cabeçuda	56
Anta das Castelhanas	124
Anta da Figueira Branca	142
Anta dos Pombais	158
Anta I do Alcogulo	188
Anta II do Alcogulo	210
Anta III do Alcogulo	244
Anta I do Cerejeiro	248
Anta I dos Coureleiros	252
Anta II dos Coureleiros	266
Anta III dos Coureleiros	286
Anta IV dos Coureleiros	302
Anta do Galhardo	322
Anta dos Olheiros	326
Anta do Pai Anes	334
Anta do Porto Aivado	344
Anta do Sobral	370
Anta da Tapada de Matos	374
Anta do Tapadão da Relva	446
Anta do Vale da Estrada	488
Menir do Carvalhal	502
Anta da Fonte da Pipa	510
Anta da Lomba da Barca	522
Anta da Nave do Padre Santo	528
<b>Descrição dos Materiais</b>	<b>534</b>
Anta da Bola da Cera	536
Anta da Cabeçuda	566
Anta das Castelhanas	586
Anta da Figueira Branca	596
Anta dos Pombais	606
Anta I do Alcogulo	622
Anta II do Alcogulo	628
Anta I do Cerejeiro	640
Anta I dos Coureleiros	644
Anta II dos Coureleiros	648
Anta III dos Coureleiros	660



Anta IV dos Coureiros	664
Anta do Galhardo	672
Anta dos Olheiros	676
Anta do Pai Anes	680
Anta do Porto Aivado	686
Anta do Sobral	692
Anta da Tapada de Matos	696
Anta do Tapadão da Relva	740
Anta do Vale da Estrada	758
Menir do Carvalhal	765
Anta da Fonte da Pipa	769
Anta da Lomba da Barca	773
Anta da Nave do Padre Santo	777
<b>Índice</b>	<b>781</b>



eA